

OLYMPUS[®]

Your Vision, Our Future

INVERTED SYSTEM MICROSCOPE

IX51

IX2 SERIES



UIS2
World-leading optics

*Practical Convenience and Quality Performance
now enhanced with UIS2 optics*





Excellent optical performance and versatility with uncompromised quality

The IX51 continues the Olympus inverted microscope tradition by providing a very stable, compact platform ready to accept a wide range of accessories and applications. Practical convenience and quality performance are matched by excellent cost efficiency. The slim frame design enables easy attachment of multiple accessories for tissue culture and live cell imaging.

-  *Ergonomic design
Easy operation*
-  *Slim and compact
design saves bench space*

-  *Side camera port accepts
a wide range of CCD
cameras*

-  *Suitable for use with a wide
variety of sample vessels*

-  *Excellent optical performance
and mechanical quality for
outstanding value*

-  *Improved throughput for
fluorescence observations*

-  *Long working distance
condenser accommodates
roller bottles*

-  *Pre-centered phase contrast
slider for 10X-40X
requires no adjustment
(IX2-SLP)*

-  *New optics deliver better-
than-ever image contrast*



Superb optics

Easy to use phase contrast system

- The 30W illumination pillar includes a condenser (N.A. 0.3, W.D. 72mm) with detachable front lens for an ultra long 182mm working distance, accommodating standing laboratory flasks or roller bottles.

Pre-centered phase contrast slider for quick, adjustment-free observation

- With the IX2-SLP pre-centered phase contrast slider, there is no need to center the objective each time the magnification is changed. Additionally, a common condenser annulus for 10X, 20X and 40X objectives eliminates the need to change the slider position. The result is quick and easy phase contrast observations without the need for optical adjustments and efficient throughput of routine tasks. Since the phase plate transmission rates are dictated by the objective in use, image brightness remains constant even when the magnification is changed.

*The IX2-SL with centering mechanism enables maximized phase contrast performance with precise optical adjustments.

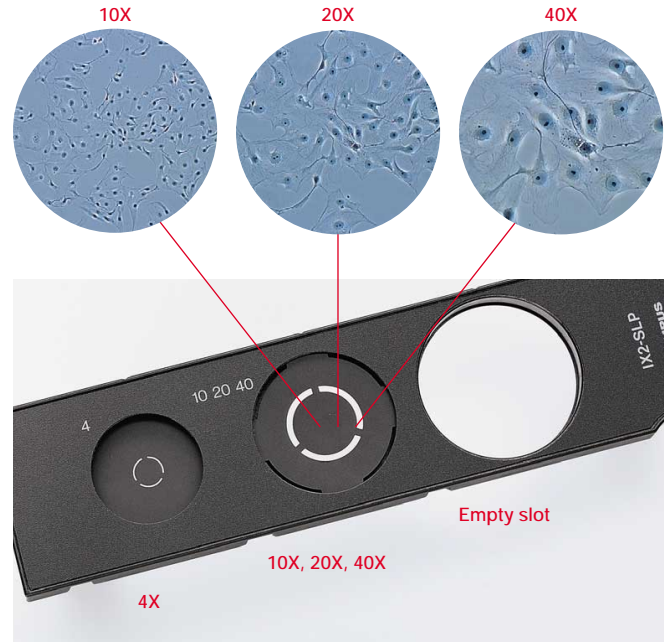

PHC type objective minimally affected by surface tension around the container edge (CPLN10XPH, CPLFLN10XPH, LCACHN20XPH)

- The PHC type 10X and 20X objectives are designed for sharp phase contrast even at the edge of the culture dish, where the meniscus of the culture fluid can compromise other objectives. Easier multi-well observation is one of several benefits. Combined with the improved field flatness resulting from the use of UIS2 optics, this feature facilitates clear observation of cells even at the edges of a dish or well.

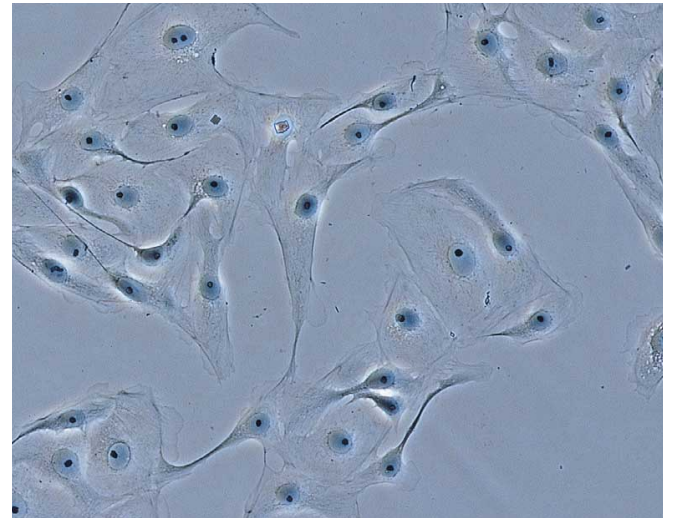
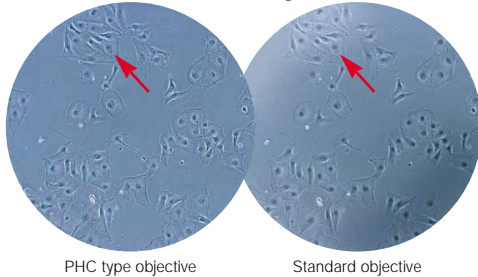

Slim, compact & stable

Plenty of workspace

- The slim, stable, compact design with reduced footprint provides ample bench space for accessories. Shortened height of 30W halogen illumination pillar provides easy installation in a clean bench environment.
- Computer aided design with a unique aluminum alloy cast frame material combine for excellent rigidity and thermal expansion performance.

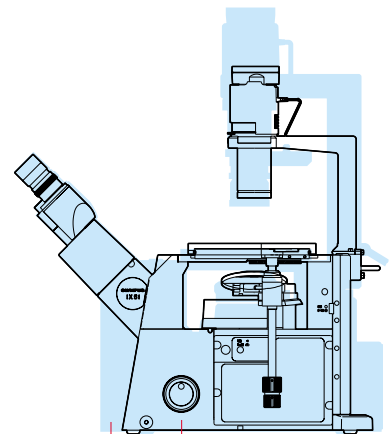
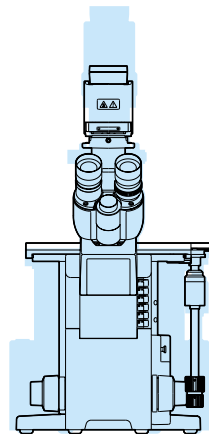
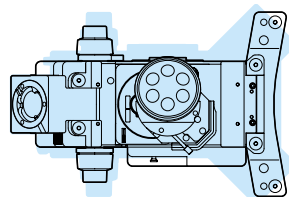

IX IX2

Ergonomics

Easy, convenient operation

- Features to promote fatigue-free operation include a low stage, optional glass stage insert plate and objective color-band labels.
- Various observation tubes are provided to suit a wide range of users including a tilting binocular tube for use while sitting or standing.



Side camera port

- Narrow frame allows a side mounted detector to access the primary image, without relay lenses, providing cameras with the highest quality image, free of aberrations.
- U-DPCAD dual camera port allows the attachment of two cameras, both with access to the primary image, with the possibility of spectral separation.



U-DPCAD double port mounted on the left side port



DP71 mounted on the left side port

Live cell observation

Suitable for use with a wide range of containers

- Optical system includes objectives and condensers to accommodate different vessel types and thicknesses. Stage adapters accommodate a variety of vessels from microscope slides to well plates.



IX2-KSP+CK40-MVR



Gliding stage/IX2-GS

- Designed for applications such as *C. elegans* observation, this stage moves with the touch of a finger, rotating a full 360° with 20mm X-Y travel. The flat design allows for horizontally mounted micromanipulators.



IX2-GS

Plain stage (IX2-SP)+ Mechanical stage (IX-MVR)

- A mechanical stage provides X-Y movement for a variety of sample vessels. Coaxial control knobs are positioned low for user comfort.



IX2-SP+IX-MVR

Cell viability

Stable, constant environment for long-term observations

- External power supply reduces thermal expansion and electrical noise.
- All detents and click stops are designed to minimize vibration.
- For cell viability observations, CO₂ incubators, chambers and a thermoplate are available.



MIU-IBC-I-2 CO₂ incubator with chamber
**Not available in some areas*



Thermoplate



Fluorescence

Excellent fluorescence performance

- High throughput illuminator is 20% brighter than previous models.
- Optional L-Shaped Illuminator includes aperture and field stops and convenient access to burner centration.
- Fluorescence mirror units are designed to reduce stray light and image flare.
- Six position filter turret for maximum system flexibility.
- Improved filter performance with high efficiency coatings designed for low background and minimal crossover.



IX2-RFA



IX2-RFAL

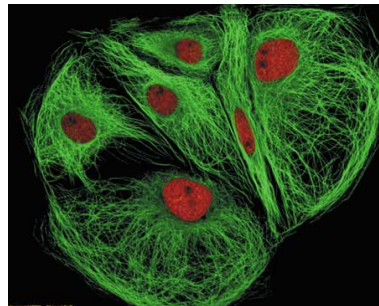

Accessories

- An illumination pillar for a 100W halogen lamphouse allows bright, high N.A. relief contrast and DIC observations through the use of optional condensers.
- The ultra-long working distance condenser (N.A. 0.3, W.D. 73mm) with four position turret can be combined with the 100W illumination pillar for brighter 4X to 40X phase contrast and brightfield observations.



IX-ULWCD

IX51 SYSTEM DIAGRAM

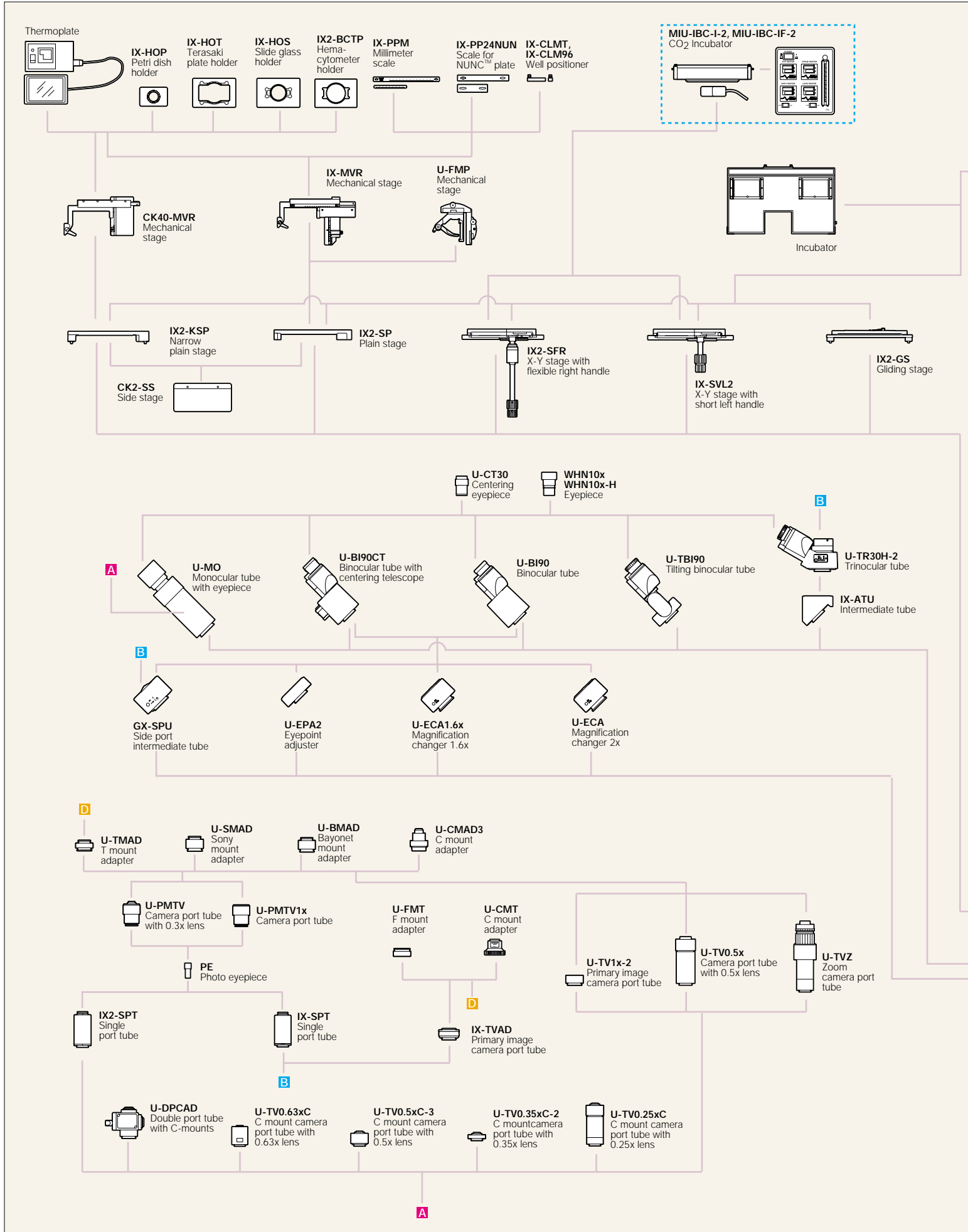

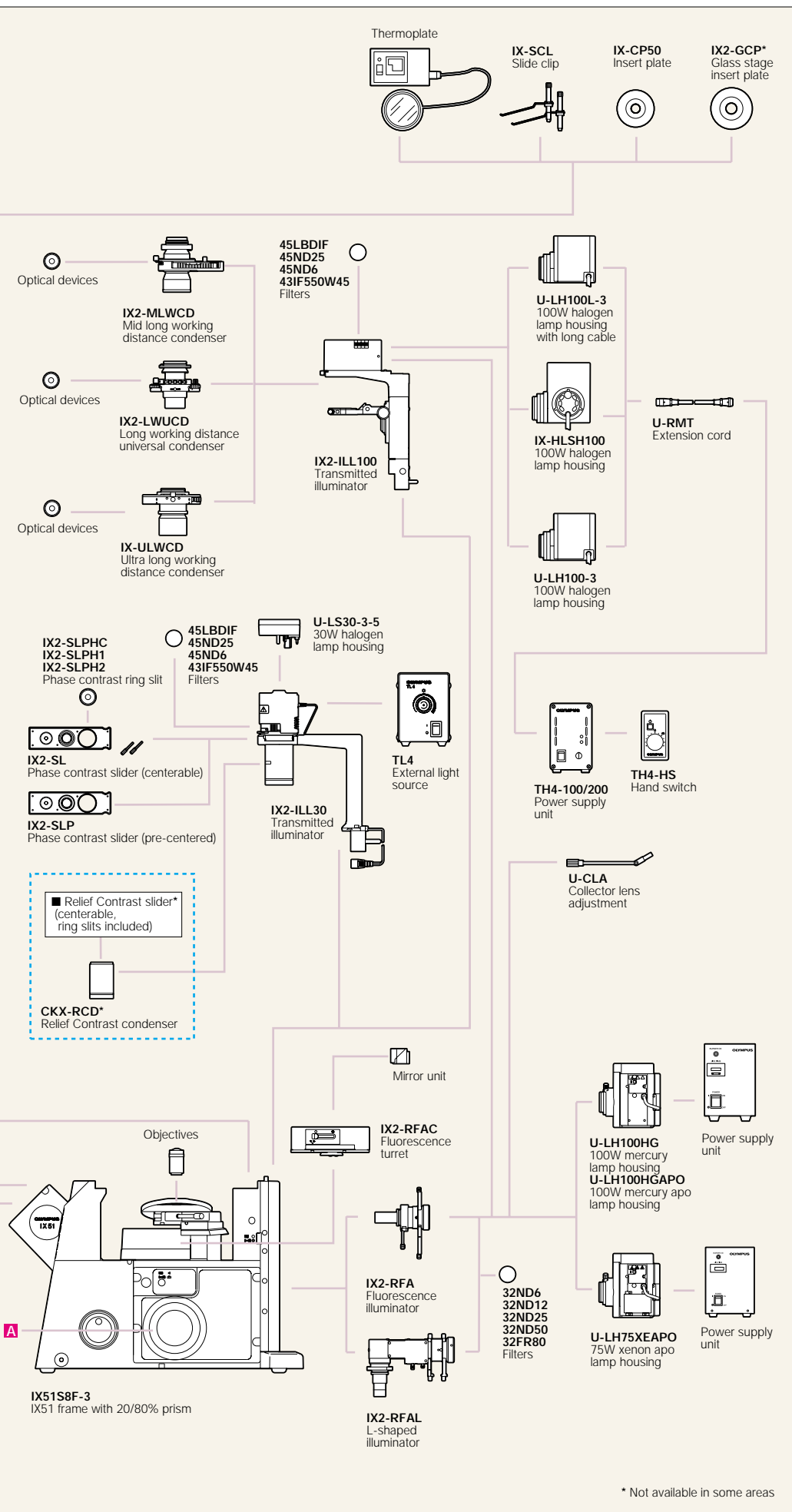

UIS2 objectives

Objective	N.A.	W.D.(mm)	Remarks	
For brightfield	PLCN4X	0.10	18.5	
	PLCN10X	0.25	10.6	
	PLCN20X	0.40	1.2	
	LUCPLFLN40X	0.60	2.7-4	
For phase contrast	UPLFLN4XPH	0.13	17	PHL (for use with IX2-SL)
	CPLN10XPH	0.25	10	PHC (for use with IX2-SL)
	PLN10XPH	0.25	10.6	PH1 (for use with IX2-SL)
	LCACHN20XPH	0.40	3.2	PHC (for use with IX2-SL)
	LUCPLFLN20XPH	0.45	6.6-7.8	PH1 (for use with IX2-SL)
	LCACHN40XPH	0.55	2.2	PH2 (for use with IX2-SL)
	LUCPLFLN40XPH	0.6	3.0-4.2	PH2 (for use with IX2-SL)
	UPLFLN4XPH*	0.13	16.4	For use with IX2-SLP
	CACHN10XPH*	0.25	8.8	For use with IX2-SLP
	LCACHN20XPH*	0.40	3.2	For use with IX2-SLP
LCACHN40XPH*	0.55	2.2	For use with IX2-SLP	
For RC	CPLN10XRC	0.25	9.7	For use with IX2-MLWCD
	LCACHN20XRC	0.40	2.8	For use with IX2-MLWCD
	LCACHN40XRC	0.55	1.9	For use with IX2-MLWCD
For FL	UPLFLN4X	0.13	17	U,B,G
	UPLFLN10X	0.30	10	U,B,G, w/ND filter
	UPLFLN20X	0.50	2.1	U,B,G
	LUCPLFLN20X	0.45	6.6-7.8	U,B,G
LUCPLFLN40X	0.6	2.7-4	U,B,G	

* Pre-centering objective

• All UIS2 objectives and WHN eyepieces: lead-free eco-glass

* Not available in some areas

IX51 specifications

Microscope body	Revolving nosepiece	Sextuple, simple waterproof mechanism incorporated
	Focus	9mm stroke (from stage surface, 7mm upward and 2mm downward), coaxial coarse and fine focusing knobs (minimum fine focus graduation: 1µm, full rotation of fine focusing knobs: 100µm), upper limit stopper, torque adjustment for coarse focusing
	Left side port	2-step light path selection
Transmitted light illuminator	30W HAL illumination	IX2-ILL30 + U-LS30-3-5 Detachable condenser lens system (N.A. 0.3 W.D. 72mm), single filter holder (45mm, t=11mm or less), aperture iris diaphragm adjustable
	External power supply unit	TL-4 Auto voltage selector (100V / 200V)
	100W HAL illumination	IX2-ILL100 + U-LH100L-3 Pillar tilt mechanism (30° inclination angle, with vibration reducing mechanism), Condenser holder (with 50mm stroke, swing-in/out mechanism), Field iris diaphragm adjustable, 4 filter holders (45mm, t=6mm or less)
Observation tube	External power supply unit	TH4-100/200 Two versions available (100V and 200V)
	Tilting binocular tube	U-TBI90 35-85° continuous angle adjustable (eyepoint height range : 406mm-471mm), interpupillary distance adjustable between 50-76mm, diopter adjustment function, erect image, F.N. 22
	Binocular tube	U-BI90CT Built-in focusing telescope, interpupillary distance adjustable 50-76mm, diopter adjustment function, F.N. 22
Stage	U-BI90	Interpupillary distance adjustable 50-76mm, diopter adjustment function, F.N. 22
	Trinocular tube	U-TR30H-2 + IX-ATU 3 step optical path selectable (observation : straight port = 100:0, 20:80, 0:100), interpupillary distance adjustable 50-76mm, diopter adjustment function, F.N. 22
	Cross stage with flexible right handle	IX2-SFR 50mm(X) X 50mm(Y) stroke, stage insert plate exchangeable (ø110mm)
	Cross stage with short left handle	IX-SVL2 50mm(X) X 43mm(Y) stroke, stage insert plate exchangeable (ø110mm)
	Plain stage	IX2-SP 232mm(X) X 240mm(Y) stage size, stage insert plate exchangeable (ø110mm)
	IX-MVR	Mechanical stage to be used with IX2-SP, 130mm(X) X 85mm(Y) stroke
	Narrow plain stage	IX2-KSP 160mm(X) X 240mm(Y) stage size, stage insert plate exchangeable (ø110mm)
Condenser	CK40-MVR	Mechanical stage to be used with IX2-KSP, 120mm(X) X 78mm(Y) stroke
	Gliding stage	IX2-GS Upper circular stage 360° rotatable, 20mm(X/Y) travel
	Ultra long working distance	IX-ULWCD 4 positions for optical devices (for ø29mm), aperture iris diaphragm adjustable, N.A. 0.3 / W.D. 73mm
Long working distance universal	IX2-LWUCD	5 positions for optical devices (3 positions for ø30mm and 2 position for ø38mm), aperture iris diaphragm adjustable, N.A. 0.55 / W.D. 27mm
	IX2-MLWCD	4 positions for optical devices (for ø50mm, optical Relief Contrast optical devices rotatable), aperture iris diaphragm adjustable, N.A. 0.5 / W.D. 45mm
Eyepiece	WHN10X	High eyepoint, F.N. 22
	WHN10X-H	High eyepoint, diopter adjustment function, F.N. 22
Reflected light fluorescence unit	Fluorescence illuminator	IX2-RFAL L-shaped design with exchangeable F.S. and A.S. modules, two filter holder sliders (2 positions, ø32mm, t=6mm or less)
	IX2-RFA	Straight design with field iris diaphragm, filter holder slider (2 positions, ø32mm, t=6mm or less)
	Fluorescence cube turret	IX2-RFAC 6 positions in a rotating turret, built-in shutter 100W Hg lamp housing and transformer, or 75W Xe lamp housing and transformer

IX51 30W illumination pillar version dimensions

(unit: mm)

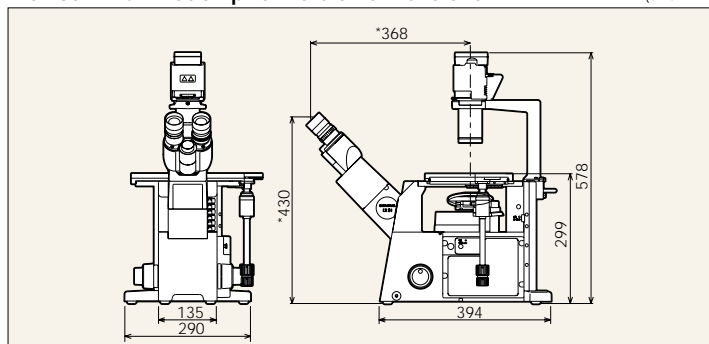

Weight: 20.5kg Length marked with an asterisk (*) may vary according to interpupillary distance.

IX51 100W illumination pillar version dimensions

(unit: mm)

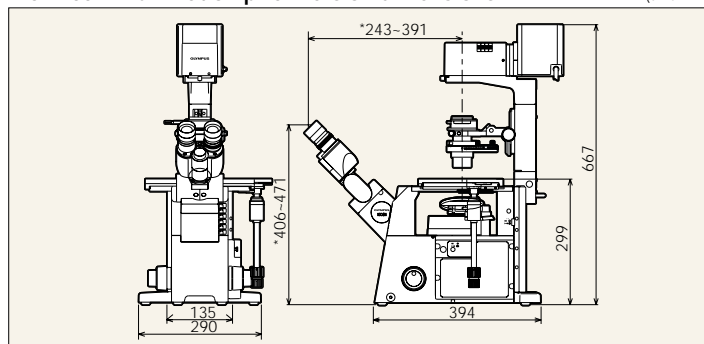

Weight: 24.4kg Length marked with an asterisk (*) may vary according to interpupillary distance.

TL4 dimensions

(unit: mm)

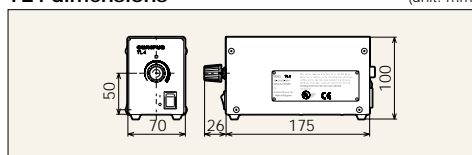

Weight: 0.8kg
Rated voltage: 55VA

TH4 dimensions

(unit: mm)

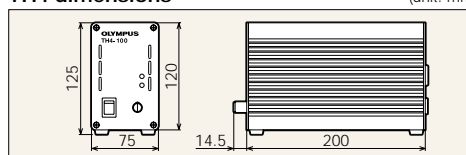

Weight: 2.2 kg
Rated voltage: 200VA



IX51 is the environmental conscious product according to OLYMPUS's own standards.

Main features of OLYMPUS Eco-products are as follows.

- Lead-free and arsenic-free Eco-glass for optics, such as lenses and prisms.
- Adoption of cardboard for packing materials without styrene foam for promoting the recycling.
- Some accessories are inapplicable.

Please visit our web site for further information:
<http://www.olympus.co.jp/en/eco-products/>

ECO-PRODUCTS



ISO9001 Certification
OLYMPUS CORPORATION Micro-Imaging System Division



ISO14001 Certification
OLYMPUS CORPORATION Ina-Plant



ISO9001/ISO14001 Certification
Olympus Optical Technology Philippines Inc.

OLYMPUS CORPORATION obtains ISO9001/ISO14001

Specifications are subject to change without any obligation on the part of the manufacturer.

OLYMPUS

OLYMPUS CORPORATION
Shinjuku Monolith, 3-1, Nishi Shinjuku 2-chome, Shinjuku-ku, Tokyo, Japan
OLYMPUS LIFE AND MATERIAL SCIENCE EUROPA GMBH
Postfach 10 49 08, 20034, Hamburg, Germany
OLYMPUS AMERICA INC.
3500 Corporate Parkway, Center Valley, Pennsylvania 18034-0610, U.S.A.
OLYMPUS SINGAPORE PTE LTD.
491B River Valley Road, #12-01/04 Valley Point Office Tower, Singapore 248373
OLYMPUS AUSTRALIA PTY. LTD.
31 Gilbey Road, Mt. Waverley, VIC 3149, Melbourne, Australia.

OLYMPUS LATIN AMERICA, INC.
5301 Blue Lagoon Drive, Suite 290 Miami, FL 33126, U.S.A.
OLYMPUS (BEIJING) SALES & SERVICE CO., LTD.
12-13F, NCI Tower, A12 Jianguomenwai Avenue, Chaoyang District, Beijing, 100022, China



This catalog is printed by environmentally-friendly waterless printing system with soy ink.

www.olympus.com

Printed in Japan M3500E-0706B