

FV1000MPE specifications

		B system	S system	T system	M system
Laser unit	IR pulsed laser with negative chirp for multiphoton excitation	<ul style="list-style-type: none"> <li>Mode-locked Ti:sapphire laser (femtosecond laser (equipped with a group velocity compensation)), laser power unit, water-cooled circulating chiller</li> <li>IR pulsed laser can be controlled with the FV10-ASW (ver.2.1 or later) software</li> <li>MaiTai BB DeepSee-OL, MaiTai HP DeepSee-OL or MaiTai eHP DeepSee-OL (Spectra-Physics products)                             <ul style="list-style-type: none"> <li>MaiTai BB DeepSee-OL: 710 nm — 990 nm</li> <li>MaiTai HP DeepSee-OL: 690 nm — 1040 nm</li> <li>MaiTai eHP DeepSee-OL: 690 nm — 1040 nm (70 femtoseconds at a specimen plane)</li> </ul> </li> <li>Chameleon Vision I-OL, Chameleon Vision II-OL (Coherent products)                             <ul style="list-style-type: none"> <li>Chameleon Vision I-OL: 690 nm — 1040 nm</li> <li>Chameleon Vision II-OL: 680 nm — 1080 nm</li> </ul> </li> </ul>			
	Visible light laser AOTF laser combiner	LD laser: 405 nm: 50 mW, 440 nm: 25 mW, 473 nm 15 mW, 559 nm 15 mW, 635 nm 20 mW Multi Ar laser (458 nm, 488 nm, 515 nm, Total 30 mW), HeNe (G) laser (543 nm, 1 mW) Modulation: Continuously adjustable via an AOTF (0.1 — 100% in 0.1% increments) •Operating mode: Allows laser turn-off during the retrace period REX: adjustment of laser power for each region, and selection of the laser and selection of the laser wavelength •Visible light laser platform with implemented AOTF system, ultra-fast intensity with individual laser lines, additional shutter control, Connected to scanner via single-mode fiber •Equipped with laser feedback mechanism to limit changes in laser light intensity over time			
	Single laser for visible light	LD473 laser (15 mW) Depending on the type of modulation: light intensity modulation, shutter control, connected to the scanner via single-mode optical fiber			
Scanning unit	Scanning method	•Light deflection via 2 galvanometer scanning mirrors			
	Scanning modes	•Pixel size: 64 x 64 — 4096 x 4096 pixels Scanning speed: (pixel time): 2 μs — 200 μs High-speed scanning mode: 16 frames/s (256 x 256) •Dimensions: Time, Z, (wavelength) (or any combination thereof) •Line scan: straight line (includes rotation), free line, point XY scan			
	Zoom size	Observation position zoom with inclination width modification of galvanometer mirror: 1—50X (adjustable in 0.1X increments)			
Confocal detector (The M scanner does not have a confocal detector)	•Detector: 3 channels for fluorescence detection (photomultipliers), optional 4CH detector for expansion •Dichromatic mirrors for excitation, dichromatic mirrors for multiphoton excitation, dichromatic mirrors for fluorescence, emission filter •Infrared cut filter: using a high-performance filter •A filter or spectral type of fluorescence detector can be selected Spectral type: Channels 1 and 2 provided with independent grating and slit Selectable wavelength range: 1 – 100 nm, wavelength resolution: 2 nm, wavelength switching speed: 100 nm/ms •Pinhole: Single motorized pinhole, pinhole diameter: ø50 – 800μm (spectral type ø50 – 300 μm), adjustable in 1 μm increments •Field Number: 18				
	•Integrates a multiphoton near-infrared pulsed laser in the scanning unit (Laser safety measures implemented) •Continuously variable output using AOM (0.1 – 100%, 0.1% increments)				
Optics with infrared laser for multiphoton imaging					
Component incorporating the laser for multiphoton imaging	Main scanner for observation	ASU scanner for laser light stimulation, Main scanner for observation: VIS laser	Incorporating 2 independent lasers for laser light stimulation/observation	M scanner for observation	
Detector for multiphoton imaging	Reflected light fluorescent detector	Photomultiplier (2 or 4 channels), Fluorescence wavelength can be selected with the dedicated filter cube (replaceable)			
	Transmitted light fluorescent detector	Photomultiplier (2 channels), Fluorescence wavelength can be selected with the dedicated filter cube (replaceable) (not combinable with IX-SVL2) Exclusive equipment for the BX61WI upright microscope			
Transmitted DIC unit	•Integrated transmitted light detector and transmitted illuminator, Motorized switching Connected to microscope via fiber cable (IR-DIC observation using an infrared laser is not possible)				
Z-drive	•A motorized focus module inside the microscope is used •Minimum increment: 0.01 μm				
Microscope	Upright microscopes: BX61WI, BX61 Inverted microscope: IX81				
System control	•OS: WindowsXP Professional (English version), WindowsVista (English version) •CPU: Core2Duo 3.0 GHz •Memory: 2.0 GB or larger •Hard disk: 500 GB or larger •Dedicated I/F board: built-in PC •Graphics board: Open GL-compliant •Recording media: Equipped with DVD dual drive				
Software	FV10-ASW Ver.2.0 or later				
Required installation environment	Room temperature: 20 – 25°C, humidity: 75% or less@25°C, requires continuous (24-hour) power supply				
Vibration isolation table for microscope and laser installation, size	1500 mm x 1250 mm	1500 mm x 1500 mm	1700 mm x 1700 mm	1500 mm x 1250mm	

**OLYMPUS**<sup>®</sup>

Your Vision, Our Future

Multiphoton Laser Scanning  
Microscope

**FV1000MPE**

FLUOVIEW

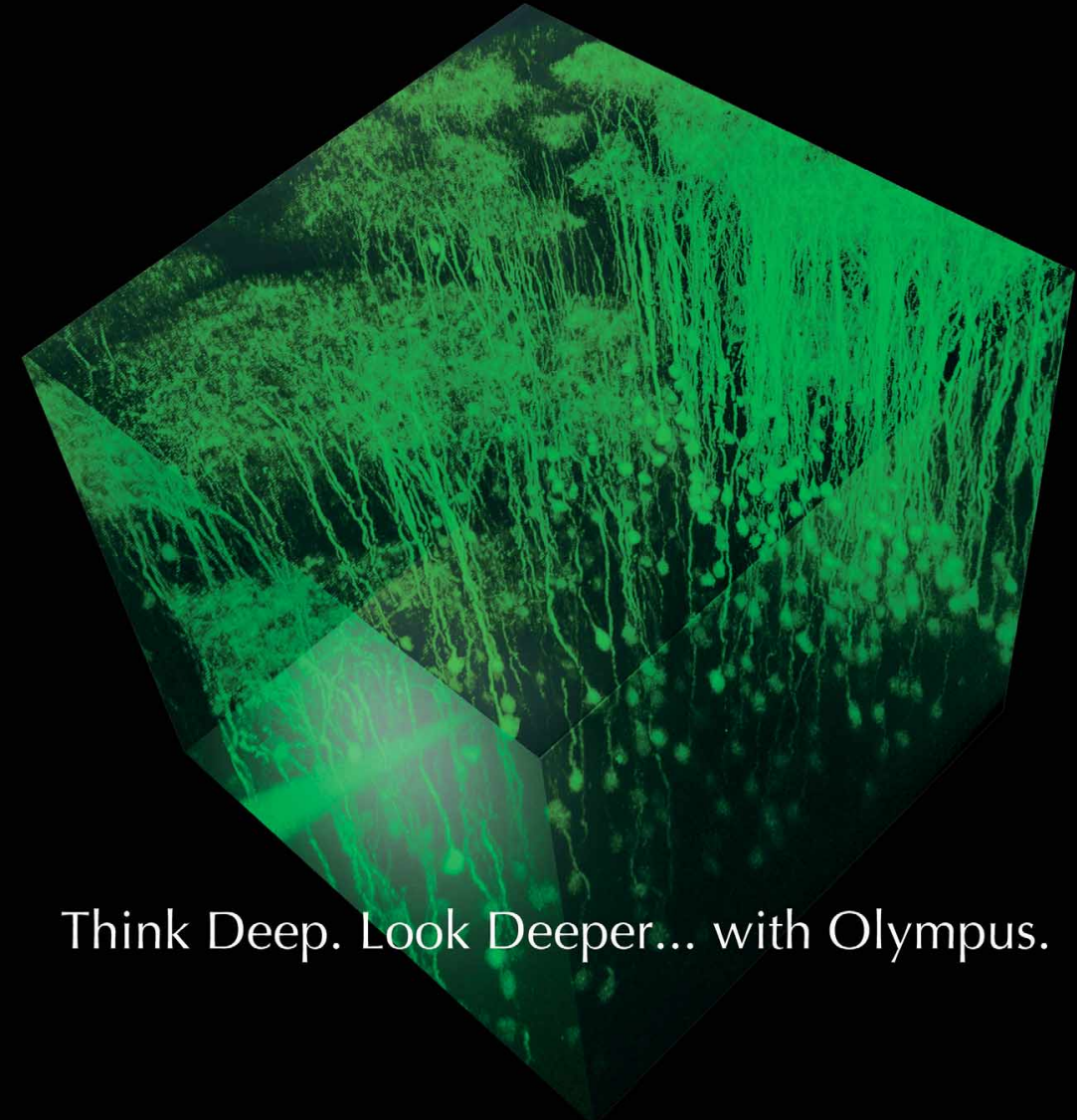

Think Deep. Look Deeper... with Olympus.



The use of lasers with SUB-PICOSECOND pulses for two-photon microscopy is protected by US Pat No. USP5034613, JP Pat No. JP2848952B2, EU Pat No. EP500717B2, EU Pat No. EP807814B1. This technology is under a license from Carl Zeiss MicroImaging GmbH and Cornell Research Foundation Inc. Performance and safety are no longer guaranteed in the event this product is disassembled or modified.

Cover page image data provided by:  
Kei Eto, Hiroyuki Inada, Yusuke Takatsuru, Hiroaki Waki, Tomomi Nemoto, and Junichi Nabekura  
National Institute for Physiological Sciences, National Institutes of Natural Sciences, Japan

- OLYMPUS CORPORATION has obtained the ISO9001/ISO14001.
- Illumination devices for microscope have suggested lifetimes. Periodic inspections are required. Please visit our web site for details.

• Windows is a registered trademark of Microsoft Corporation in the United States and other countries. All other company and product names are registered trademarks and/or trademarks of their respective owners.  
• Specifications and appearances are subject to change without any notice or obligation on the part of the manufacturer.

**OLYMPUS**<sup>®</sup>

**OLYMPUS CORPORATION**  
Shinjuku Monolith, 3-1, Nishi Shinjuku 2-chome, Shinjuku-ku, Tokyo, Japan  
**OLYMPUS LIFE SCIENCE EUROPA GMBH**  
Postfach 10 49 08, 20034, Hamburg, Germany  
**OLYMPUS AMERICA INC.**  
3500 Corporate Parkway, Center Valley, Pennsylvania 18034-0610, U.S.A.  
**OLYMPUS SINGAPORE PTE LTD.**  
491B River Valley Road, #12-01/04 Valley Point Office Tower, Singapore 248373

**OLYMPUS AUSTRALIA PTY. LTD.**  
31 Gilby Road, Mt. Waverley, VIC 3149, Melbourne, Australia.  
**OLYMPUS LATIN AMERICA, INC.**  
5301 Blue Lagoon Drive, Suite 290 Miami, FL 33126, U.S.A.  
**OLYMPUS (CHINA) CO., LTD.**  
12F, NCI Tower, A12 Jianguomenwai Avenue, Chaoyang District, Beijing, 100022, China

www.olympus.com

Printed in Japan M1673E-1109B



**UIS2**  
World-leading optics

## Brighter and deeper imaging with better resolution.

The Olympus FV1000MPE multiphoton laser scanning microscope is renowned for its ability to offer bright, clear imaging deep within specimens.

This is thanks to its optical design, which allows optimized for efficient multiphoton excitation and signal detection.

By closely adhering to optics principles and designing a microscope that is both compact and easy to use, Olympus developed the new FV1000MPE so all researchers can use the microscope to perform deep tissue observation.

With its "brighter and deeper imaging with better resolution," the FV1000MPE opens up greater discovery.

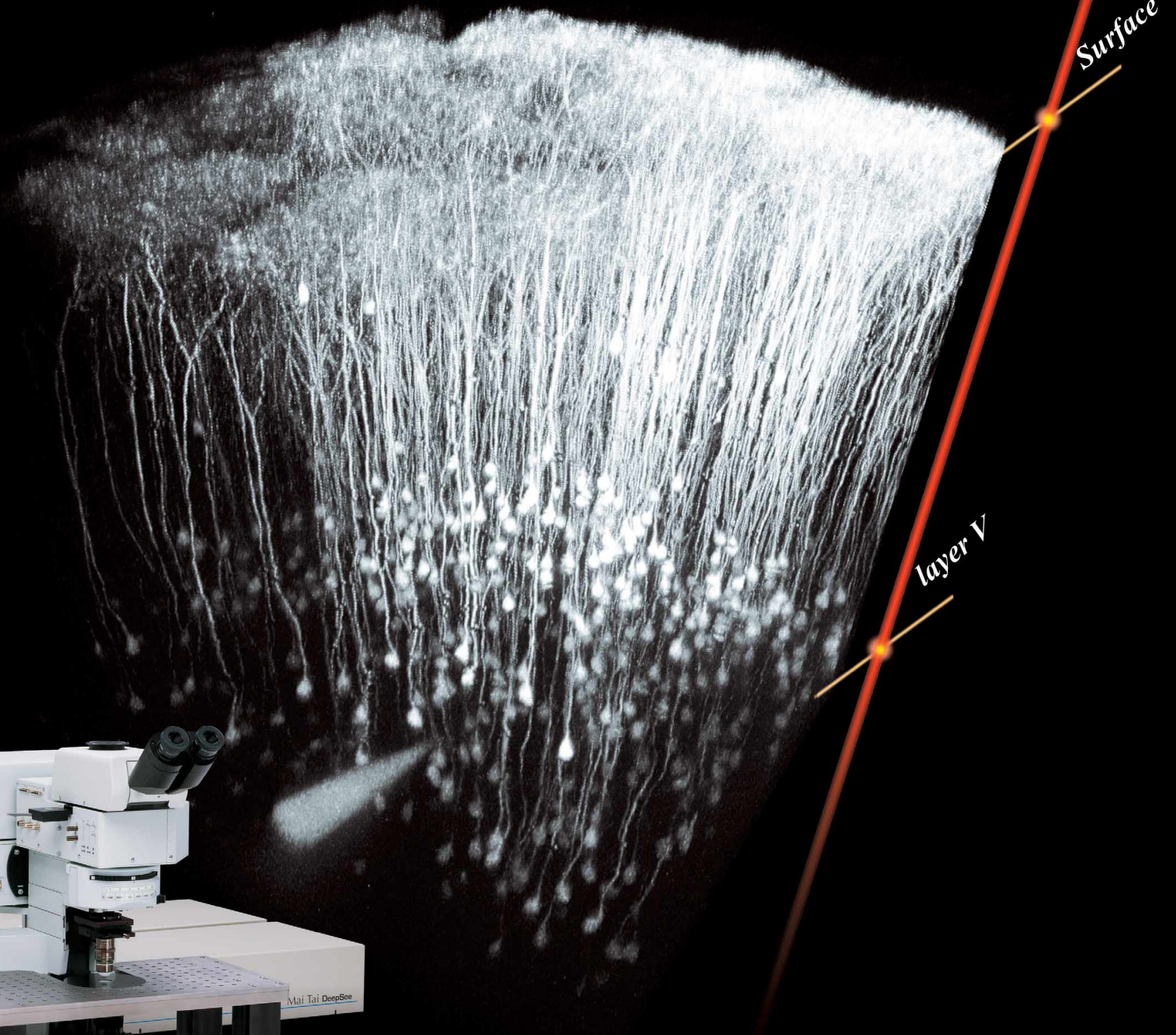

*In vivo* image of neurons expressing YFP in the mouse brain.

The FV1000MPE allows observation at the depths of 0.8 mm or more from the tissue surface, down to layer 5 in the mouse cerebral cortex. Images acquired *in vivo* were rendered in 3 dimensions and tilted for display.

Objective: XLPLN25XWMP

Image data provided by:  
Kei Eto, Hiroyuki Inada, Yusuke Takatsuru, Hiroaki Waki, Tomomi Nemoto, and Junichi Nabekura  
National Institute for Physiological Sciences, National Institutes of Natural Sciences, Japan

# With optical design optimized for efficient multiphoton excitation, the FV1000MPE allows bright, high-resolution observation deep within specimens without damaging them.

Laser unit IR pulsed laser with negative chirp for multiphoton excitation

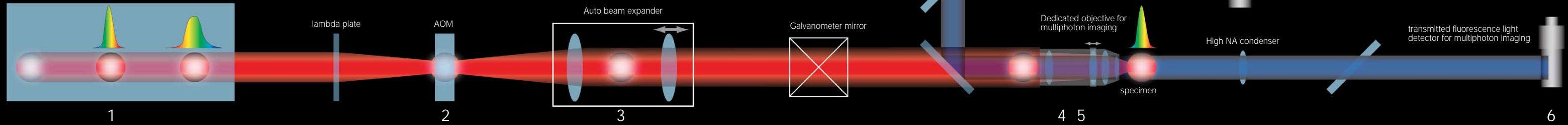

## 1 Brighter and deeper imaging with less damage.

In multiphoton microscopy, the efficiency of fluorescence excitation is maximized by using the shortest pulse width in the focal plane. However, the pulse width of a femtosecond laser disperses as it passes through optics, broadening the pulse width when the beam exits from an objective. The FV1000MPE laser beam-shaping optics establishes a compensatory dispersion, the exact inverse of that produced by the microscope's optics (negative chirp), thus restoring the ideal pulse width for the specimen.

## 2 Custom light adjustment for the exiting laser beam.

The FV1000MPE is equipped with an AOM to adjust laser light. The AOM allows changes in laser intensity and rapid ON/OFF switching of the laser. This provides laser output control to restrict irradiation to the region of interest, avoiding surrounding areas. In thick specimens, laser intensity can be adjusted with specimen depth allowing image capture without changes in image brightness.

## 3 Auto-adjustment of the beam in accordance with the excitation wavelength and objective.

To achieve efficient multiphoton excitation, the laser beam, described by a Gaussian distribution of intensity, must fill the pupil diameter as it enters the objective. The beam expander of the FV1000MPE automatically adjusts the beam diameter depending on the objective and excitation wavelength. This optimizes laser beam characteristics for multiphoton excitation microscopy.

## 4 Correcting for light refraction in the specimen and providing deep imaging.

Refraction index differences within the specimen of itself create a problem in deep imaging by disrupting the focal spot. The FV1000MPE's dedicated objective compensates for the refractive index mismatches thanks to its correction collar, allowing the formation of an ideal focal spot deep within the specimen without loss of energy density.

## 5 Wide field of view design to detect fluorescence with no loss of scattered light.

In multiphoton excitation, fluorescence is emitted from the focal spot inside the specimen. Cells and tissue components scatter light such that it emerges from the surface of the specimen at some distance from the incident beam. Incorporating a wide field of view, the FV1000MPE can capture the maximum amount of fluorescent signal, including scattered light, to provide highly efficient fluorescence imaging in scattering tissue.

## 6 Even brighter in-depth observation with transmitted light detection.

A transmitted fluorescence light detector for multiphoton imaging with a dedicated high N.A. condenser detects transmitted fluorescence as well as transmitted laser light and forward scattered fluorescence. These additions allow extremely bright fluorescence imaging deep within a specimen and is especially effective for second harmonic generation (SHG) imaging.

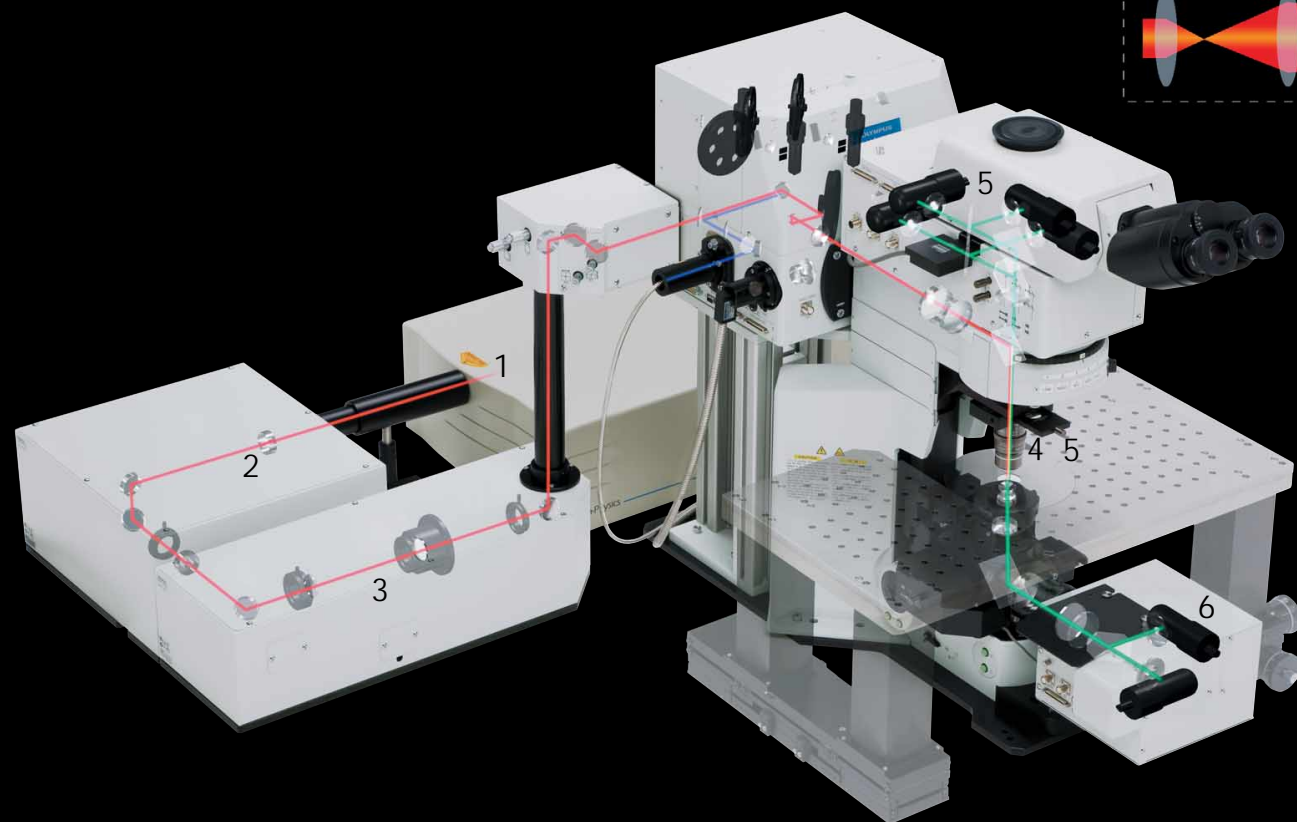
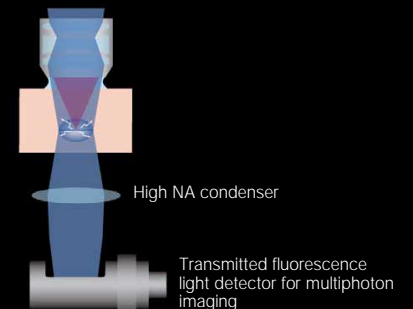
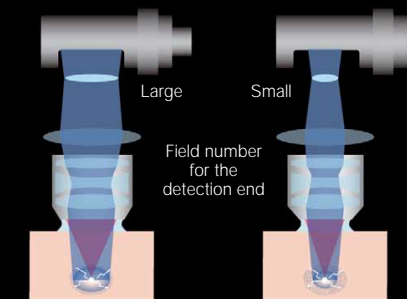
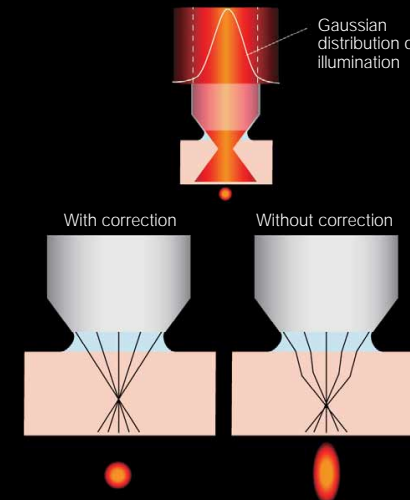
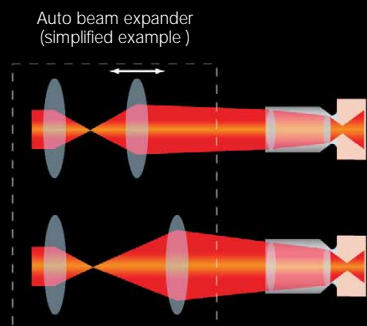

### Dedicated objective for multiphoton imaging

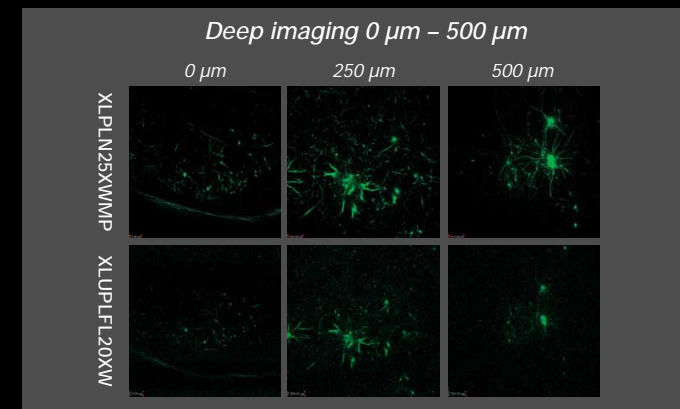

*In vivo* microscopy images of a mouse brain expressing GFP in cerebral cortex neurons.  
Image data provided by:  
Hiroaki Waki, Tomomi Nemoto, and Junichi Nabekura  
National Institute for Physiological Sciences, National Institutes of Natural Sciences, Japan

### Multiphoton transmitted fluorescence observations

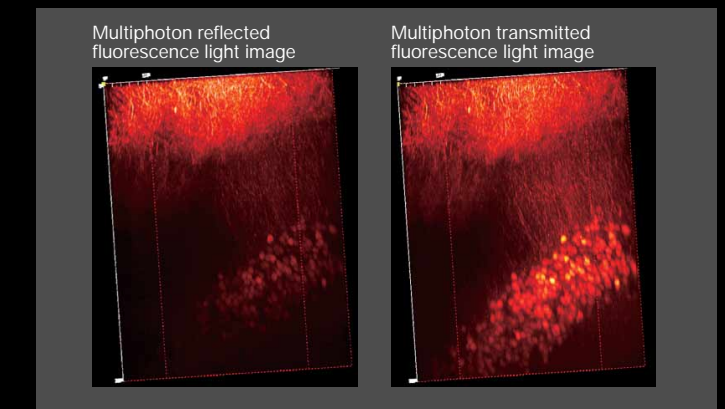
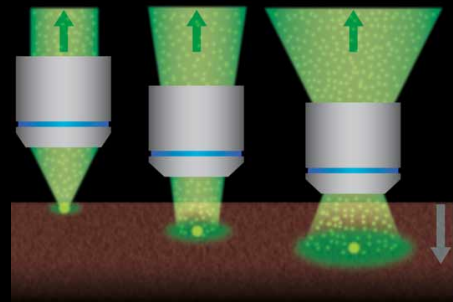

Image of 500  $\mu\text{m}$  thick mouse brain slice specimen.  
Specimen provided by:  
Hiroaki Waki, Tomomi Nemoto, and Junichi Nabekura  
National Institute for Physiological Sciences, National Institutes of Natural Sciences, Japan

## XLPLN25XWMP, dedicated objective with exceptional brightness and resolution for multiphoton imaging.

This water immersion objective with a high N.A. and wide field of view design has improved near-infrared transmittance to optimize multiphoton fluorescence microscopy. The correction collar minimizes spherical aberration caused by refractive index differences between water and the specimen. This allows the formation of a tightly focussed spot without reducing energy density during deep imaging. Its wide field of view design, capturing scattered fluorescence, allows extremely bright, high-resolution fluorescence microscopy. In addition, it provides an approach angle of 35 degrees while maintaining a high N.A., allowing easy access to execute simultaneous patch clamping and imaging.



### Wide field of view.

Despite efficient excitation, fluorescence is scattered deep within the specimen. This widefield objective can collect scattered fluorescence to brighter images.

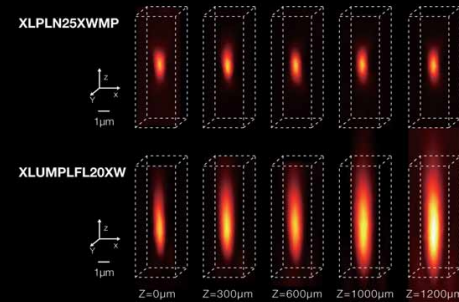

### Highly focused light deep within the specimen.

In this example, fluorescent microspheres 0.5  $\mu\text{m}$  in diameter were observed in a highly refractive medium. Axial resolution has been markedly improved compared to conventional 20X objective.

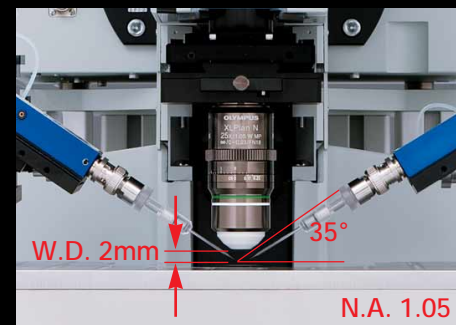

### Sharp approach angle.

An approach angle of 35 degrees provides easy access for patch clamping. Use of this dedicated objective for multiphoton imaging allows simultaneous imaging and patch clamp recordings.

### High sensitivity, high resolution.

The power of the XLPLN25XWMP shines particularly in deep imaging. The objective allows extremely bright, high-resolution fluorescence microscopy deep within the specimen that is not readily observed with a conventional water immersion objective.

*In vivo* microscopy images of a mouse brain expressing GFP in cerebral cortex neurons.

Specimens provided by: Hiroaki Waki, Tomomi Nemoto, and Junichi Nabekura National Institute for Physiological Sciences, National Institutes of Natural Sciences, Japan

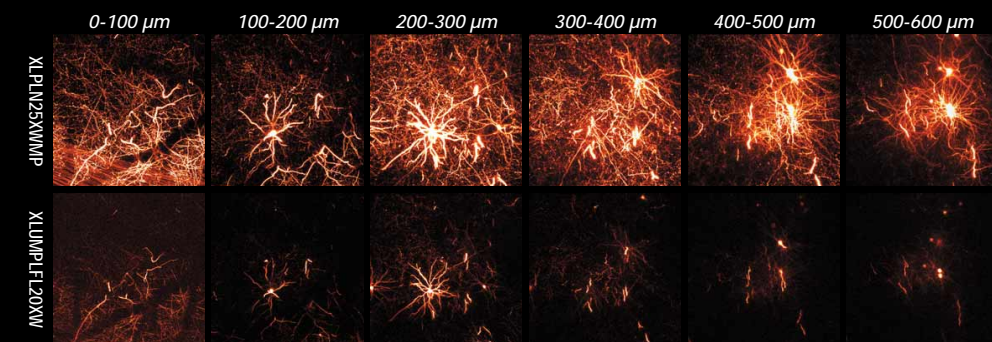

### Objectives for BX61WI

	Numerical Aperture	Working Distance (mm)
MPLN5X	0.10	20.0
UMPLFLN10XW	0.30	3.5
UMPLFLN20XW	0.50	3.5
LUMPLFLN40XW	0.80	3.3
LUMPLFLN60XW	1.00	2.0
LUMFLN60XW	1.10	1.5
XLUMPLFLN20XW*	1.00	2.0
XLPLN25XWMP*	1.05	2.0
UPLSAPO60XW	1.20	0.28

\*Exclusively for BX61WI configuration

### Objectives for IX81

	Numerical Aperture	Working Distance (mm)
UPLSAPO10X2	0.40	3.1
UPLSAPO20X	0.75	0.6
UPLSAPO40X2	0.95	0.18
UPLFLN 40XO	1.30	0.2
UPLSAPO60XO	1.35	0.15
UPLSAPO60XW	1.20	0.28

## Fluorescence detectors for high-sensitivity multiphoton imaging.

### Reflected fluorescence light detector.

Fluorescent signals are not only extremely faint, but also scatter within a thick specimen, causing further decay in signal intensity. The FV1000MPE uses a detector installed at a position as close as possible to the specimen in order to maximize detection efficiency. Because multiphoton excitation is restricted to the focal plane, the emitted fluorescence does not need to pass through a confocal aperture (pinhole). This allows high-sensitivity imaging minimizing light loss due to scattering.

- In addition to the standard 2channel type equipped with 2 photomultiplier tubes, a 4channel reflected fluorescence light detector for multiphoton imaging is available. All detectors are located equidistant from the specimen and allow bright, high-sensitivity multicolor imaging.

- Olympus' own high-performance filter is used for wavelength separation. It can be replaced with other filters depending on the fluorescence characteristics of the specimen.

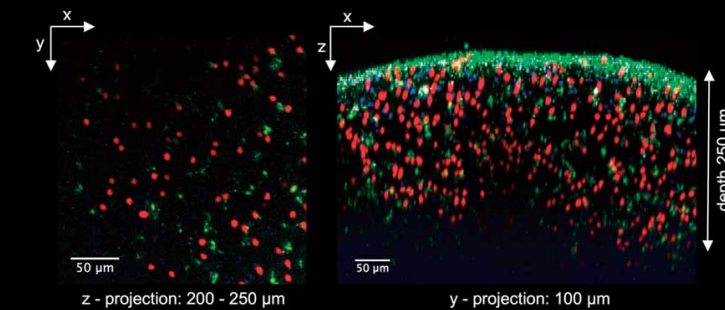

Two-Photon imaging of an explanted lymph node following transfer of B lymphocytes labeled with either SNARF (red) or CMAC (blue).

The transferred cells and autofluorescence (green) can be observed through the collagen rich capsular region to a depth greater than 250  $\mu\text{m}$ . The left panel depicts the z-projection of an image stack at between 200 and 250  $\mu\text{m}$  depth. The right panel shows the 100  $\mu\text{m}$  y-projection of the same stack resliced along the xz-plane.

Excitation at 800 nm, objective XLPLN 25XWMP, NA 1.05.

Julia Eckl-Dorna, Patricia Barral, Andreas Bruckbauer, Facundo Batista Cancer Research UK, London Research Institute, London, UK

### transmitted fluorescence light detector.

A high N.A. condenser and transmitted fluorescence light detector for multiphoton imaging detect fluorescence emitted from the focal plane and light scattered within the specimen. With this transmitted light detector, fluorescence can be detected with a high level of efficiency, especially in deep layers of the specimen.

- The transmitted fluorescence light detector has 2 channels. These 2 channels can be used to detect fluorescence or SHG. Taking into account the reflected fluorescence light detector, FV1000MPE allows maximum 6-channel simultaneous acquisition.

- Two types of dichromatic mirrors are available: one is a fluorescence collection type for wavelength separation in 2 channels and another for fluorescence and SHG (475 nm).

- Two types of condensers are available: one with an oil top lens for high N.A. (NA 1.45) and another with a dry top lens (NA 0.8).

- Switching between transmitted light fluorescence detection and DIC observation is easy. This is optimal for patch clamping (transmitted light fluorescence detection and DIC observation cannot be performed simultaneously).

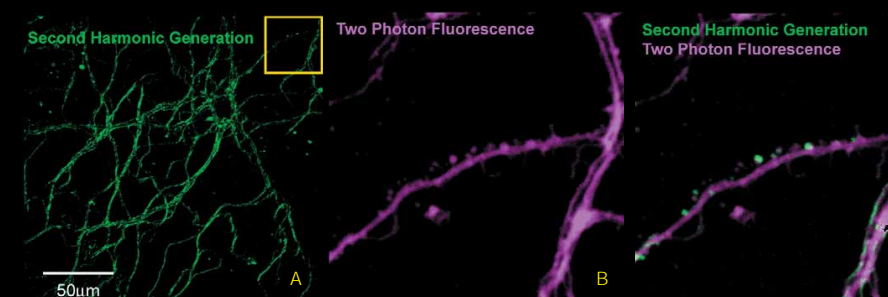
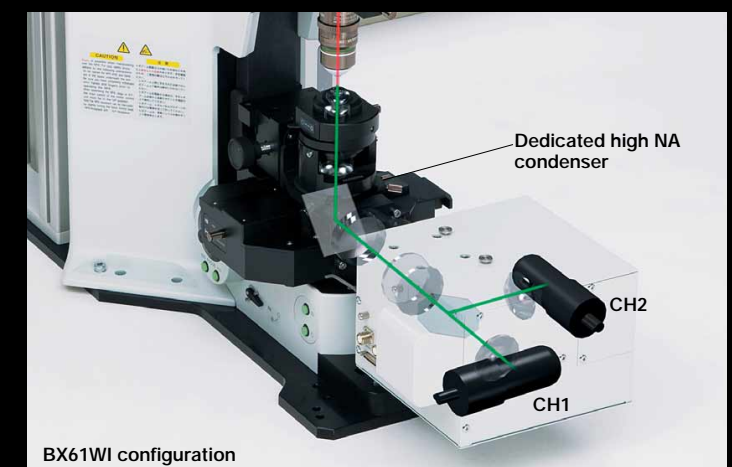
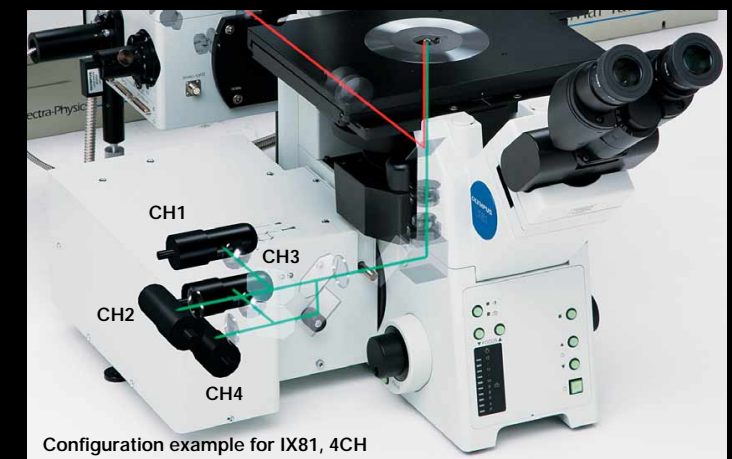
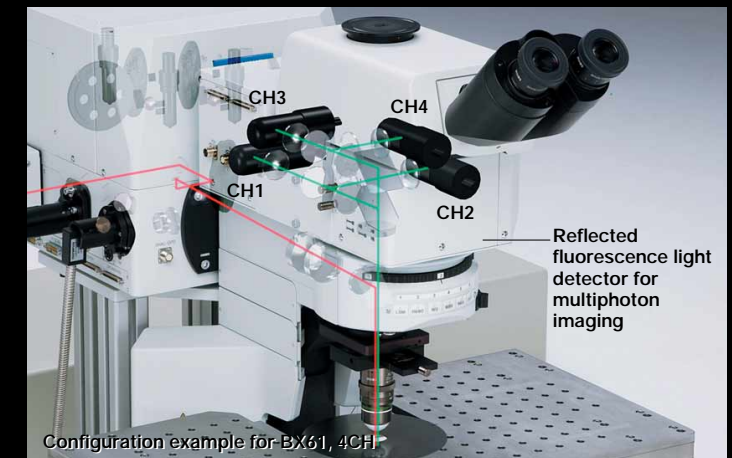

Second Harmonic Generation imaging of neurons.

A: SHG image of neurons in dissociated culture from the mouse cerebral cortex. After FM4-64 was injected to neurons, the cells were irradiated with a femtosecond laser at 950 nm and the SHG signal at 475 nm was detected with the transmitted light detector.

B: Zoomed fragment (5X) of the specimen in the yellow box in image A. As it is apparent, spines protruding from dendrites can be observed with SHG.

C: SHG and multiphoton images have been superimposed.

Image data provided by: Mutsuo Nuriya, PhD, Masato Yasui, MD, PhD Department of Pharmacology School of Medicine, Keio University

# Application of multiphoton microscopy to laser light stimulation.

## Multiphoton simultaneous imaging and laser stimulation.

Laser light stimulation can be adjusted as desired without the user being limited by imaging settings. This is due to the independent FV1000's second scanner (SIM) used for laser light stimulation (available as an option). Connected to SIM-scanner, the second multiphoton laser provides simultaneous stimulation at the same focal plane that is used for imaging.

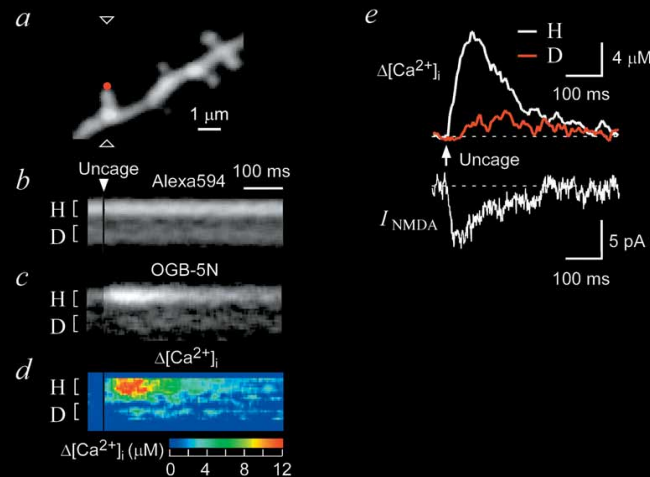

Calcium signal of a single dendritic spine examined by multiphoton uncaging and fluorescence  
 a) Stacked fluorescent image of dendritic spines in the hippocampus (excitation of 830 nm). Whole-cell recording was performed. Alexa 594 and the calcium indicator OGB-5N were injected. At the head of the single spine (red), multiphoton uncaging of caged glutamate was done and glutamate was injected (excitation of 720 nm). A line scan was performed on the line (the line linking the 2 triangles) from the head of this single spine toward the dendritic trunk.  
 b), c) Simultaneous line scanning for Alexa 594 and OGB-5N.  
 d) Calcium concentration determined from the fluorescence emission ratios of OGB-5N and Alexa 594.  
 e) Changes in calcium concentration at the head of the spine (H, black), changes in calcium concentration at the dendritic trunk (D, red), current from whole-cell recorded NMDA receptors (INMDA). Calcium flow into the trunk via NMDA receptors at the head of the spine is apparent from these observations.

Reprinted from Noguchi et al. Neuron 46(2005)609-622.  
 Jun Noguchi, Haruo Kasai  
 Center for Disease Biology and Integrative Medicine, Faculty of Medicine, University of Tokyo

## Laser light mapping and multipoint stimulation.

The observation field is divided into a grid and separate fields are discretely irradiated with a laser, allowing laser light stimulation while excluding the signal influence from adjacent fields. The mapping & multipoint software enables auto stimulation at multiple points (optional software).

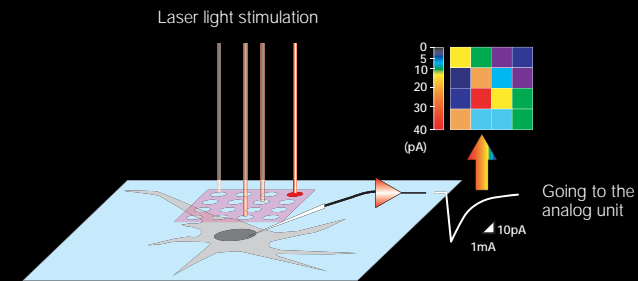

A typical combination of laser light stimulation and an analog unit

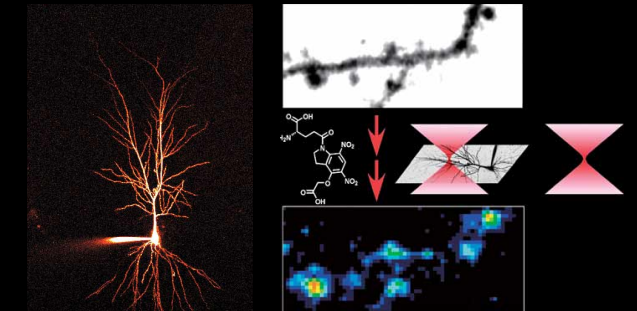

Functional mapping of glutamate receptors at the single spine level via multiphoton excitation of caged glutamate.

Left: Stacked multiphoton fluorescence images (excitation of 830 nm, Alexa594 as fluorochrome) of hippocampal CA1 pyramidal cells.  
 Top right: An enlargement of the mapping field.

Bottom right: Electrical signals from glutamate receptor current, obtained with whole-cell recording. The separate points in the top right figure are irradiated with the laser, captured and then mapped with color-coding to represent the values of cell response. At that point, caged glutamate (CDNI-glutamate) is then injected to specimen slices.

Image data provided by:  
 Masaki Matsuzaki, Haruo Kasai  
 Center for Disease Biology and Integrative Medicine, Faculty of Medicine, University of Tokyo

## Providing both visible light stimulation and multiphoton stimulation.

Multiple point stimulation software (optional) allows continued stimulation switching between IR and visible in one experiment. Example, uncaging with multiphoton excitation follow by channel-rhodopsins visible light stimulation without the need to stop image acquisition.

■ Comparison of stimulation with a visible laser and IR pulsed laser (conceptual drawing)

For example, with the dichromatic mirror indicated below, stimulation can be done with visible light at 488 nm and 559 nm; excitation can then be done with IR light at 920 nm to allow observation.

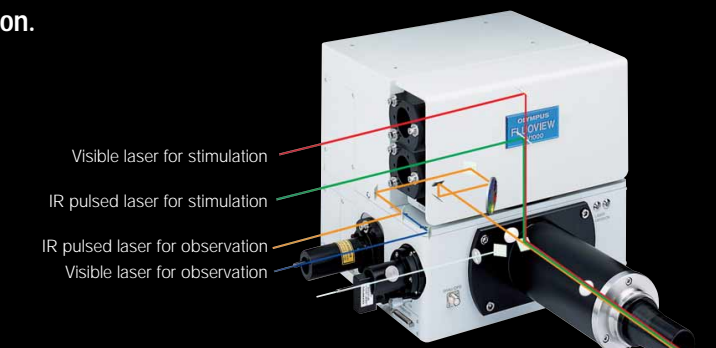
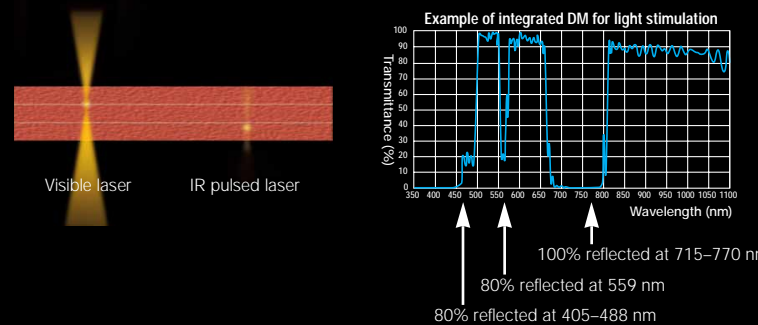

### Wide choice of scan modes.

The FV1000MPE comes with AOM as standard and provides fine position and time control of imaging and light stimulation. Using Olympus' own tornado scanning allows rapid bleaching and laser light stimulation of desired fields in experiments like those involving FRAP and uncaging.

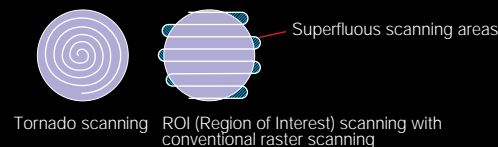

## Synchronization of laser light stimulation and patch clamp signals.

The FV1000MPE's analog unit enables voltages to be converted into images and handled just like fluorescence images. For example, electrical signals measured by patch clamping during laser light stimulation can be synchronized with the image acquisition and displayed with pseudo color.

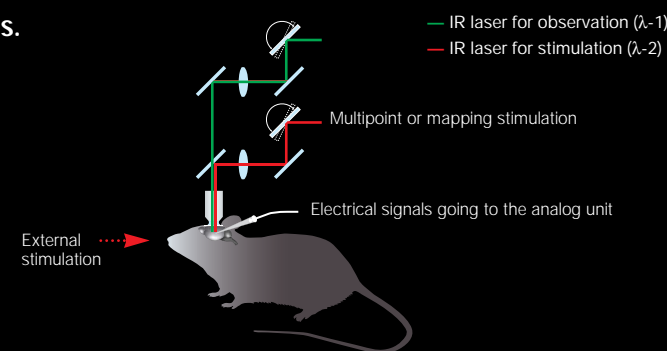

### Multipoint scans.

User can designate the number of points on an image for light stimulation. Stimulation timing, duration and interval can be defined in the magnitude of  $\mu$ s and the user can program the experiment with continuous or pulse stimulation. The same software also provides features that allows extended multiple points surrounding one single point to cover a small area.

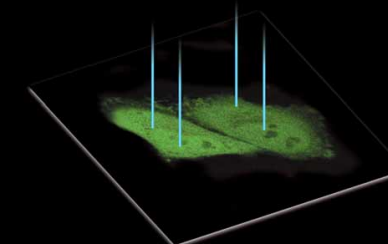
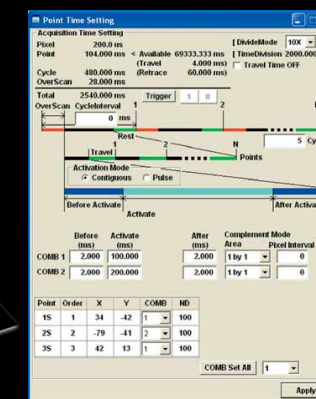

### Mapping scans.

Light stimulation can be applied to a rectangular region of interest. Software control of stimulation of each point assures neighboring points will not be excited. This allows the user to observe reaction of sample more accurately. Changes in intensity from those points can be processed as a mapped image or graph.

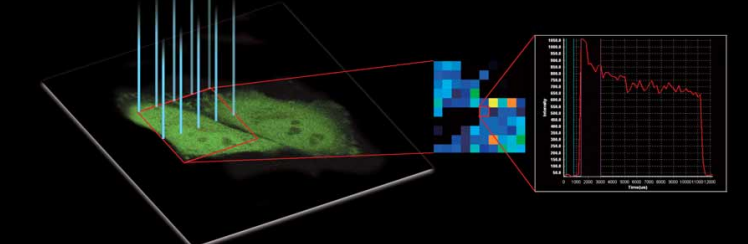

### Brightness compensation function in the Z direction.

The images brightness when imaging deeper into a thick specimen. Use of this function enables changing the detector sensitivity and laser power while continuously acquiring an image to match the focal position, thus allowing high-sensitivity and high-precision imaging without losing information from the thick portion of the specimen.

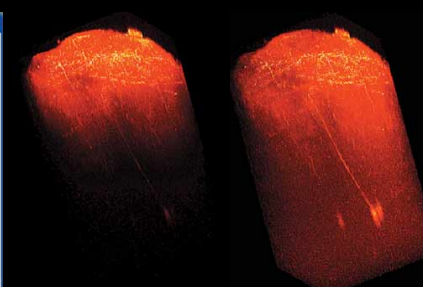
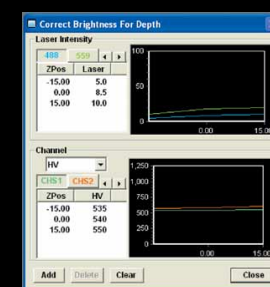

## The arm height raising kit enables small animal experiments

The arm height raising kit provides an additional 40 mm of clearance and is mounted between the microscope frame and the reflected light illuminator. This facilitates experiments requiring small animals.



### Mouse brain

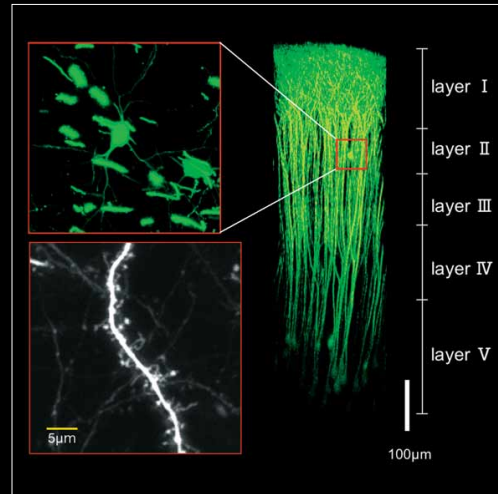

3-dimensionally constructed images of neurons expressing EYFP in the cerebral neocortex of a mouse under anesthesia.

Cross-sectional images down to 0.7 mm from the surface can be observed after attachment of a special adapter to the specimen.

Objective: LUMPlanFL 60XW/IR

Image data provided by:  
Hiroaki Waki, Tomomi Nemoto, and Junichi Nabekura  
National Institute for Physiological Sciences,  
National Institutes of Natural Sciences, Japan

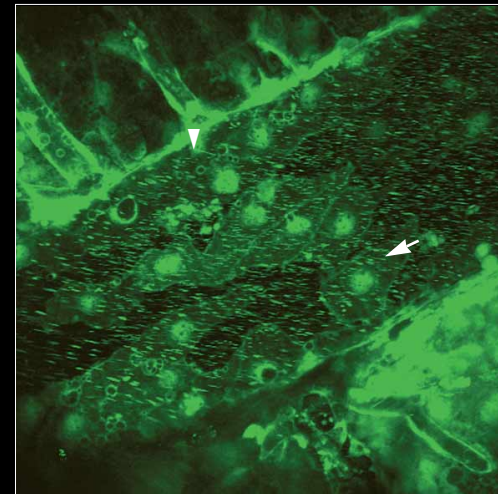

In vivo observation inside the brain of a GFP-actin transgenic mouse.

One hundred and three minutes after a low concentration of lipopolysaccharide was intravenously injected into the mouse, attachments between epithelial cells detached (arrow) and a thrombus formed (triangle).

Image data provided by:  
Hisako Nakajima, Akira Mizoguchi  
Neural regeneration and cell communication, Genomics and regenerative biology,  
Me university graduate school of medicine

### Mouse retina

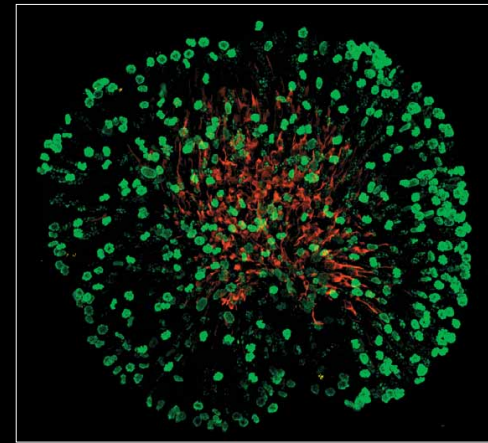

Observation of neurogenesis in the early mouse retina

Whole-mount specimen of the mouse retina in which mitotic progenitor cells are stained with Alexa488 (green) and neurons are stained with Alexa568 (red).

Using this specimen, images were superimposed after about 120 cross sectional images were acquired.

(with XLPLN25XWMP objective and excitation wavelength of 890 nm)

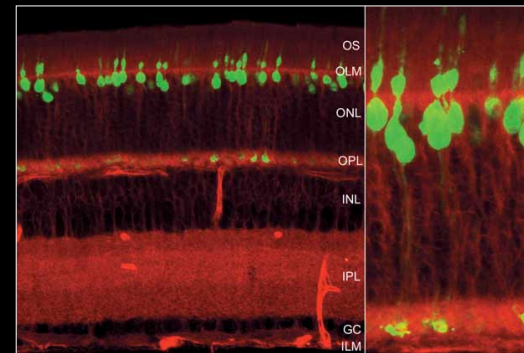

Observation of the retina in which rod photoreceptors were labeled with EGFP (green) and ubiquitous retina cells were labeled with tdTomato (red).

The specimen was fixed for a short period of time, but images were acquired under conditions for live cell imaging (low laser power) (with an XLPLN25XWMP objective and excitation wavelength of 890 nm).

Specimens provided by:  
Dr. Branden R. Nelson, PhD at the University of Washington

### Silkworm

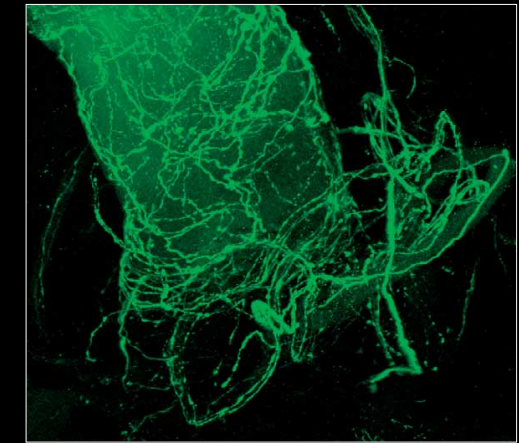

3-dimensionally constructed image of cGMP-containing cells marked with CY3 located along the antenna nerve of the silkworm.

200 μm projection image.

Image data provided by:  
Hitoshi Aonuma, Research Institute for Electronic Science, Hokkaido University, Japan

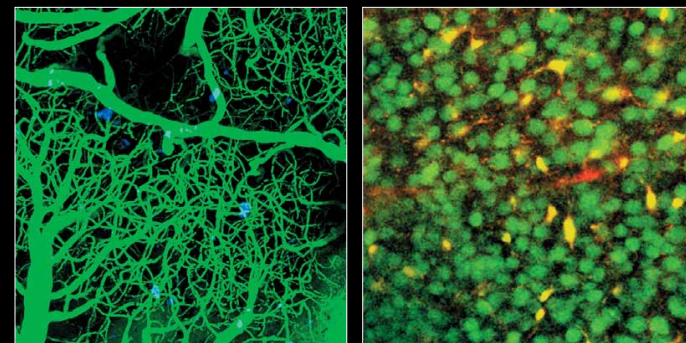

Left: fluorescence angiogram in the brain of a living mouse represented by a maximum intensity projection of the imaging volume of ~600X600X600 microns. The imaging was performed on a transgenic mouse that develops senile plaques similar to those found in case of Alzheimer's disease. They are labeled with the fluorescent compound methoxy-XO4 (blue).

Right: a group of neurons and astrocytes loaded with the intracellular calcium reporter OGB-1 (green). Astrocytes are labeled with SR101 (red). Astrocytes that are loaded with OGB and tagged with SR101 are yellow.

Image data provided by:  
Brian J. Bacskai, PhD  
Alzheimer's Disease Research Unit, Mass. General Hospital

### Rat brain

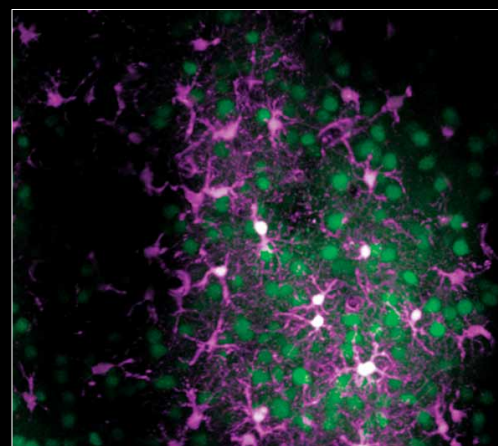

Z-stack image of neurons and glial cells in layers II and III of the cerebral cortex of a rat under anesthesia.

Magenta: glial cells (astrocytes) marked by specific fluorescence marker Sulforhodamine 101, Green: neurons and glial cells, Ca-sensitive fluorescent dye Oregon Green 488 BAPTA-1 200 μm.

Image data provided by:  
Norio Takata, Hajime Hirase  
Neuronal Circuit Mechanisms Research Group, Riken Brain Science Institute, Japan

### Mouse spleen

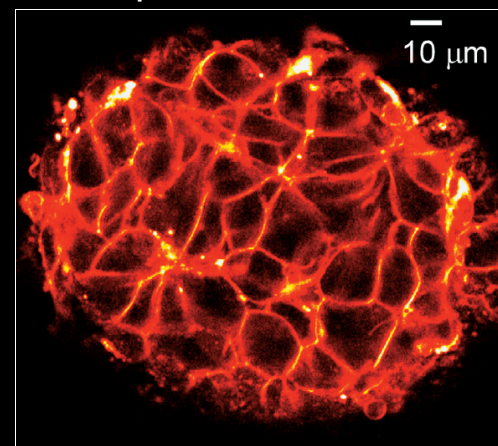

Living pancreatic islet of Langerhans stained with FM1-43 lipid-soluble fluorescent dye. The cell membrane structure of the islet of Langerhans and growth of the membrane area accompanying insulin exocytosis of a single insulin granule can be observed.

Image data provided by:  
Noriko Takahashi, Haruo Kasai  
Center for Disease Biology and Integrative Medicine, Faculty of Medicine,  
University of Tokyo

### Zebrafish



Transgenic zebrafish with cell membranes labeled with CFP. CFP is shown in green and YFP in magenta.

Image data provided by:  
Dr. Rachel O Wong, Mr. Philip Williams,  
Dept. Biological Structure, University of Washington

Fluorochrome	Excitation wavelength (nm)						
	700	750	800	850	900	950	1000
BFP							
CFP							
EGFP							
EYFP							
Sapphire							
DsRed							
Calcein-Blue							
Calcein-Green							
Ca-Green 5N							
Ca-Orange							
Ca-Crimson							
Fluo-3, Fluo-4							
Indo-1 (when Ca-bound)							
Indo-1 (Ca-free)							
Fura (when Ca-bound)							
Fura (Ca-free)							
Caged Ca							
Mag-Fura							
Cascade-Blue							
Coumarin AMCA							
DAPI							
Hoechst							
Bodipy-FL							
FITC							
RH-795							
Rhodamine							
Dil							
DiD							
Lucifer-Yellow							
AlexaFluor488							
AlexaFluor594							
(Uncaging wavelength) Caged glutamate							
(Uncaging wavelength) Caged Ca							
(Laser light stimulation wavelength) Kikme							

#### References

- Xu, C. and W. W. Webb, J. Opt. Soc. Am. B 13 (3), 481-491, 1996.
- Xu, C., W. Zipfel, J.B. Shear, R.M. Williams and W.W. Webb, PNAS 93(20), 10763-10768, 1996
- Xu, C., R.M. Williams, W.R. Zipfel and W.W. Webb, Biomedicine 4(3), 198-207, 1996
- Heikal, A.A., S.T. Hess, G.S. Baird, R.Y. Tsien and W.W. Webb, PNAS 97(22), 11996-12001, 2000

# A varied lineup for laser light stimulation and in-depth observation, from *in vivo* to Live Cell imaging.

## M system (multiphoton exclusive system)

### M scanner multiphoton exclusive system

This multiphoton exclusive system is not equipped with visible light lasers. Simple optics optimized for multiphoton microscopy allow a smaller size, simpler operation, and deeper imaging within the specimen. The system uses a gold-coated galvanometer scanning mirror.

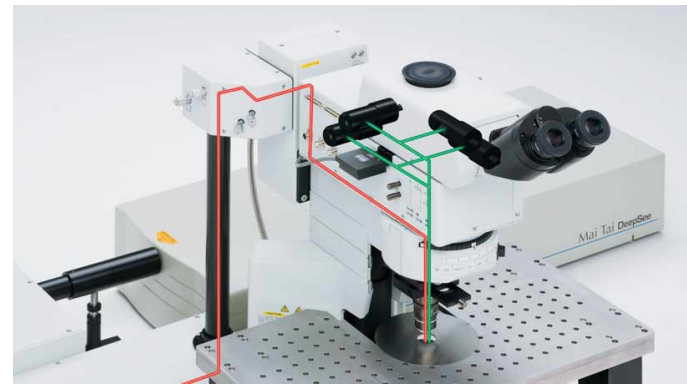

Red: IR pulsed laser, Green: Fluorescent light

## B system (basic system)

### Standard scanner multiphoton microscopy system

This system is equipped with an IR laser for multiphoton imaging and laser for visible light, so it is designed for deep imaging by multiphoton microscopy and confocal imaging with a visible laser. The system is designed for a variety of imaging including Live Cell and *in vivo* imaging.

\* Using this system along with the double laser combiner allows multiphoton imaging and visible light stimulation.



Red: IR pulsed laser, Blue: Visible light laser, Green: Fluorescent light

## S system (stimulation system)

### Multiphoton laser light stimulation system

This system is equipped with an IR laser delivering the light to the scanner for stimulation. In addition to general multiphoton microscopy, the system allows pinpoint light stimulation by multiphoton excitation during imaging with a visible laser.

\* Multiphoton microscopy does not allow some image acquisition modes such as Time Controller.



Red: IR pulsed laser (for stimulation/observation), Blue: Visible light laser, Green: Fluorescent light

## T system (twin system)

### Multiphoton imaging plus multiphoton laser light stimulation system

This system synchronizes laser light from 2 independent IR lasers for stimulation and imaging. It provides the multiphoton imaging capability of visualizing deep within the tissue, while at the same time, enabling pinpoint 3D stimulation with multiphoton excitation. eg. stimulate a single dendritic spine located deep within the tissue. The newly introduced SIM dual port feature allows the SIM scanner to accurately stimulate with both visible laser as well as IR laser.

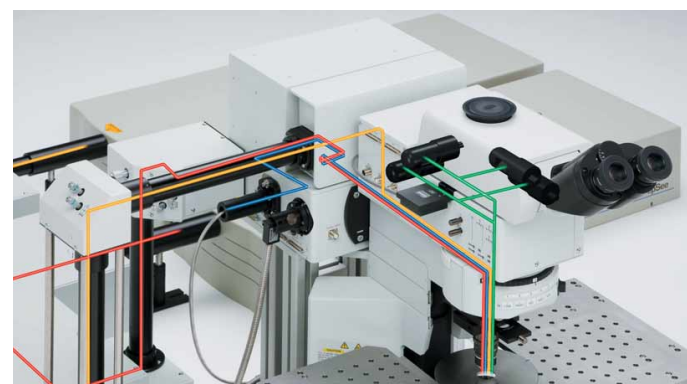

Red: IR pulsed laser (for observation), Yellow: IR pulsed laser (for stimulation), Blue: Visible light laser, Green: Fluorescent light

Multiphoton microscopy	Visible laser light microscopy	Visible laser light stimulation	Multiphoton laser light stimulation	Transmitted light fluorescence microscopy using multiphoton	Transmitted light DIC microscopy (visible light)
Optional	Optional	Optional	Optional	Optional	Optional

## Laser sharing system

This system allows 2 microscopes to share a single laser.

**Example of a B system (Basic system) sharing a laser with an M system (Multiphoton exclusive system)**

Both the B system's BX61WI and M system's BX61WI share a single laser.

**Example of a T system (Twin system) sharing lasers with a B system (Basic system)**

The BX61WI in the B system and IX81 in the T system share 2 lasers.

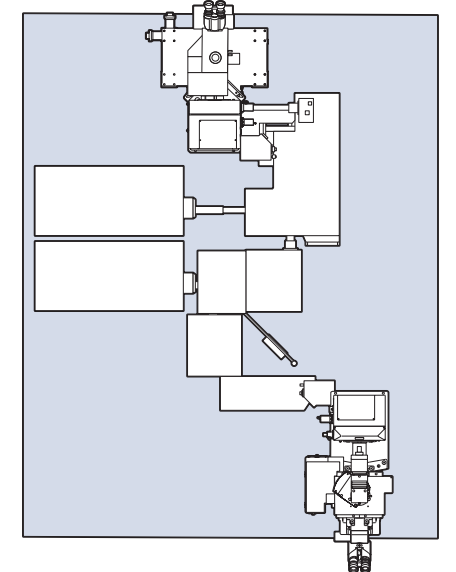
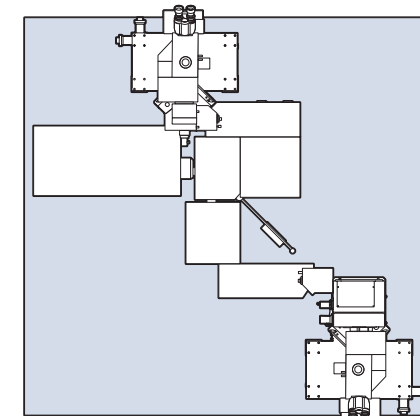

Recommended system combinations  
 BXM-BXB system (BX61WI-M & BX61WI-B)  
 IXB-BXB system (IX81-B & BX61WI-B)  
 BXT-BXB system (BX61WI-T & BX61WI-B)  
 BXT-IXB system (BX61WI-T & IX81-B)

### Optics adapted following lasers

Both the MaiTai BB/HP/eHP DeepSee-OL lasers (from Spectra Physics, a division of Newport Corporation) and Chameleon Vision I/II-OL lasers (from Coherent, Inc.) are designed exclusively for the FV1000MPE, to provide optimal multiphoton performance.

Manufacturer	Model	Wavelength covered
Spectra-Physics	MaiTai BB DeepSee-OL	710 nm — 990 nm
	MaiTai HP DeepSee-OL	690 nm — 1040 nm
	MaiTai eHP DeepSee-OL	690 nm — 1040 nm
COHERENT	Chameleon Vision I-OL	690 nm — 1040 nm
	Chameleon Vision II-OL	680 nm — 1080 nm



### Lasers used along with visible laser light imaging

The multi-combiner enables combinations with all of the following diode lasers: 405 nm, 440 nm, 473 nm, 559 nm and 635 nm. The system can also be equipped with conventional Multi-line Ar laser and HeNe-G laser.



**Double type**  
 The multi-combiner outputs laser light with two fibers. Light can be used for both observation and laser light stimulation.



**Single type**  
 Single channel laser for visible light observation. AOTF is standard equipment.

System layout examples

**M system (multiphoton exclusive system)**

Multiphoton exclusive system, BX61/IX81 configuration

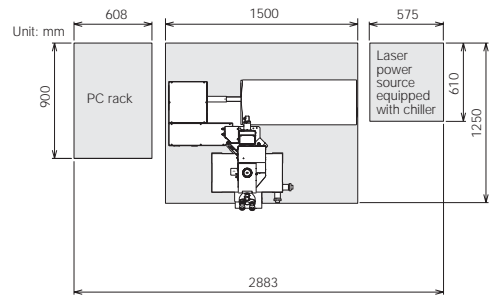

**B system (basic system)**

Basic system, BX61/IX81 configuration

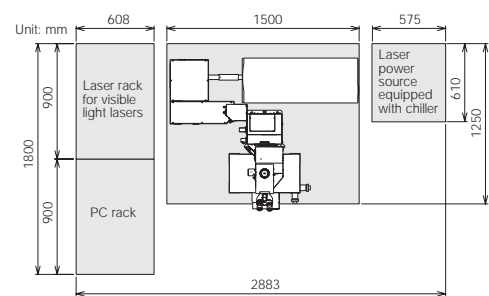

**S system (stimulation system)**

Stimulation system, BX61/IX81 configuration

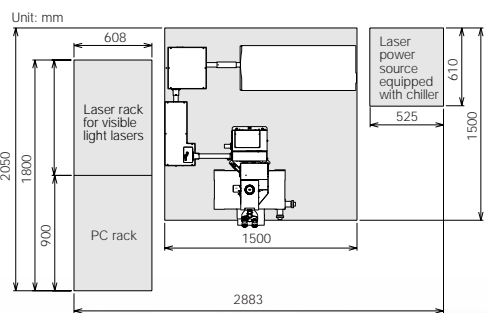

**T system (twin system)**

Twin system, BX61/IX81 configuration

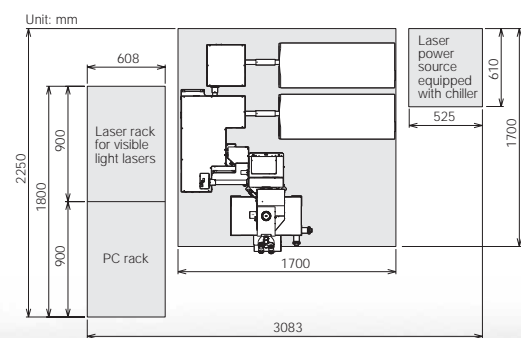

B system  
Basic system IX81 configuration

B system  
Basic system BX61WI configuration

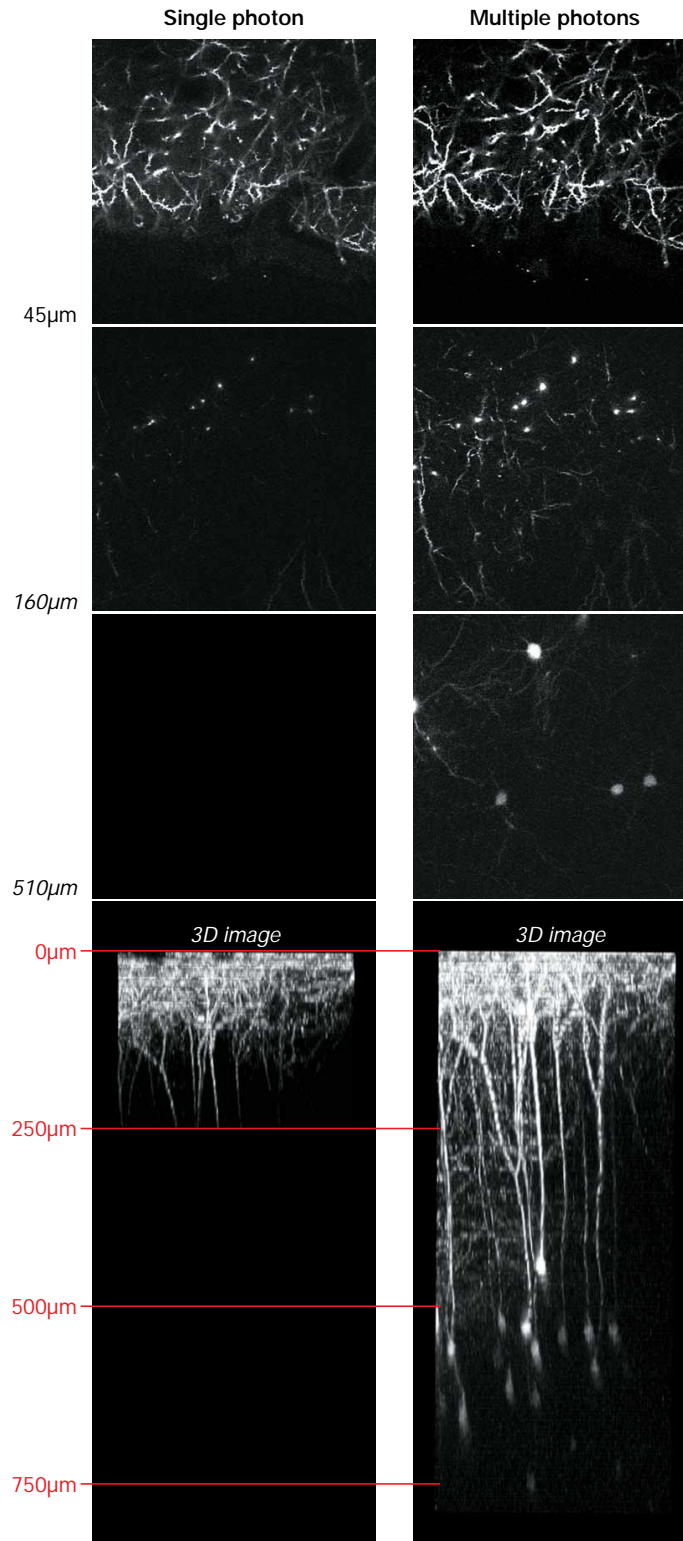

The cerebral cortex of M-line, a strain of transgenic mouse (GFP), was exposed and *in vivo* Z-stack imaging was performed with excitation at 488 nm for single photon excitation and with excitation at 920 nm for multiple photons. With single photon, depths to only 250 µm can be observed, but with multiple photons depths to about 750 µm can be observed.

Images were acquired at a Live cell imaging seminar (National Institute of Advanced Industrial Science and Technology, Tsukuba Research Center).

Specimens provided by:  
Kimihiro Kameyama, Tomoyo Ochiishi, Kazuyuki Kiyosue, Tatsuhiro Ebihara  
Molecular Neurobiology Group, Neuroscience Research Institute,  
National Institute of Advanced Industrial Science and Technology, Japan

Multiphoton principle

**Multiphoton excitation**

A laser radiates high-density light at wavelengths up to several times longer than the emission wavelength, exciting the fluorescence of molecules located exactly at the focal point only. Confocal-type optical sectioning can be achieved without the use of a pinhole, since light is not emitted from areas outside the focal plane.

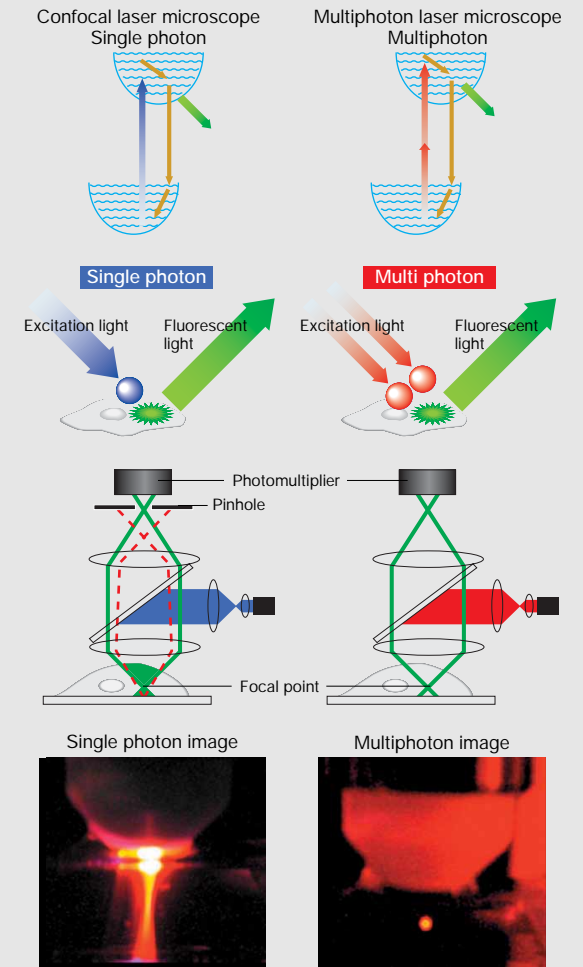

Tomomi Nemoto  
National Institute for Physiological Sciences,  
National Institutes of Natural Sciences, Japan  
Haruo Kasai  
Center for Disease Biology and Integrative Medicine,  
Faculty of Medicine, University of Tokyo, Japan

**What is Second Harmonic Generation (SHG)?**

SHG is a secondary nonlinear optical phenomenon. In SHG, the energy of 2 photons entering a specimen is combined, producing energy in the form of light. That is, the wavelength of light observed is half of the incident wavelength (the frequency is doubled). An SHG signal is not produced unless molecules in the material are noncentrosymmetric (i.e. a center of inversion symmetry is absent). The signal is linear, so a transmitted light detector is needed. In addition, SHG signal intensity is proportional to the size of the potential, so changes in membrane potential in the vicinity of lipid bilayers of cells with a regular molecular structure can also be analyzed.

