

INDUSTRIAL

Powerful Analysis, Dynamic Imaging

DSX1000 Digital Microscope



EVIDENT

Intelligent Innovation

Fast failure analysis with guaranteed accuracy and repeatability*



*To guarantee XY accuracy, the calibration must be performed by an Evident service technician.

Macro to Micro Versatility

- ▶ Large selection of lenses to find the best magnification, resolution, and working distance for your sample
- ▶ Coded free-angle observation system



3 - 8



Multiple Observations with a Single Click

- ▶ Change the lenses and observation method quickly by pushing a button
- ▶ All observation methods are available at all magnifications

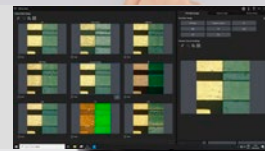

9 - 14



Be Confident in Your Results with Guaranteed Accuracy and Precision

- ▶ Accurate measurements with a telecentric optical system
- ▶ Both accuracy and repeatability are guaranteed at all magnifications



15 - 18



Advanced Measurements Are Fast and Easy to Obtain

- ▶ Improved analysis functions make the DSX1000 microscope a powerful and versatile inspection tool
- ▶ Faster analyses with advanced, easy-to-use functions



23 - 28

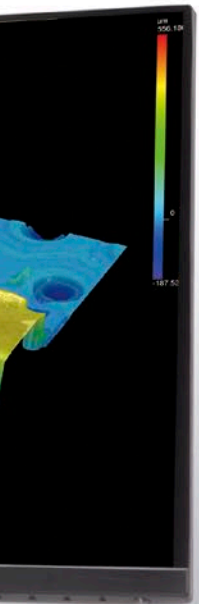

Macro to Micro Versatility

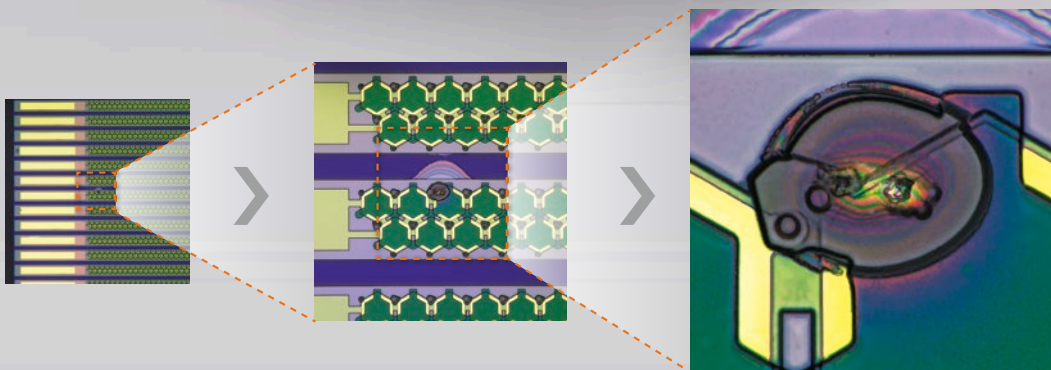
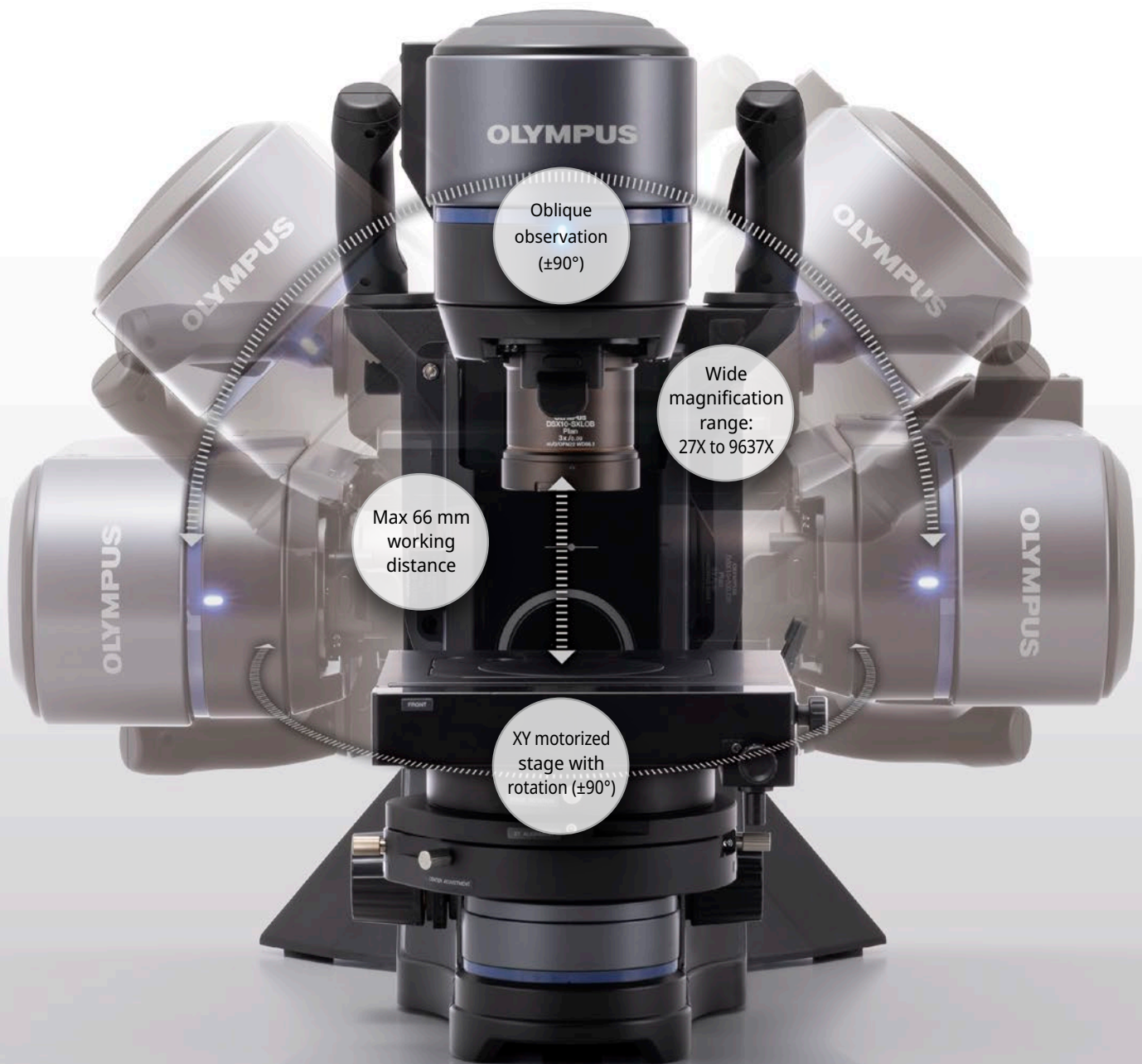

The microscope's 27X to 9637X magnification range enables you to conduct high-level, low-magnification overview observations and seamlessly zoom down to the micron level for detailed analysis. The depth of field and a long working distance give you the flexibility to inspect larger samples, while the free-angle observation system enables you to image your sample from many directions.

Solving Inspection Challenges

Rough Inspection and Micron-Level Analysis with One System

In the past, both high-magnification and low-magnification microscopes were needed to complete an inspection. Switching your samples between microscopes took time and required many setting adjustments.



- Better objectives deliver better resolution
- Long working distance
- Deep depth of focus
- Quick and easy lens replacement

DSX1000

Complete your inspection with one easy-to-use system.

High-Resolution Images at High Magnification

When inspecting uneven samples, it is important to maintain a safe distance between the lens and sample to keep from damaging it. To see details, you need to increase the magnification, but this typically results in worse resolution.

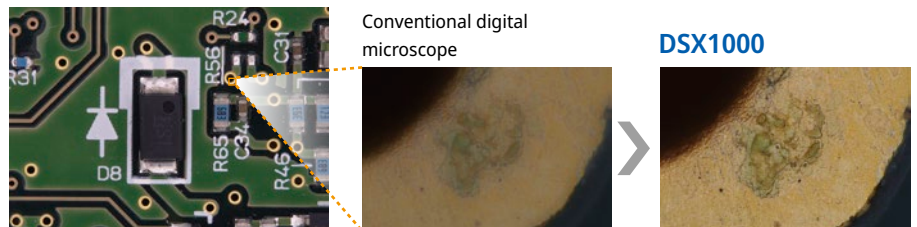

DSX1000

High-quality images at high magnification with advanced optics.

Minimize the Chance of Crashing into Your Sample

If the distance between your sample and the lens is too small, the objective can crash into the sample during analysis, potentially damaging it.



DSX1000

Observe uneven samples without bumping into them.

Choose the Best Lens for Your Analysis

Our lineup of 17 objective lenses, including super long working distance and high numerical aperture options, provides the flexibility to obtain a wide range of images.



For more information on our lenses, see pages 35 and 36.

See the Whole Picture: 27X to 9637X Magnification Range

Seamlessly change magnification from high-level analysis to detailed observation by pushing a button.

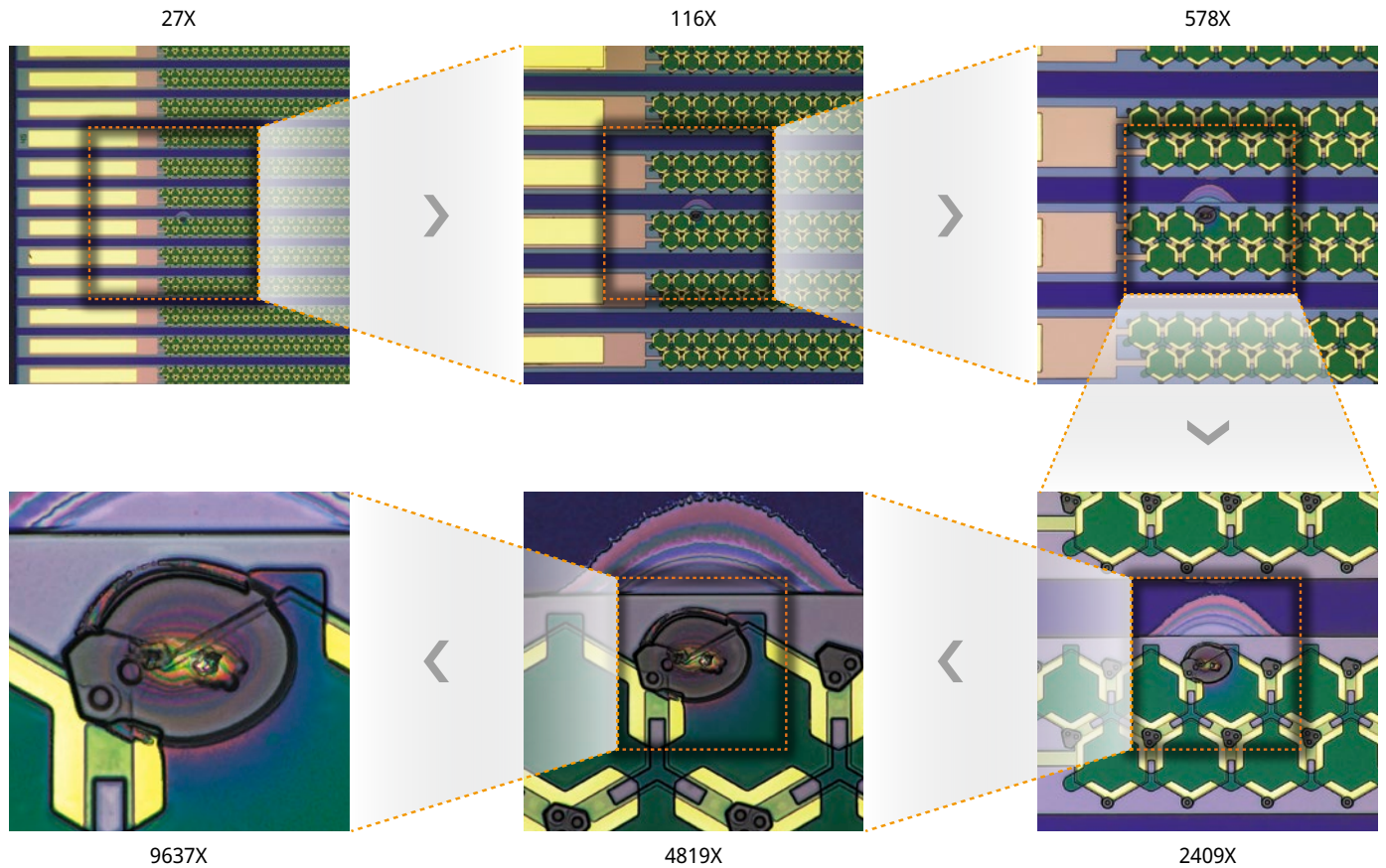

Minimize the Chance of Crashing into Your Sample

The DSX1000 system offers a wide depth of field and a long working distance, so you can observe uneven samples with less chance of causing damage.



SXLOB series

High Resolution and a Long Working Distance in One Objective

Objectives combining high resolution and a long working distance enable you to analyze large, uneven samples, such as automobile and machines parts, that were difficult to inspect in the past using an optical microscope.



XLOB series

Exceptional Resolution with a 0.95 Numerical Aperture

The DSX1000 digital microscope enjoys the full benefits of optical microscope lenses. Their chromatic aberration correction enables you to see the fine details in your sample.



UIS2 series

See Your Sample from Many Angles

Oblique observation ($\pm 90^\circ$)

The eucentric optical design maintains a good visual field when tilted or when the stage is rotated, enabling you to observe your sample from many angles. This flexibility frees you from only having the option to observe your samples directly from above, helping you spot hard-to-see defects.

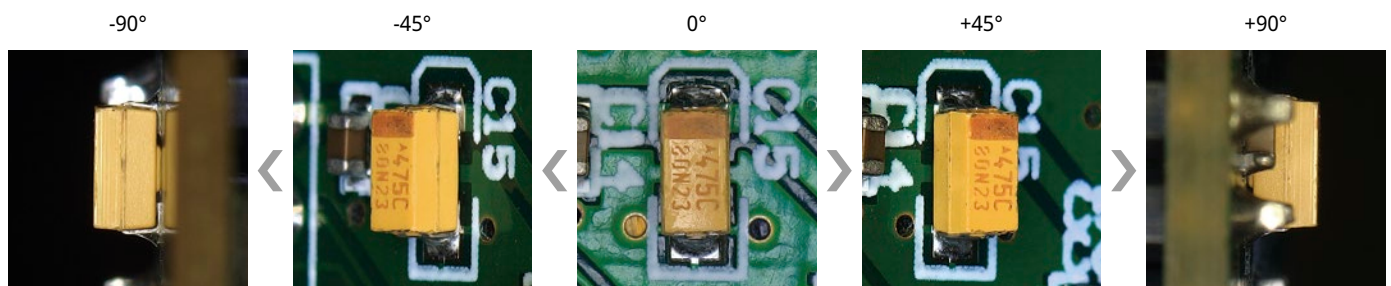

Rotational observation ($\pm 90^\circ$)

The stage rotates 90 degrees for even more flexibility in how you view your sample.

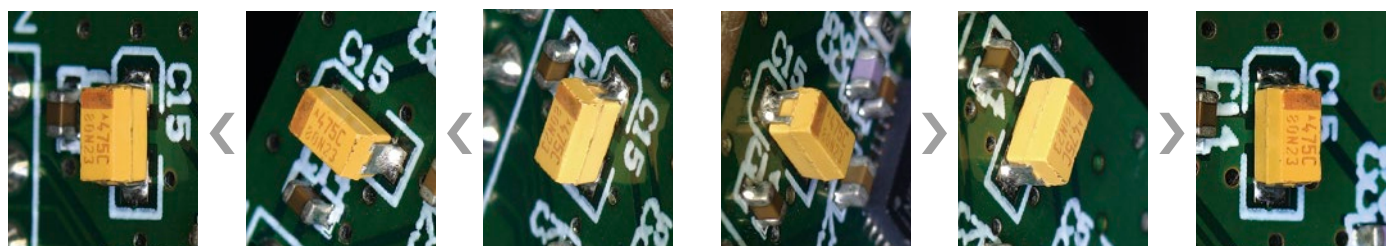
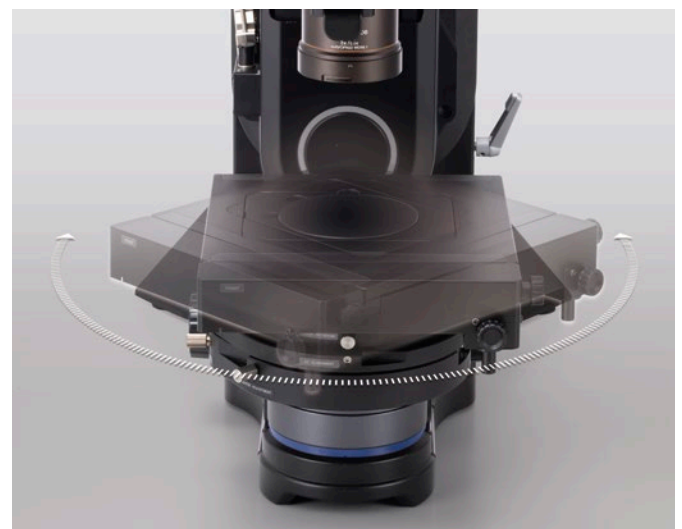

Images You Can Rely On

High-Resolution Live Images

Capture high-quality sample images thanks to the microscope's advanced image sensor technology. The camera's global shutter exposes the entire pixel at the same time to produce smooth live images, even when you are moving the stage. The result is images that can be acquired quickly and easily.

Smooth Live Imaging with a Fast 60 fps Frame Rate

The DSX1000 microscope's fast 60 frames-per-second (fps) frame rate captures sharp images of moving samples.

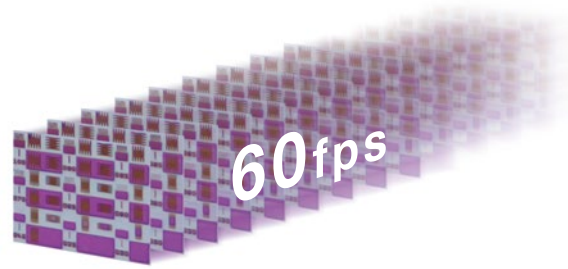

High-Resolution Imaging for High Color Reproduction

You can obtain high-resolution images with exceptional color reproduction and a small file size with the camera's built-in 3CMOS mode.

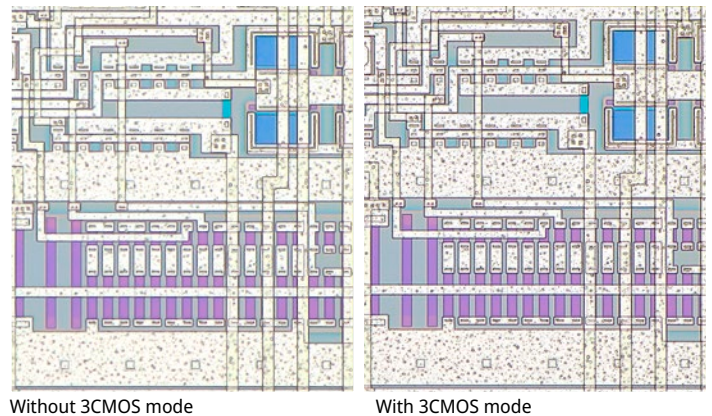
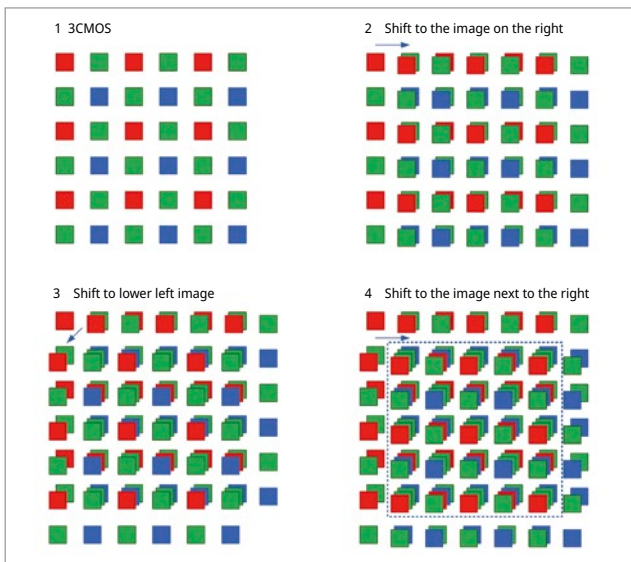

The DSX1000 system can achieve the same image quality as a three-plate camera by capturing images successively after shifting the sensor's position.

Eight-Axis Color Correction

Colored areas are divided into eight axes, and the color within each part is adjusted independently. This gives you the flexibility to strengthen the redness or tune the green to a deeper color. This color adjustment algorithm provides good color reproduction.

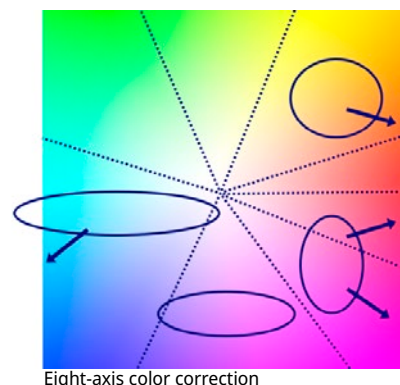
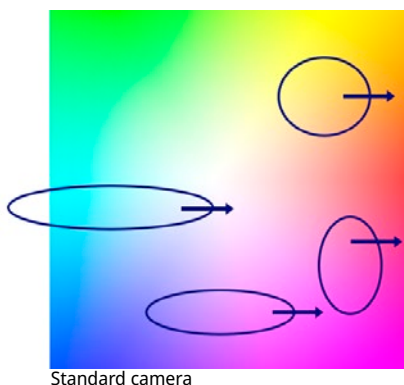

See Your Samples in New Ways

Minimize Glare

The adapter diffuses lighting to help eliminate glare and darken slopes on samples like a cylindrical metal surface.

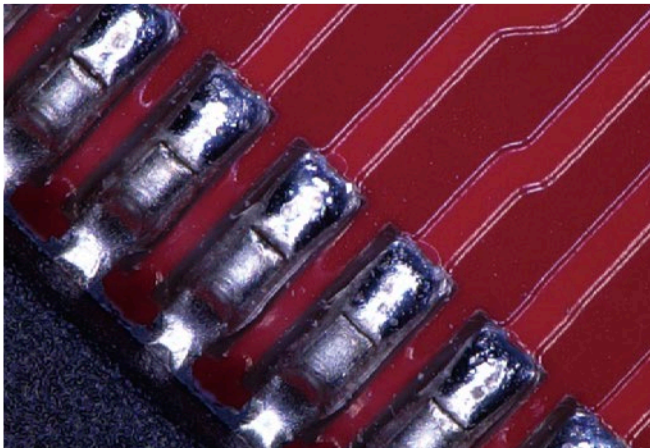

Without adapter

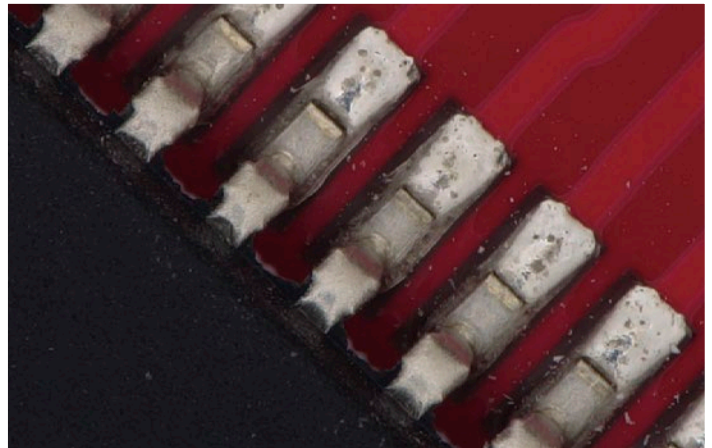

With adapter

Eliminate Reflections

When observing a film's surface or an object through a transparent medium, such as glass, part of the surface can look very bright. An optical polarization plate is used with the adapter to eliminate glare.

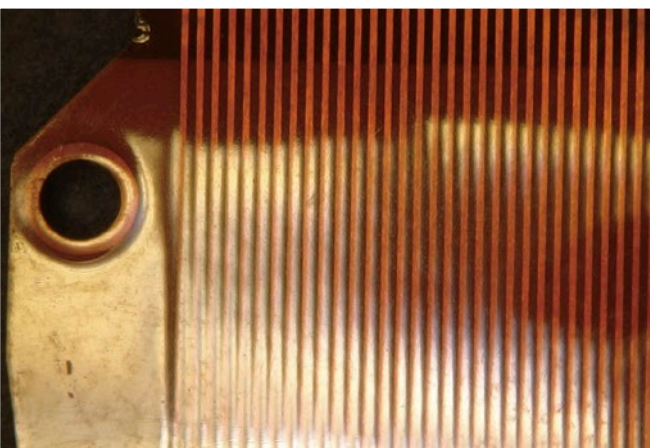

Without adapter

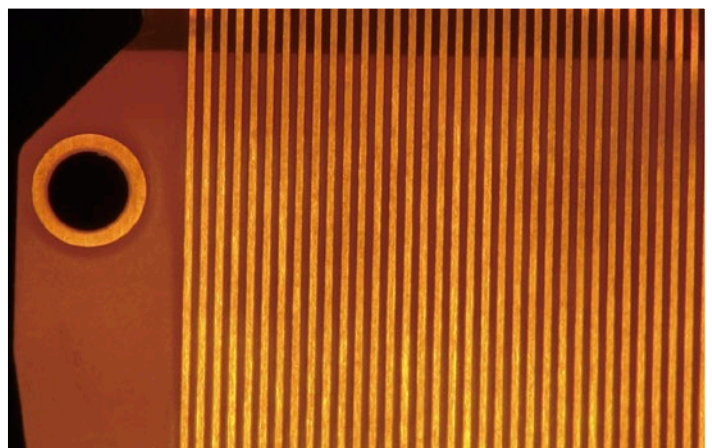

With adapter

One Click Shows the Sample in 3D

Quickly acquire a range of 3D images that cannot be captured using a conventional optical microscope. Even if the sample has large irregularities and part of the surface is out of focus, you can acquire a fully-focused 3D image with the push of a button.

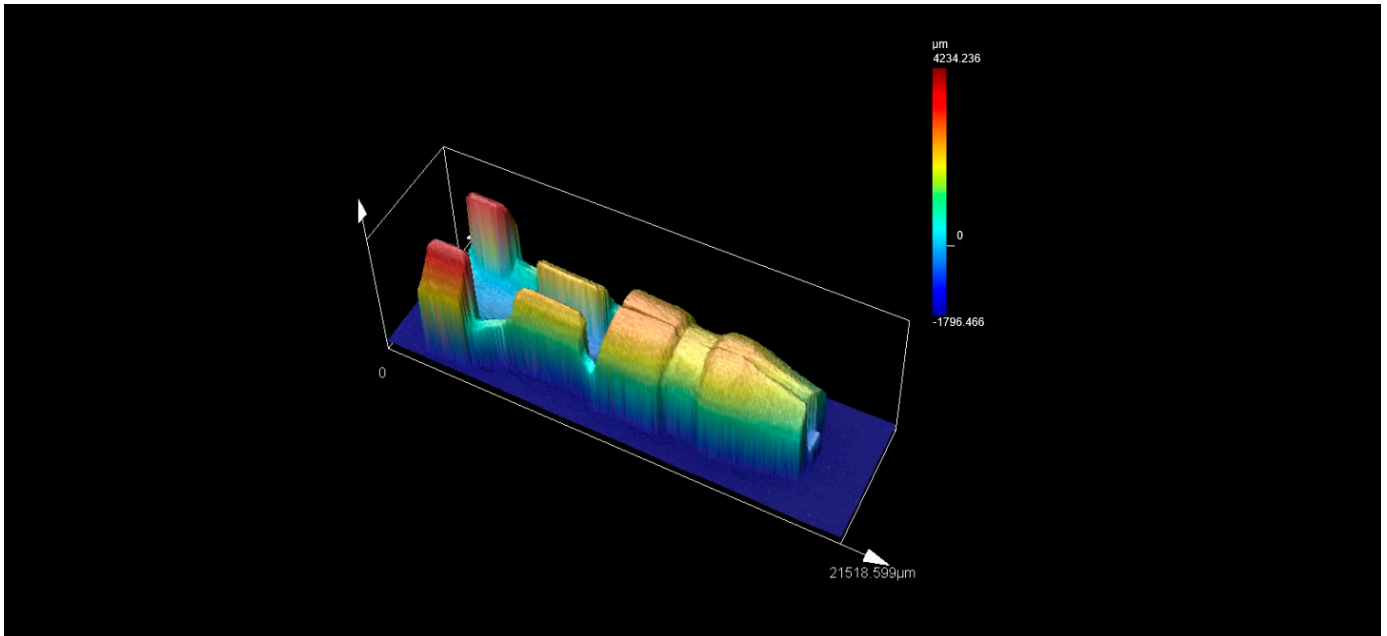

Quickly Acquire 2D/3D Images with Automatic Stitching

Capture 2D/3D images over a wide area with a panorama view. You can stitch together a series of in-focus images to see your sample beyond the microscope's field of view. Using the advanced image stitching features, you can acquire images of any size—the only limit is the available memory on your PC.

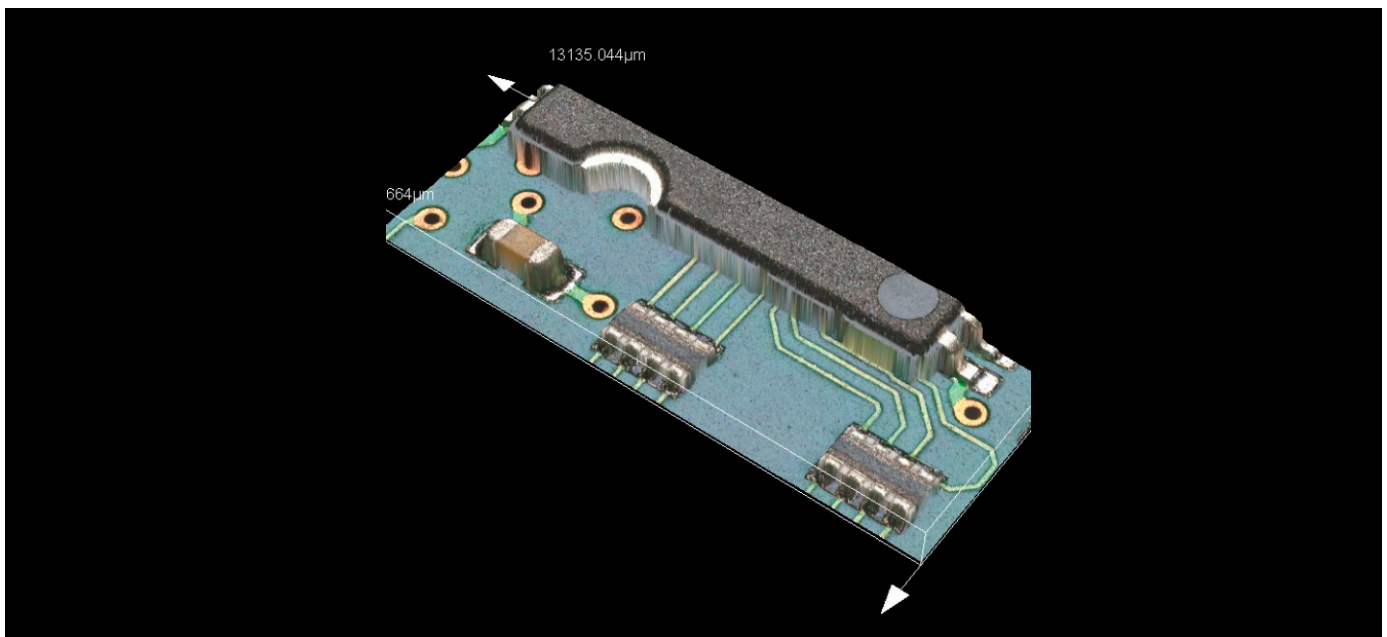

Observe materials over time

Time-lapse imaging automatically records images at preset intervals so that you can observe material changes over time.

Multiple Observations with a Single Click

Console



The DSX1000 microscope offers flexibility to make your inspection workflow faster and easier. Changing observation is as simple as turning a dial, while switching between six observation methods requires only the push of a button.

Best Image Observation

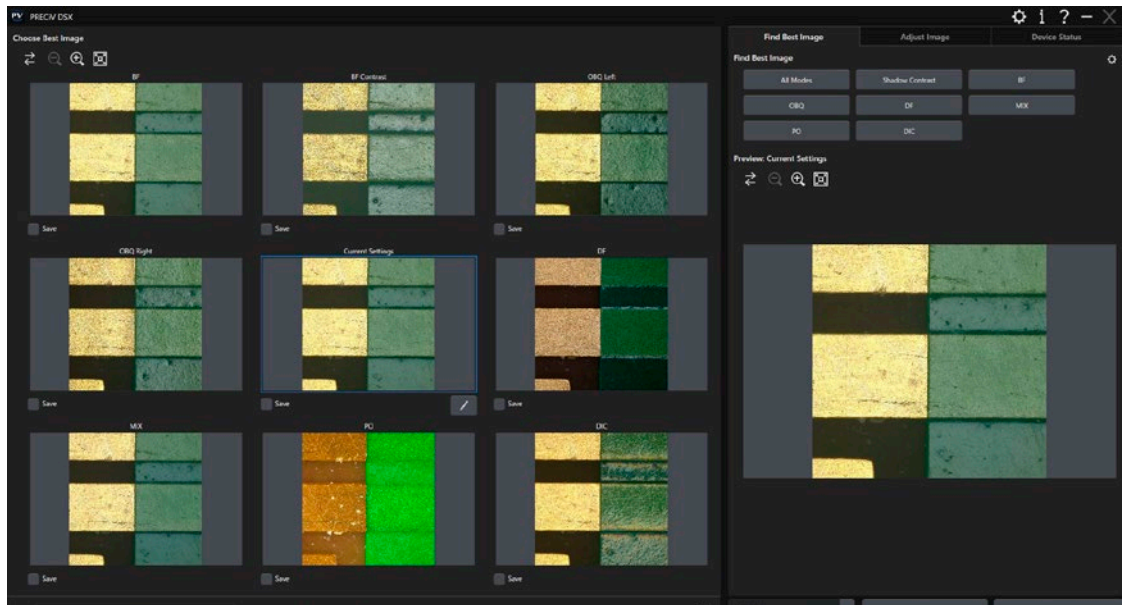

The best image function shows your sample under multiple observation methods, making it easier to detect defective parts.

Sliding Nosepiece



Instant Switching Saves Time

Replacing lenses on an optical microscope can be cumbersome, and some illumination methods may not be supported. On the DSX1000 microscope, changing lenses is quick and easy—choose from six observation methods and switch between them with a single click.

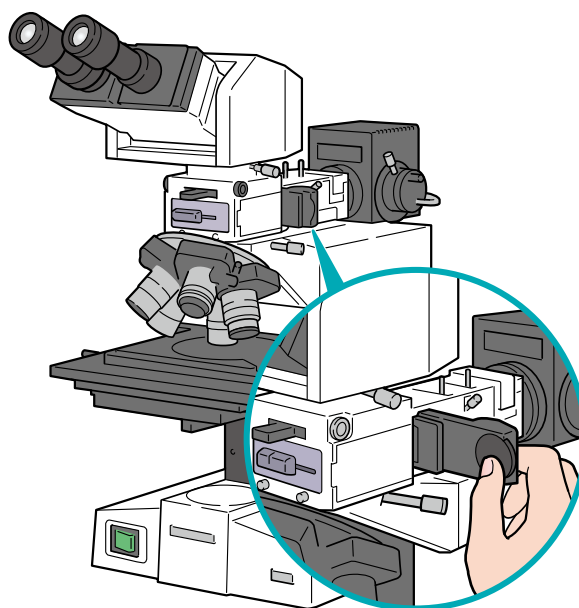

Conventional systems may only offer one or two observation methods, limiting what you can see in your sample. The DSX1000 microscope offers six observation methods so from which you can choose the one that works best for your application.

Supported Observation Methods for Conventional Digital Microscopes

	Observation method A	Observation method B	Observation method C
Lens magnification A	Unsupported	Unsupported	Supported
Lens magnification B	Unsupported	Unsupported	Supported
Lens magnification C	Supported	Conditionally supported	Conditionally supported

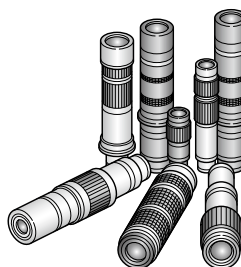

DSX1000

Quickly switch the lens attachment, and the magnification automatically updates. Choose from six observation methods, and switch between them with a single click.

Conveniently Access Common Functions

The multifunctional console makes analysis fast and easy. By grouping the observation and image capture functions on the console, you can easily access these functions without a mouse. Using the console helps you complete your analyses faster while reducing oversights and mistakes.

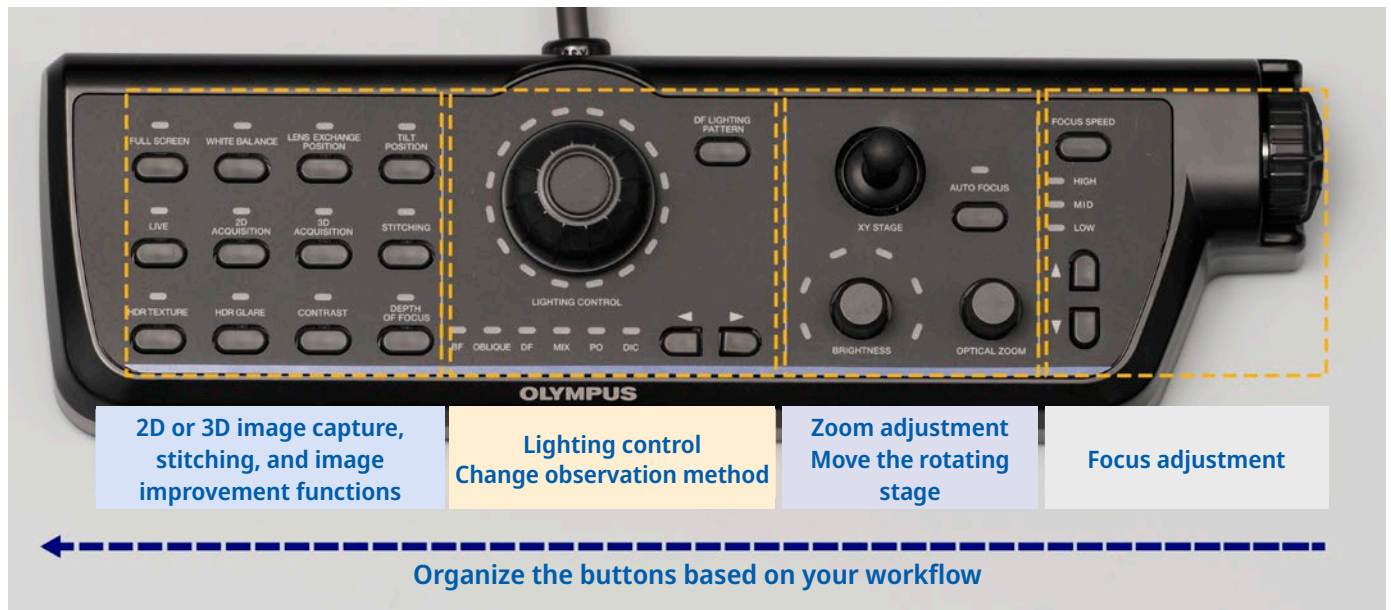

Instantly Change Observation Methods

Conventional digital microscopes have restrictions on which illumination method can be used with each lens. With the DSX1000 digital microscope, you can switch between six observation methods simply by pushing a button on the console.

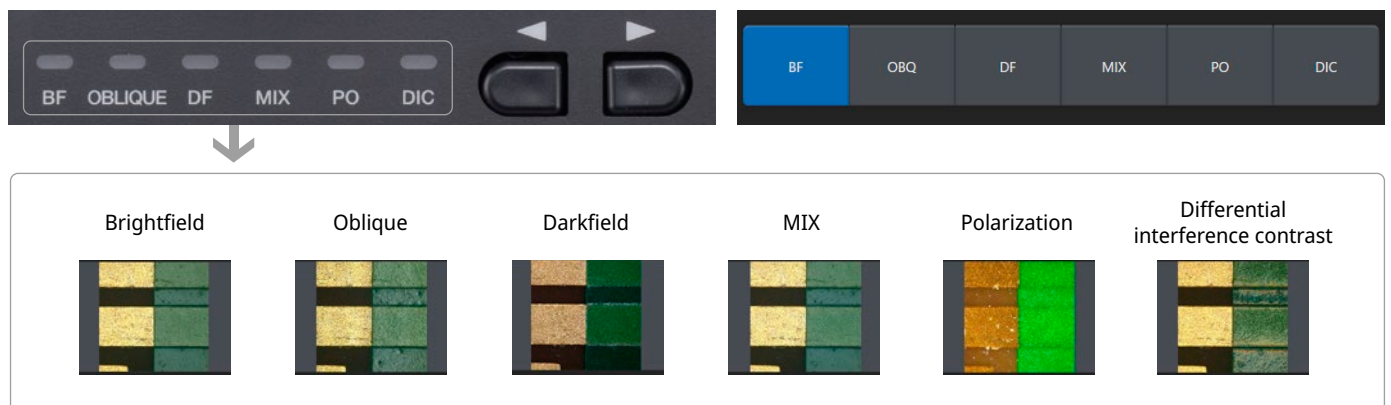

Fast Optical Adjustments Using the Lighting Control Knob

Rather than making adjustments using a mouse, the DSX1000 microscope's lighting control knob makes it simple to fine tune the illumination by rotating the dial.

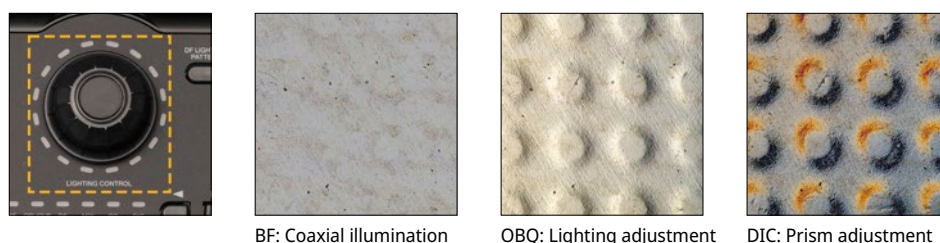

Best Image Observation from Six Observation Methods

Instantly display sample images captured with six different observation methods by a single click. Choose the image that works best for your sample, and the settings will automatically be configured to make the best image from that observation method.

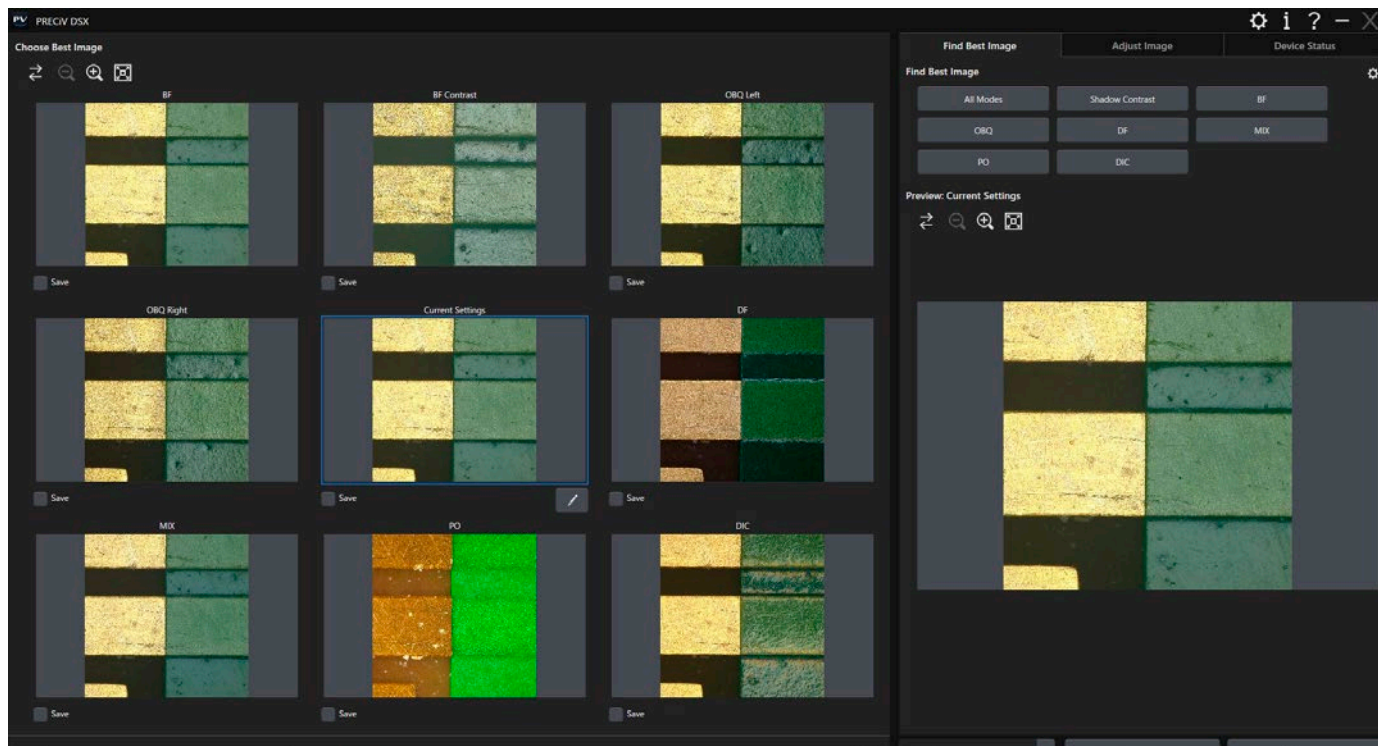

Retrieve Previously Used Observation Conditions

When you capture an image, the system records the conditions under which it was captured. You can recall these conditions by clicking on the image, making it easy to observe your samples using the same conditions and settings.

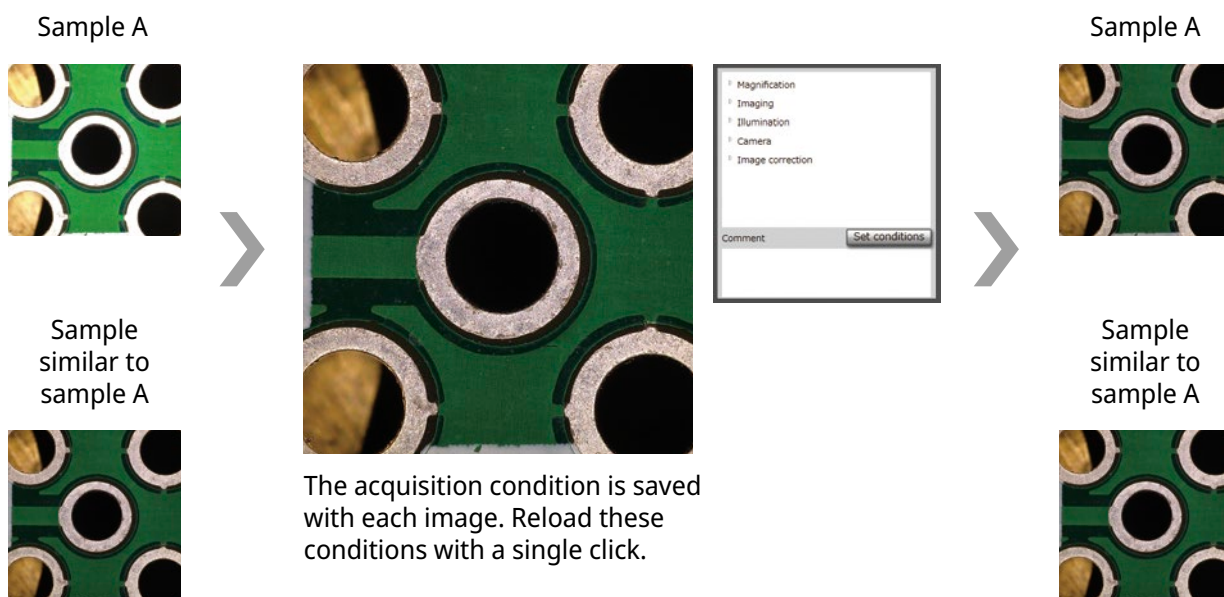

The acquisition condition is saved with each image. Reload these conditions with a single click.

Quickly retrieve image acquisition conditions for efficient analysis.

Integrated Observation Methods

Easily switch between brightfield (BF), oblique, darkfield (DF), MIX (BF and DF), simple polarization (PO), differential interference contrast (DIC), and contrast enhancement observation functions. This flexibility enables you to handle almost any microscope inspection task.

MIX (BF+DF)

Light comes from a ring around the lens

Easily detect scratches and defects that can be hard to find with a conventional microscope by combining the detection capabilities of darkfield (DF) to the visibility of brightfield (BF).

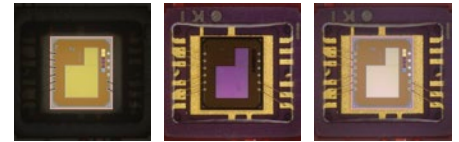
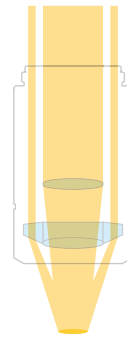

BF

DF

MIX

BF (Brightfield)

Good for flat samples

On a mirrored surface, scratches look dark against the surface, helping them stand out.

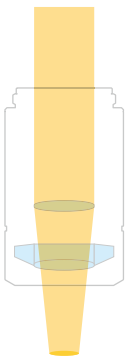

PO (Polarization)

Designed for polarizing samples

By orthogonally laying out two polarization filters, this method enables you to see the contrast and color according to your sample's polarization property.

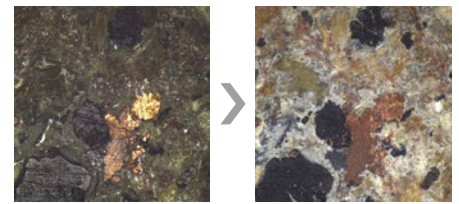
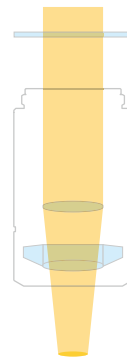

OBQ (Oblique)

Enhance your surface's unevenness

Use this method to enhance a surface's unevenness by shining the light from only one direction. This method is ideal for uneven or corrugated samples and cutting traces.

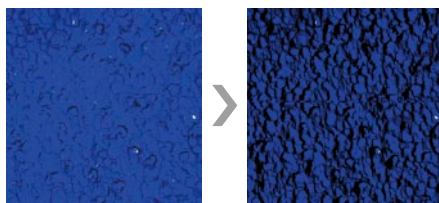
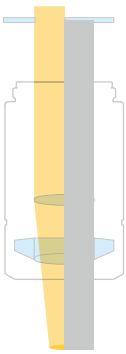

DIC (Differential Interference Contrast)

Visualize unevenness, foreign particles, scratches, and other defects at the nano level

This method enables you to visualize surface unevenness at the nano level. It is ideal for inspecting wafers, film, LCD ACF, and glass surfaces.

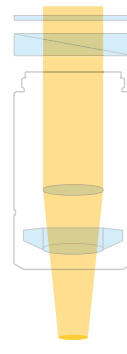

DF (Darkfield)

Best for detecting scratches and similar defects

Scattering or reflected light is obliquely irradiated on the sample's surface, highlighting dust, scratches, and other objects. Dust and scratches appear bright in the visual field.

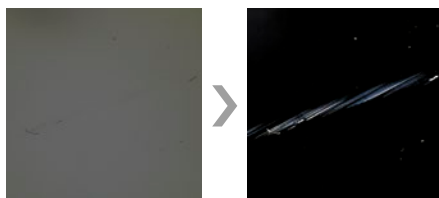
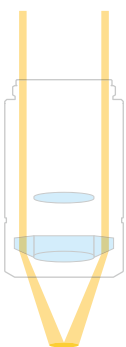

Contrast Up

Emphasize your sample's contours

This method enhances the contrast by narrowing the optical element's aperture stop, enabling you to see sharp, vivid images. The bright parts look brighter, while the dark parts look darker.

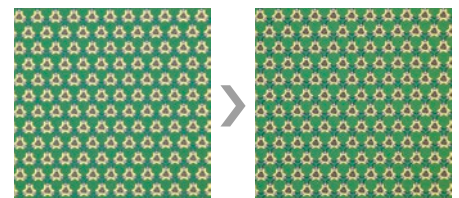
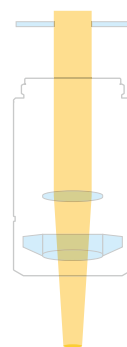

More Easily View Scratches with Differential Interference Contrast

Defects like scratches that are not visible in brightfield are easier to see using differential interference contrast.

BF: Surface unevenness cannot be observed.

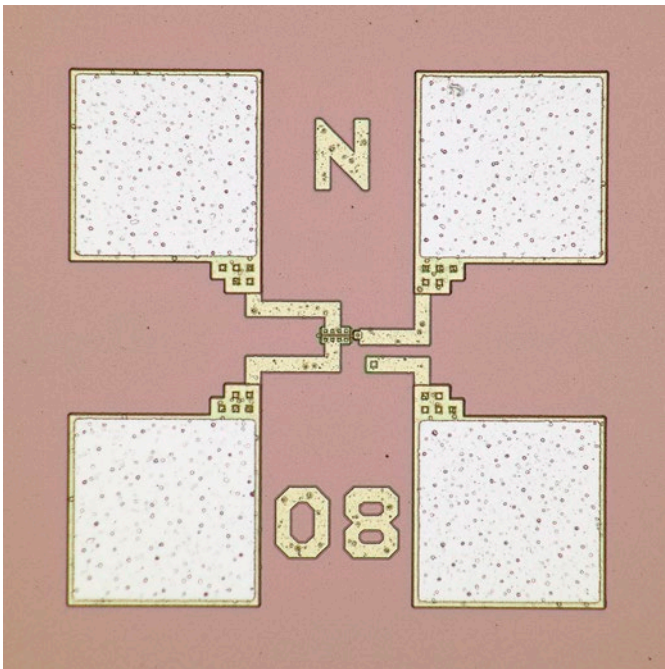

DIC: Scratches that could not be confirmed by brightfield observation can be confirmed.

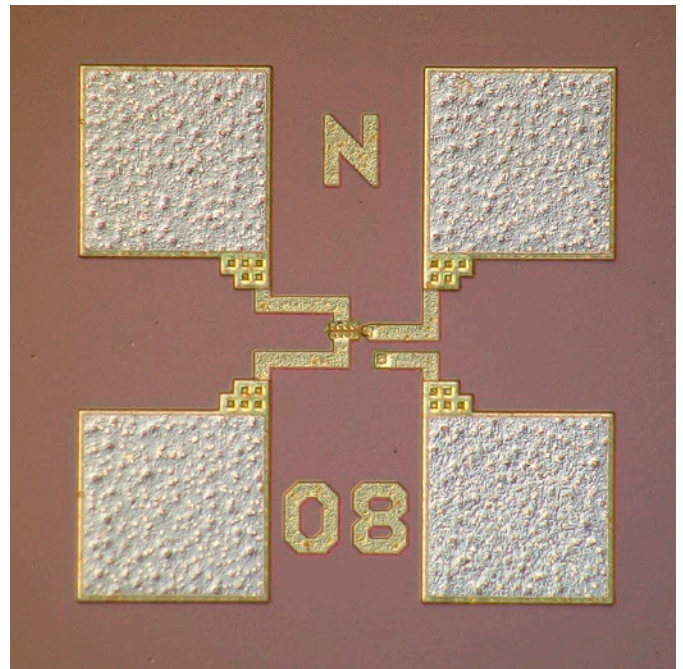

IC tip

Evaluate Strain Using Polarization

BF: The amount of strain cannot be observed.



PO: The strain of each part can be confirmed by contrast and color according to the polarization characteristics.



Plastic molded product

Change Magnification Quickly and Easily

With some digital microscopes, you need to replace the objective lens to adjust the magnification. This can be a slow process, potentially requiring you to remove the camera cable each time and restart the software. During this process, you might lose your view on the object, forcing you to spend time navigating back to the correct spot.

The DSX1000 digital microscope enables you to easily and quickly change magnification from the macro to the micro range, minimizing the chance of losing the target object.

Quick Magnification Change with a Sliding Nosepiece

You can attach two objective lenses to the head at the same time and quickly change the magnification just by sliding the lens.

Instantly Switch the Lens Attachment

Objective lenses can be quickly switched, enabling you to find the best magnification for your inspection. When the lens is replaced, magnification and visual field information will automatically be updated.



Fast Motorized Optical Zoom

Optically zoom in and out by turning the console dial. The optical zoom head covers a wide range of magnifications with a single objective. It is fully motorized, helping you to eliminate common errors that may occur when manually setting the zoom.



Knob dial

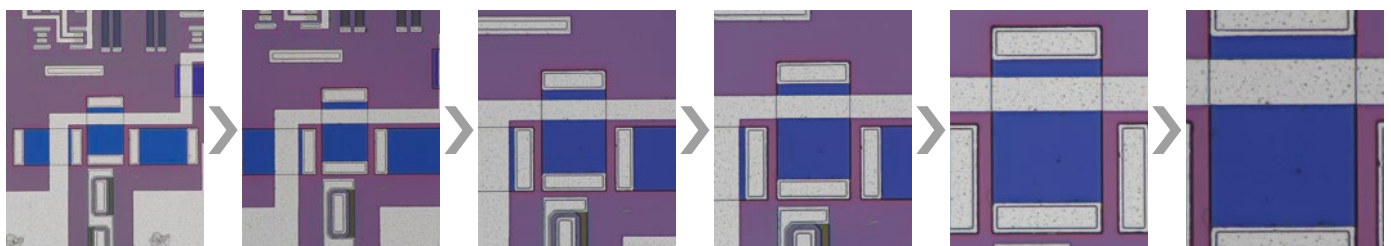
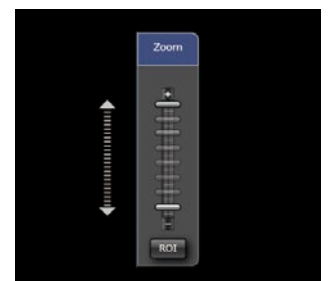

Enlarge a Specified Area with ROI Zoom

Specify the position and size of the area you want to magnify when observing a live image and enlarge it. By specifying the area, you can quickly approach the measurement point.

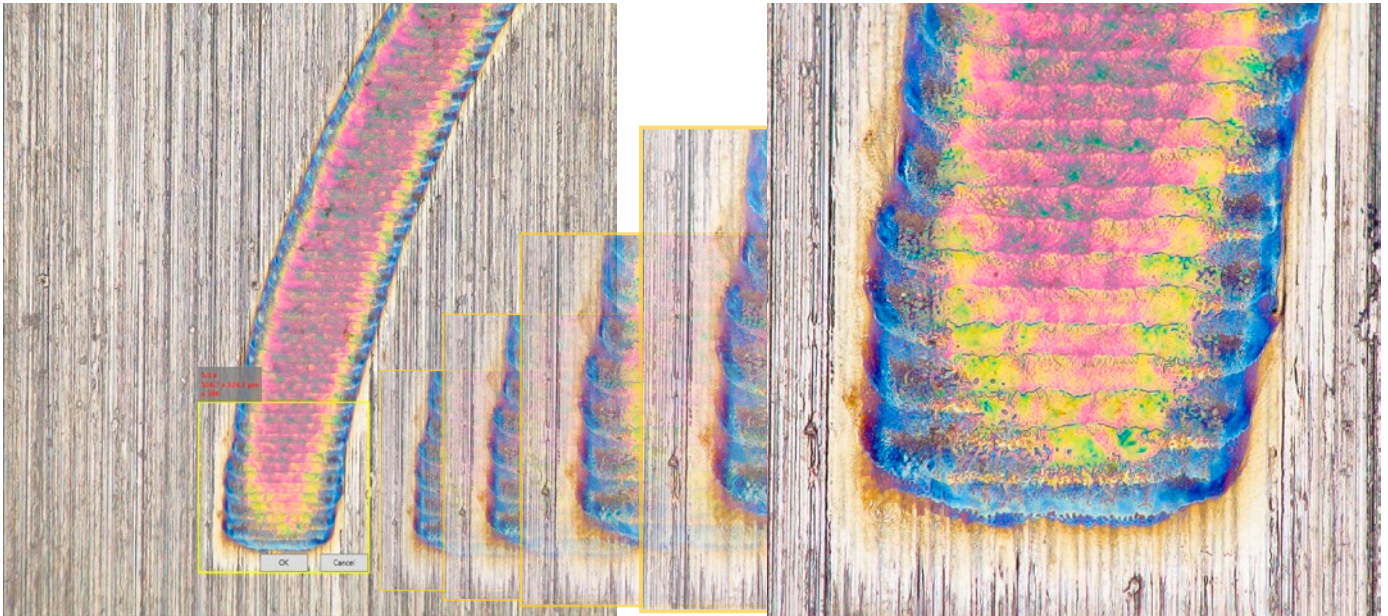

If you want to enlarge this area to fill the screen and observe it, move the yellow frame and click it. Then, the motorized stage and zoom will work together to make the adjustments.

Always Know Your Location on the Sample

The system displays the area you are currently observing within the whole image—even in zoom mode—so that you will not get lost.

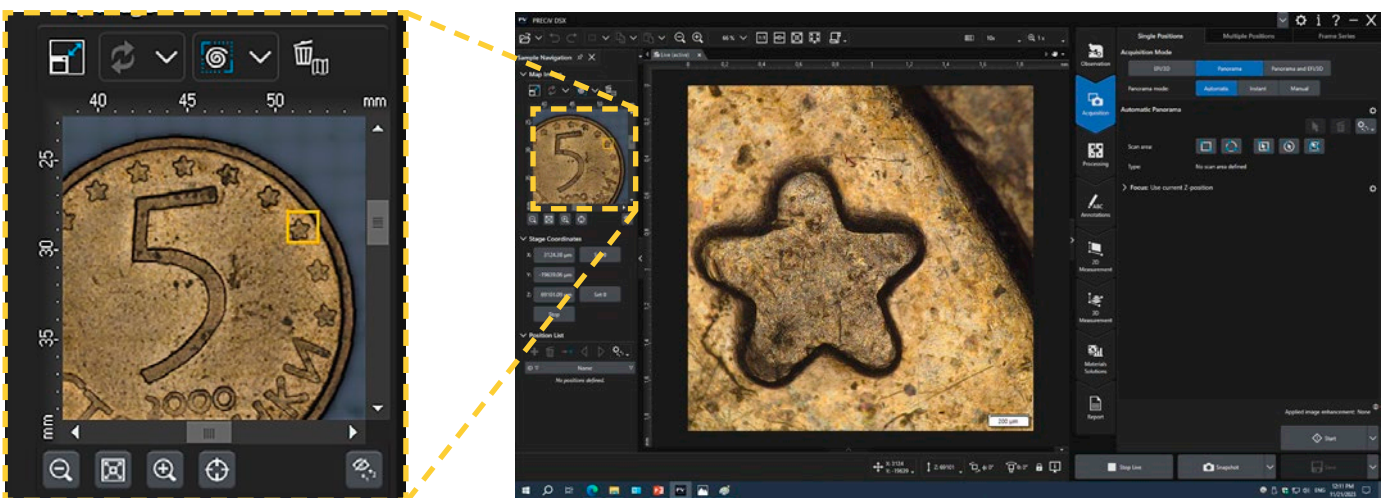

Be Confident in Your Results with Guaranteed* Accuracy and Precision



The microscope's telecentric optical system enables you to obtain very precise measurements, while the guaranteed accuracy and precision enable you to be confident in your results.

*To guarantee XY accuracy, the calibration must be performed by an Evident service technician

Guaranteed Measurement Precision

Be Confident in Your Measurements

The precision of many digital microscopes and optical microscopes is not guaranteed.

Many microscopes do not offer a calibration certificate

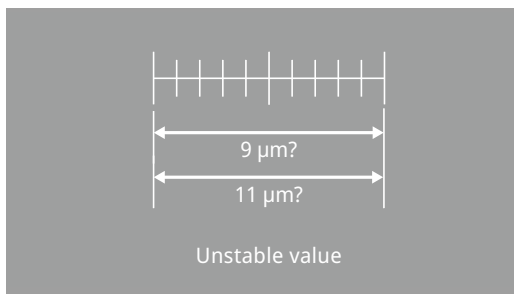

DSX1000 System with measurement accuracy

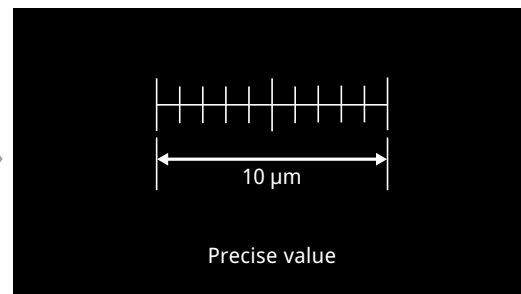

DSX1000

You can be confident in your measurement results with guaranteed measurement precision.

On-Site Calibration

Even if the measurement precision of your microscope was guaranteed at the time of factory shipment, those results can be changed once installed.

Conventionally there is no calibration certificate



DSX1000 System with calibration certificate



DSX1000

Reliable measurement with on-site calibration.

High-Precision Measurement

When imaging tall samples with a conventional microscope, you may suffer from a convergence effect where the size of the object can look different depending on the point of focus. This effect makes it difficult to take accurate measurements. The DSX1000 system's telecentric optics eliminate this effect to achieve better measurement accuracy.

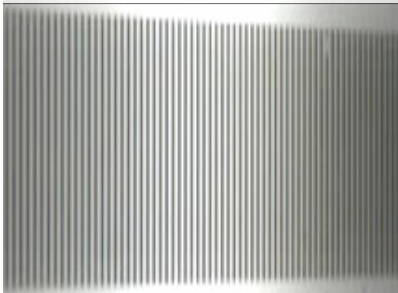
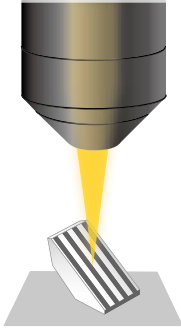
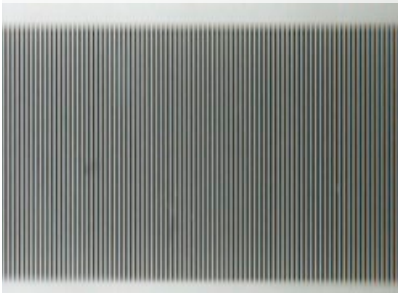
Conventional digital microscope (non-telecentric optical system)	DSX1000 Digital Microscope (telecentric optical system)
	
The size is different between the right and left edges in one visual field.	
	The size is the same between the right and left edges in one visual field.

What is a telecentric optical system?

Telecentric lenses have the same brightness at the center and edge of the visual field. Even if the sample moves vertically by adjusting the focus, the image size (magnification) does not change with telecentric lenses. This optical system enables you to capture an image of an entire sample faced up, which increases measurement precision.

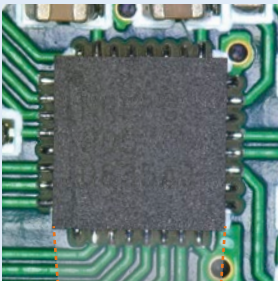
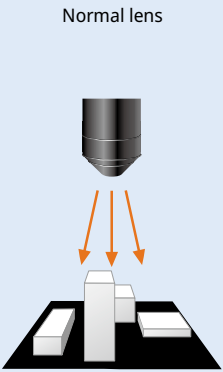
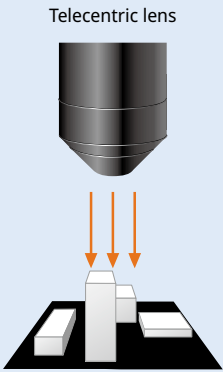
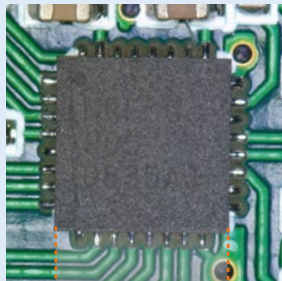
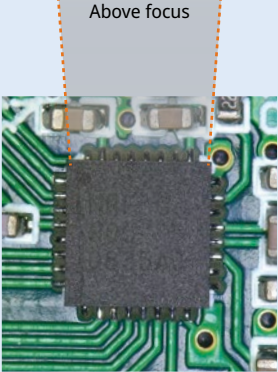
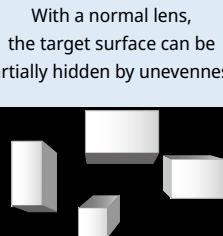
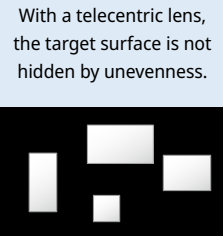
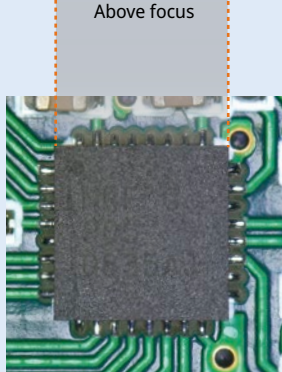
Non-telecentric optical system	Telecentric optical system		
When measuring the distance between two points in the images above and below focus, results can differ.	The measurement result is the same between the images above and below focus.		
	<p>Normal lens</p> 	<p>Telecentric lens</p> 	
	<p>With a normal lens, the target surface can be partially hidden by unevenness.</p> 	<p>With a telecentric lens, the target surface is not hidden by unevenness.</p> 	
Below focus	The images are different in size.	The image size is the same.	Below focus

Guaranteed Accuracy and Repeatability

Measurement accuracy and repeatability are guaranteed at all magnifications, so you can be confident with your measurement results.

Measurement object: 1.00 mm standard scale

Measurement count	Measurement result
1	1.0 mm
2	1.02 mm
3	0.99 mm
4	1.01 mm
5	1.0 mm
6	1.0 mm
7	0.99 mm
Measurement count	Average value
7	1.00 mm

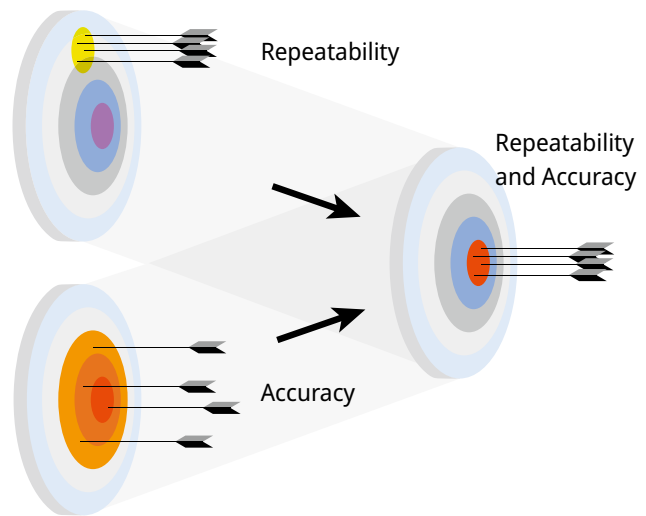

- To issue certificates, calibration work must be undertaken by Evident's dedicated service staff.
- Evident issues the calibration certificate.

Guaranteed Measurement Performance in Your Working Environment

When you purchase a DSX1000 system, the calibration will be done by a technician at your site to guarantee the same level of precision as when the system was shipped from the factory.

A variety of certifications

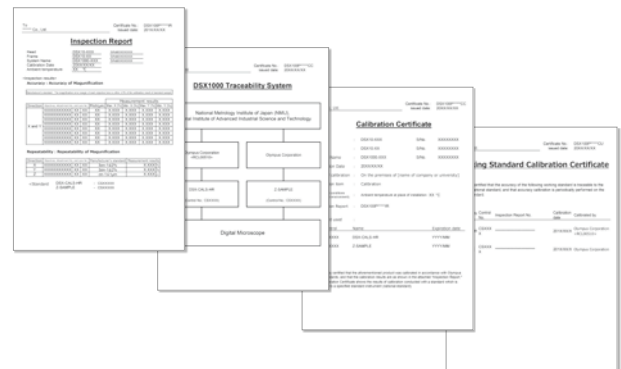

Keep Your Measurements Precise

To further reduce fluctuation in measurement precision, the objective lenses and zoom ratios need to be calibrated. Normally, this is a time-consuming process, but calibration settings can be done quickly and easily by the auto calibration feature.

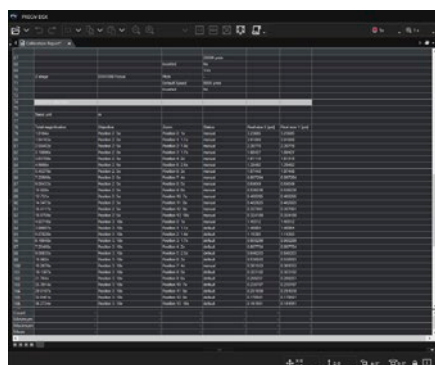

Calibration sample

Advanced Measurements Are Fast and Easy to Obtain

PRECiV DSX

PRECiV is the imaging platform for our industrial microscopes and accessories. PRECiV DSX is the dedicated digital microscope version, offering fast, efficient inspection workflows for image acquisition, quantitative 2D/3D measurement and image analysis, and advanced material solutions. This powerful yet easy-to-use software is available in 10 languages.

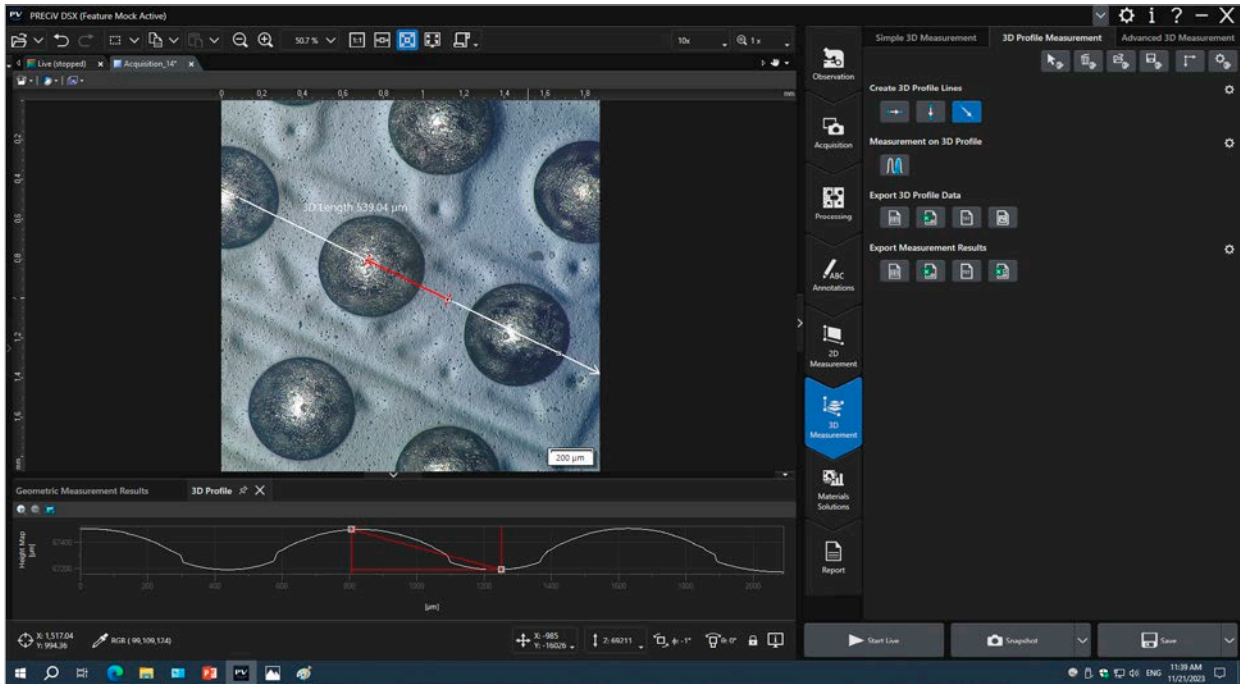

Advanced Measurement Functions

3D Analysis Application

PRECiV supports 3D line profile measurements, advanced 3D measurements, and surface roughness analysis of 3D images acquired with the DSX1000 using an optional PV-3DAA. The image is automatically transferred from PRECiV DSX to the 3D analysis application.

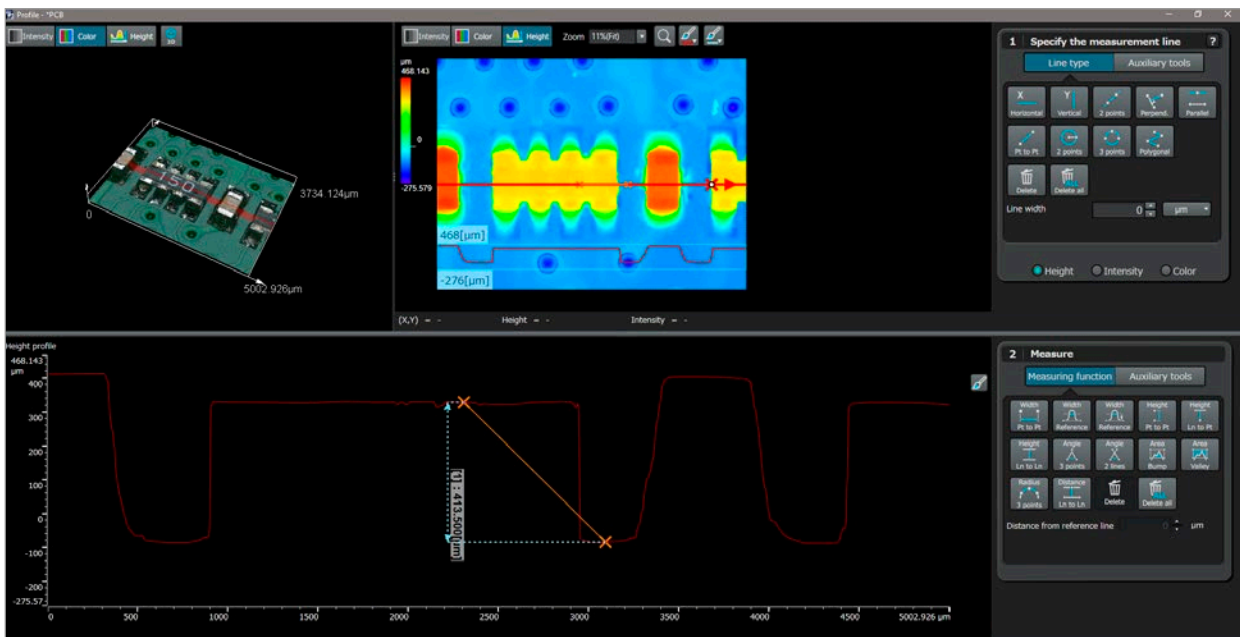

Advanced Features Simplify Analysis

One-click profile measurement Profile measurement

The profile measurement function displays the surface profile by arbitrarily drawing a measurement line on the position to be measured on an image. It also measures the step between any two arbitrary points, widths, crosssectional areas, and radii. Unlike contact-based measuring tools, setting the measurement positions is easy. You can check the measurement lines and points on the image, so even a very small site can be measured accurately.

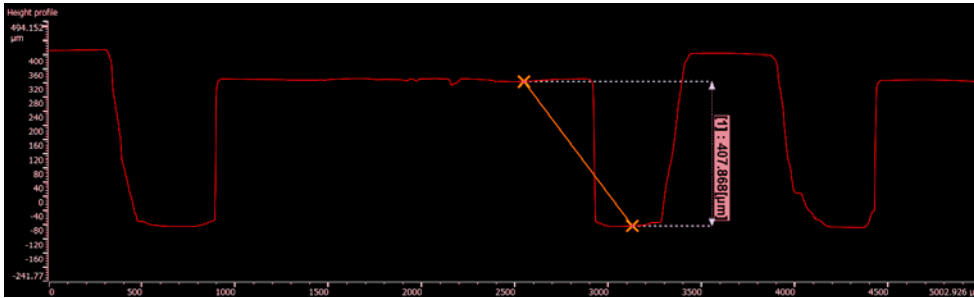

Automatically extract feature points Profile assist tool

The desired measurement line can be designated by specifying the maximum/minimum points on the specified site, the intersection of two lines, center of a cylinder, or center of a sphere. When a site is specified in the acquired data, feature points are automatically extracted according to specified conditions, reducing operator-related variations.

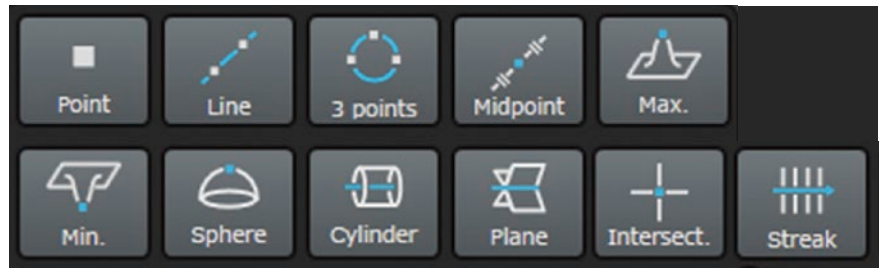
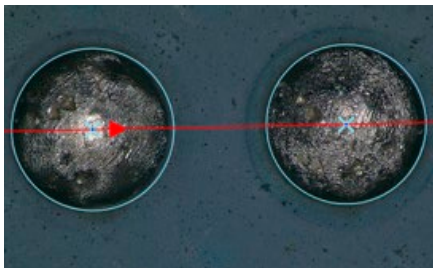

Automatically extract feature points Measurement assist tool

The point to be measured can be correctly specified using the highest, lowest, middle, and/or mean points. Once the measurement site is defined, the measurement data is automatically acquired.

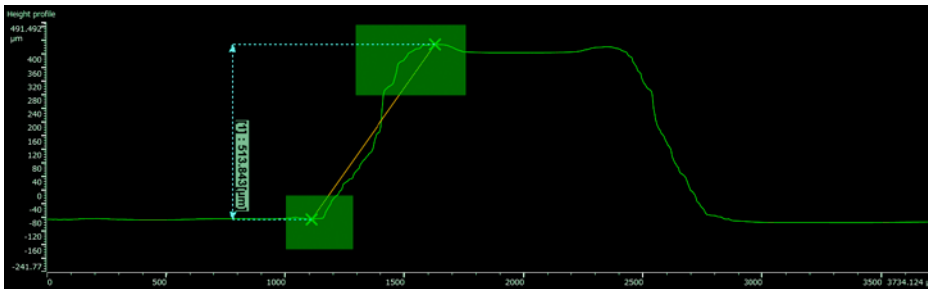

Measurement of the step between the highest and lowest points in a surface profile



Compare heights with a reference plane Step height measurement

Specifying the height reference site and the measurement site that will be used as a comparison target in the acquired data enables you to quantify the maximum, minimum, and average step differences between the reference and measured sites. The specified sites can be saved and loaded later, making this function ideal for repeated measurements.

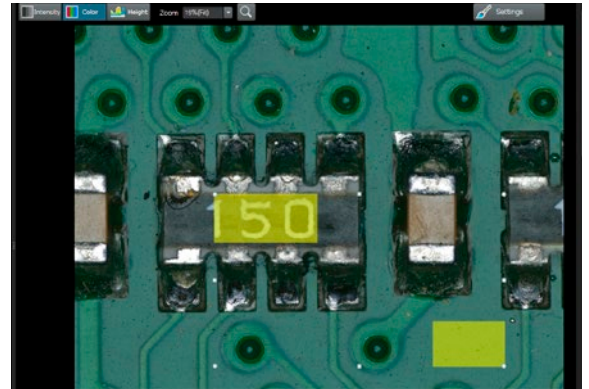

Confirm differences in data visually and quantitatively Difference measurement

Differences including go/no-go judgments, shape (height) differences before/after wear, surface areas, and volumes can be confirmed visually and quantitatively. With just a single click, you can align the position between XYZΦ data, making it easy to analyze the differences in surface shapes.

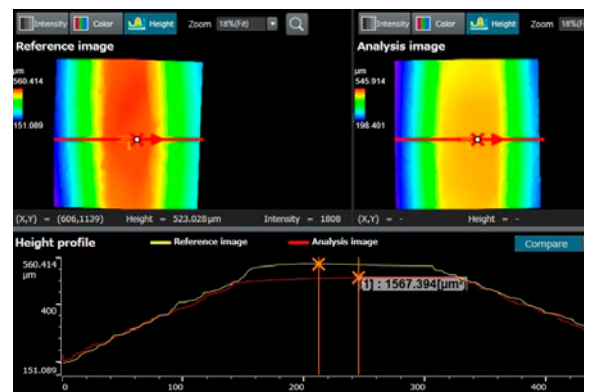

Surface Roughness Measurement

You can easily see the picture of surface condition by performing line and surface roughness measurement quantitatively, using Ra and Rz parameters.

Analysis parameter			
Sg	401.406 (μm)	Ssk	-0.089
Skz	1.363	Sp	511.759 (μm)
Sv	746.314 (μm)	Sz	1258.073 (μm)
Sa	368.356 (μm)		

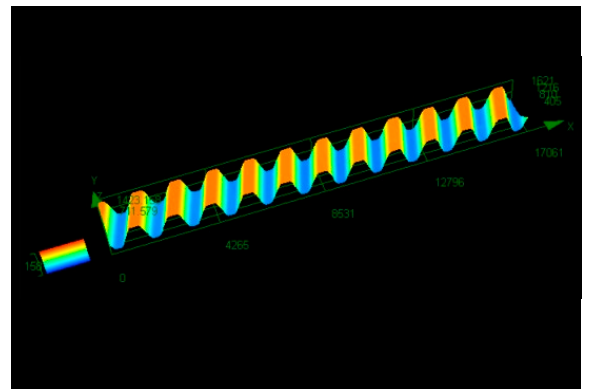

Application Solutions (optional)

Particle Distribution

Measuring the physical characteristics of particles is a common task in a wide range of industries and is often a critical parameter in the manufacture of many products. The particle distribution materials solution classifies particle parameters based on their morphology, including characteristics such as size, diameter, area, color, and elongation, and builds a graphical representation of the distribution. Class bins can be defined with color codes to give a better understanding of the results.

Key Features

- Counts the number of particles in one or multiple images (motorized solution)
- Classifies according to a selected dimension among a large number of choices
- Codes and validates results according to a user's standards

Typical Applications

- Reactivity of dissolution rate (ex. catalyst, tablets)
- Stability in suspension (ex. sediments, paints)
- Efficacy of delivery (ex. asthma inhalers)
- Texture and feel (ex. food ingredients)
- Appearance (ex. powder coatings and inks)

Particle distribution
(Particles extracted on membrane filter)

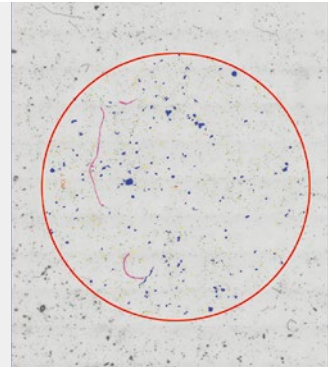

Graphite Nodularity Evaluation

This solution automatically evaluates graphite nodularity and content in cast iron samples (nodular and vermicular types). The form, distribution, and size of graphite nodes are classified according to EN ISO 945-1:2018, ASTM A247-17, JIS G 5502:2001, KS D 4302:2006, GB/T 9441-2009, ISO 16112:2017, JIS G 5505:2013, NF A04-197:2017, and ASTM E2567-16a (for nodularity only) standards. This solution also assists with determining the ferrite-pearlite ratio in cast iron cross sections.

Key Features

- Measure both the ferrite-pearlite ratio (on etched samples) and graphite distribution (on non-etched samples)
- Measure the distribution of vermicular graphite using standard charts
- Select from multiple standards

Typical Applications

- All cast iron samples (metallic parts requiring high strength, castability, etc.)

Cast iron solution
(Ductile cast iron showing nodular graphite)

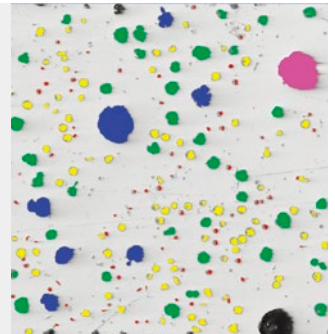

Layer Thickness Measurement

Measures layer thicknesses either perpendicular to neutral fibers, via the shortest distance, or with a parallel method. Users can now measure layers with even or uneven boundaries. Layer thickness measurement software calculates mean, maximum, and minimum values as well as statistical data for each layer. Layer boundaries can be specified using automatic detection, magic wand, or manual mode. Individual measurements can be added or deleted later.

Key Features

- Select different phases using automatic, magic wand, and manual measurement modes
- Automatic layer measurement is performed using the neutral fiber as reference layer
- Flexible selection of multiple points or inter-distance

Typical Applications

- CVD, PVD, plasma spray coatings
- Anodic oxidation layers
- Chemical and galvanic deposits
- Polymers, paints, and lacquers

Layer thickness solution
(Cross section of paint and primer lacquer on steel)

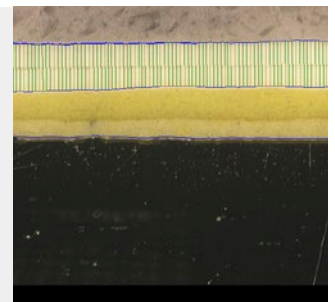

Automated Functions Ease Your Workflow

The DSX1000 microscope's automatic multipoint acquisition and measurement make your analyses more efficient from start to finish.

1. Define and create a position list for multipoint acquisition

Interactively register positions on the sample or by importing a position file. Align the sample to always return to the same position. Automatically acquire images at a given position (single frame, multiple frames, 3D stacks) using several focus methods.

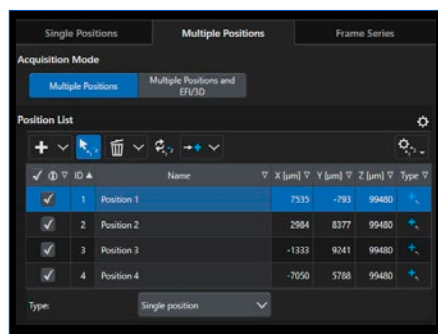

Multiple definition list

2. Automatic image processing registered using the position list

Choose your processing method, and the motorized stage automatically moves to each registered position and performs the analysis. Acquired images are automatically saved to your network.

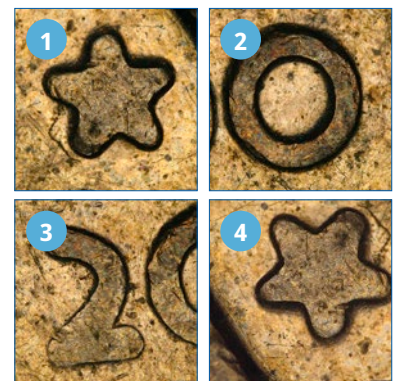
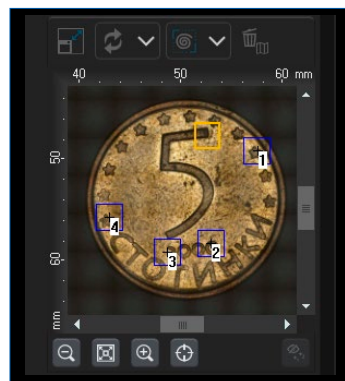

3. Store and recall observation conditions

Observation conditions are automatically stored with each image. Device settings can also be saved and recalled for reproducible observation conditions.

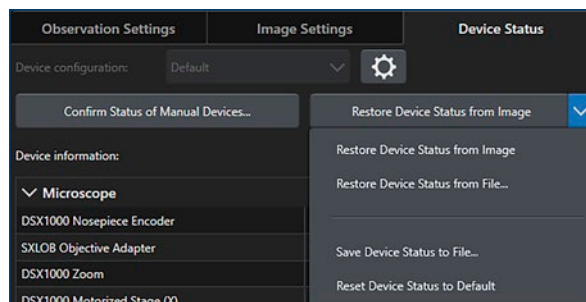

4. Automatically generate analytical reports in Microsoft Office 365

All operations and procedures included in a report can be saved as a template. Using the same template when repeating the measurements helps ensure consistency between reports and users.

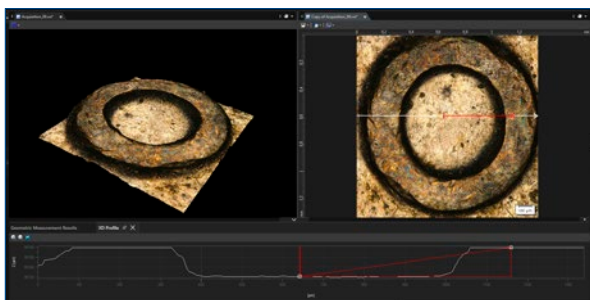

Conduct the inspection and take measurements

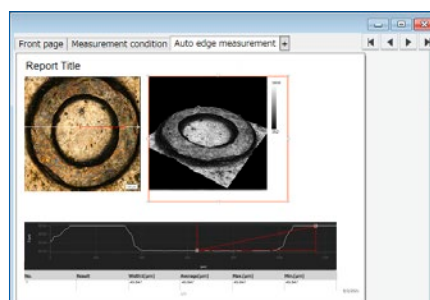

Instantly output a report based on the template

Easily Analyze Complex Images Using AI Technology

PRECiV DSX software with TruAI technology offers image analysis beyond classical algorithms. You can apply a trained neural network to your samples for higher reproducibility and more robust analysis. Choose between semantic or instance segmentation methods for improved neural network training, enabling you to tackle difficult applications in just one step.

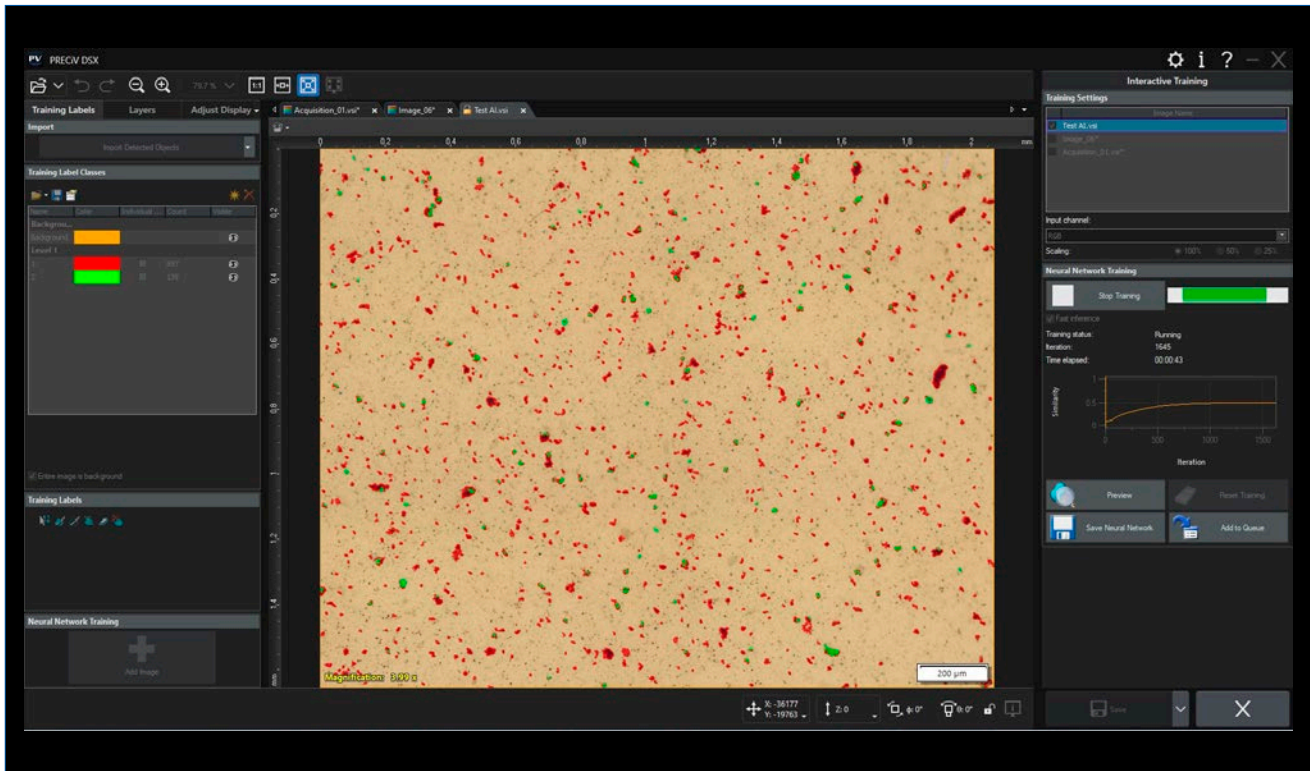

PRECiV TruAI™ technology also supports live AI, which uses a trained neural network (inference) to detect defects in your sample on the live image.* As an option, PRECiV TruAI technology can also count the defects it identifies on the live image as well.**

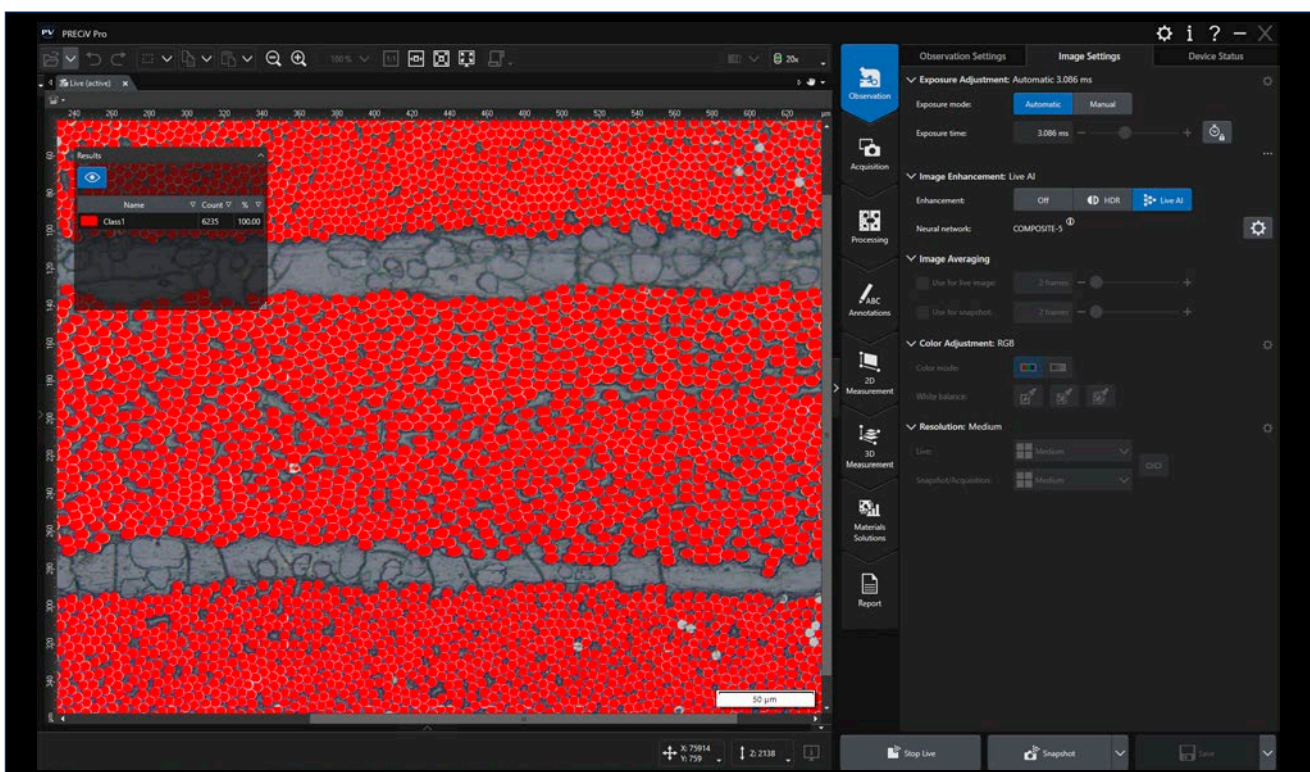

Live AI

*Using the optional neural network training module.

**Using the optional Count & Measure or dedicated Materials Solutions (phase analysis, particle distribution, porosity).

Semiconductor/Electronics

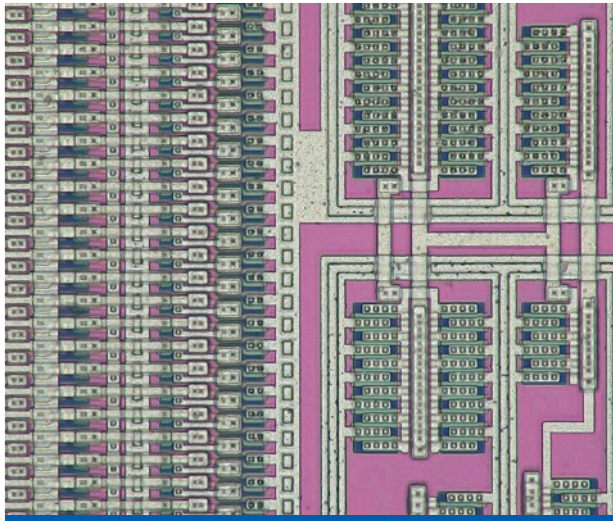

Wafer wiring

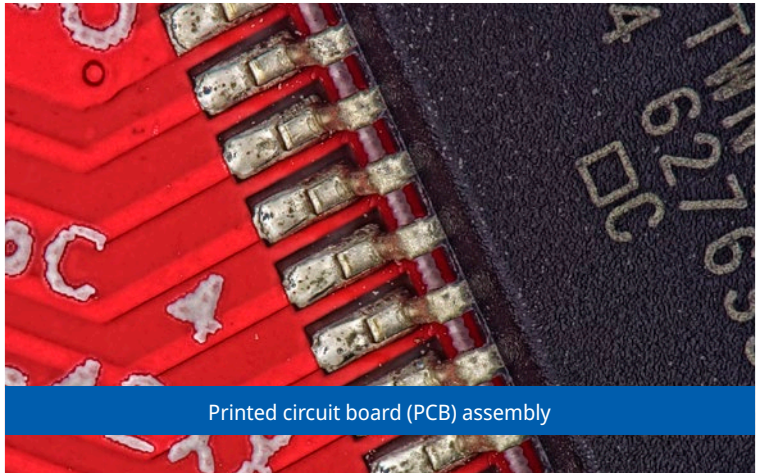

Printed circuit board (PCB) assembly

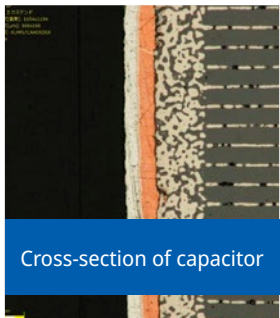

Cross-section of capacitor

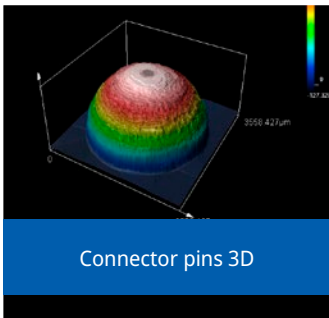

Connector pins 3D

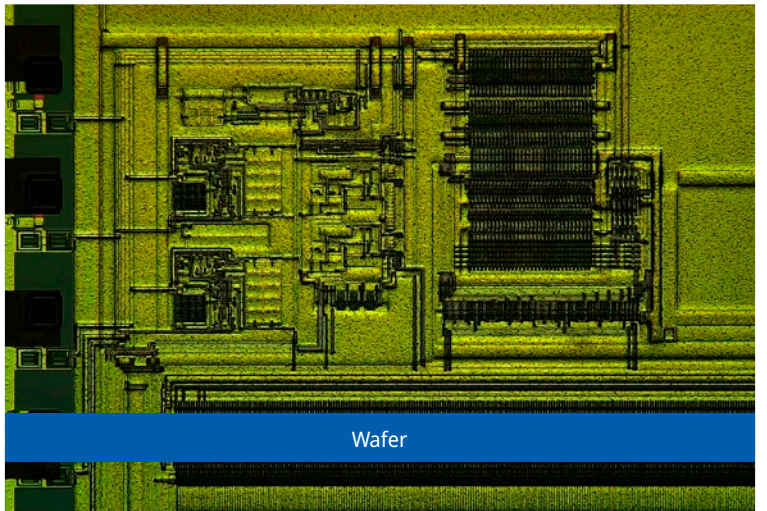

Wafer

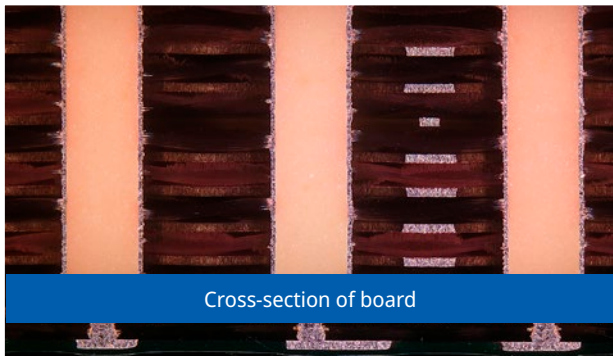

Cross-section of board

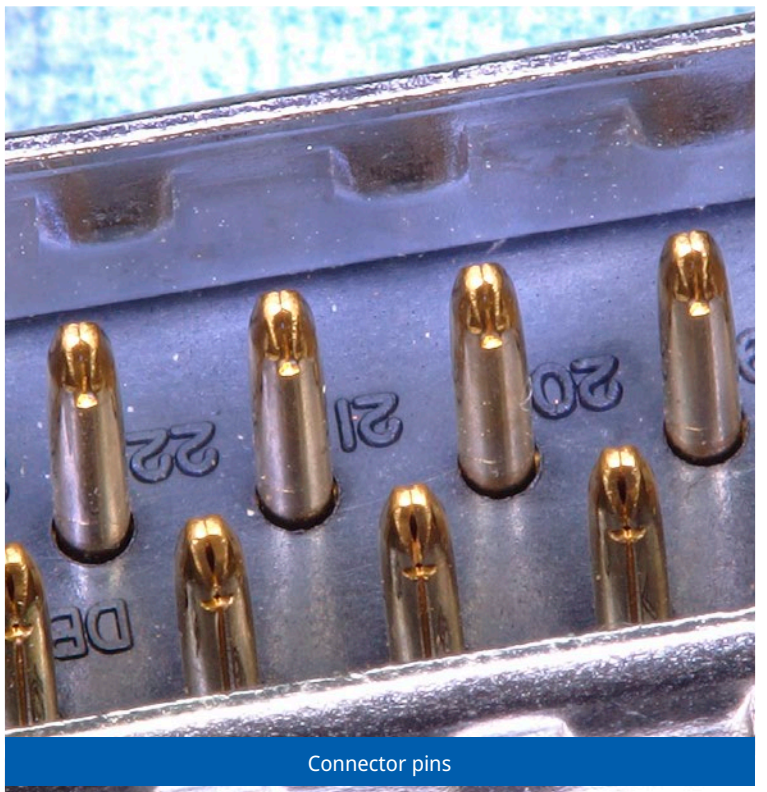

Connector pins

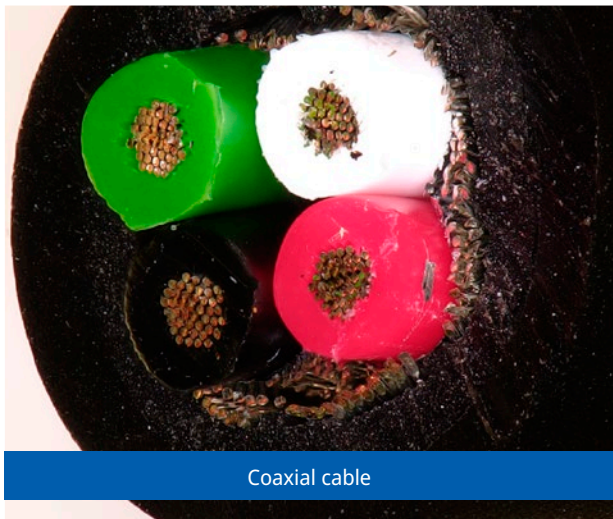

Coaxial cable

Automotive/Metal



Automotive coil

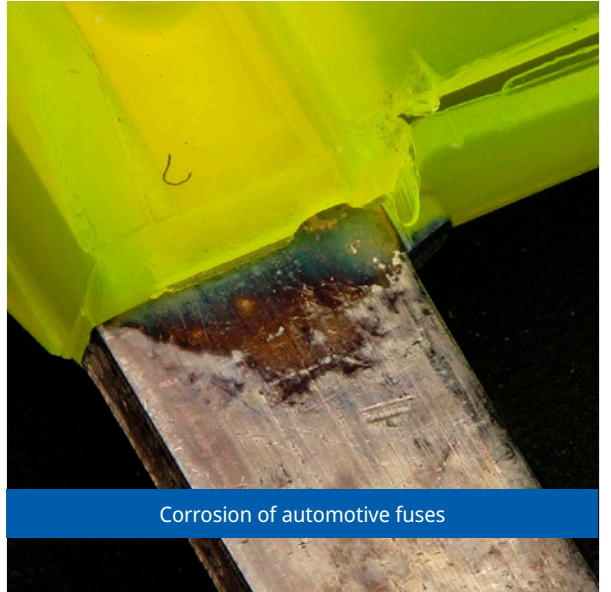

Corrosion of automotive fuses

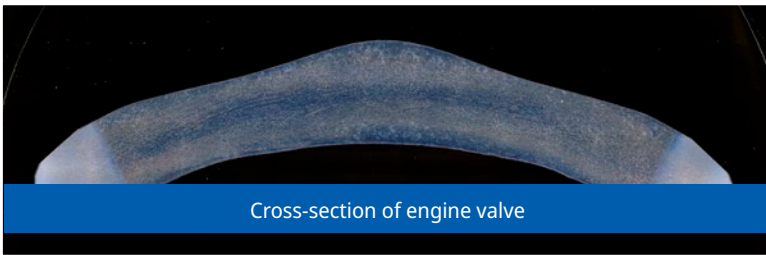

Cross-section of engine valve



Fracture surface



Radiator fin



Automotive LED tip

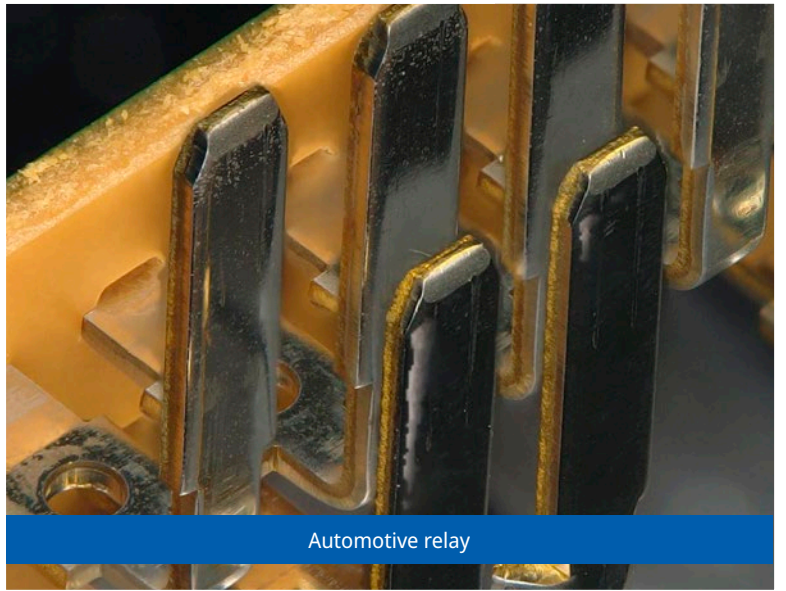

Automotive relay

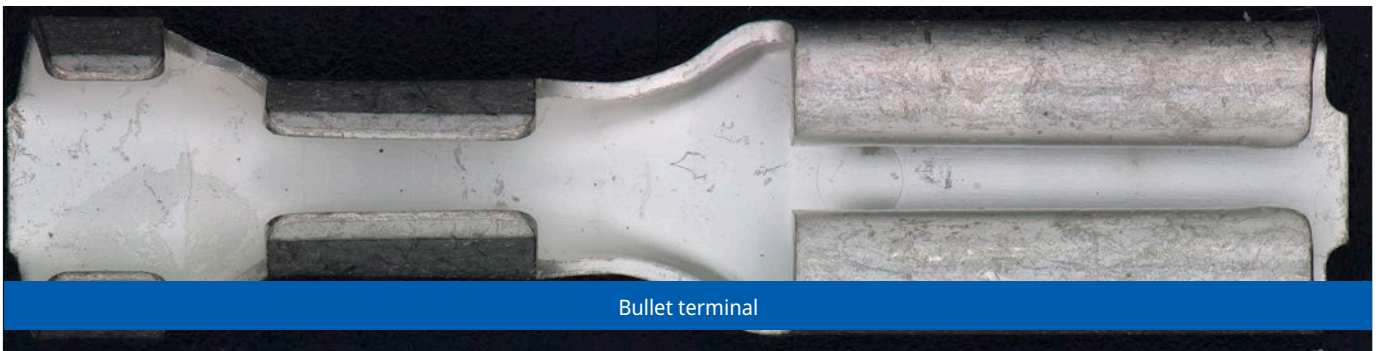

Bullet terminal

Material/Chemical



Resin molded product



Polyester fiber

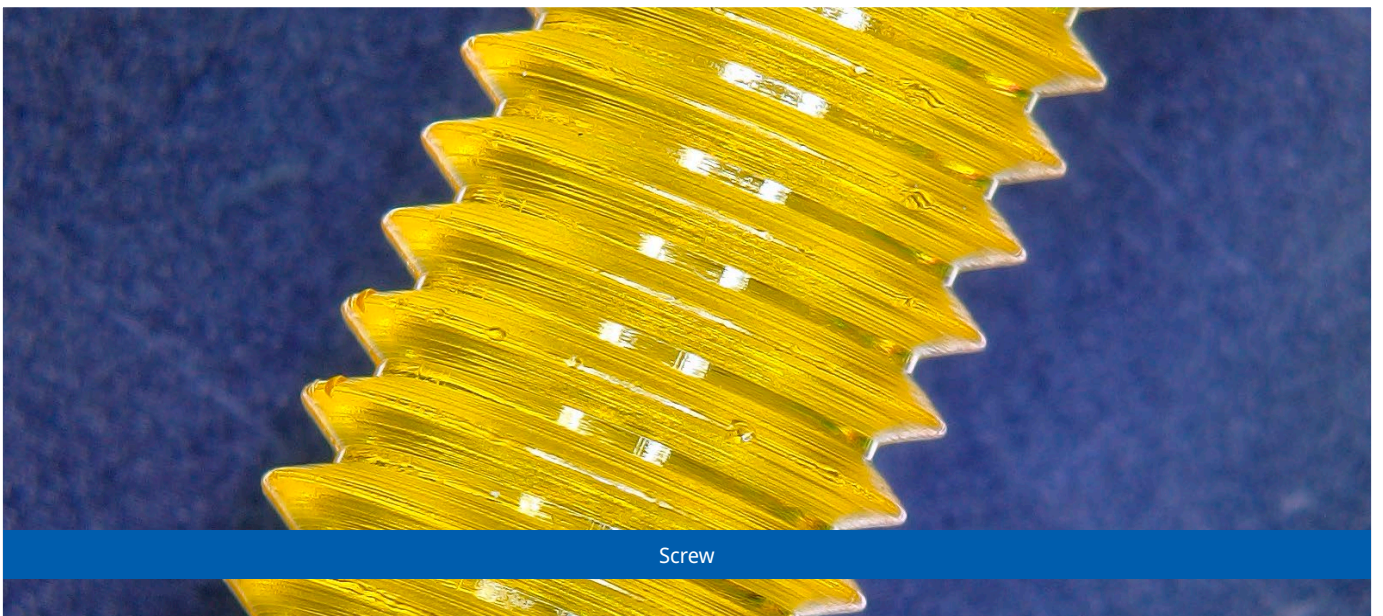

Screw



Gold plating

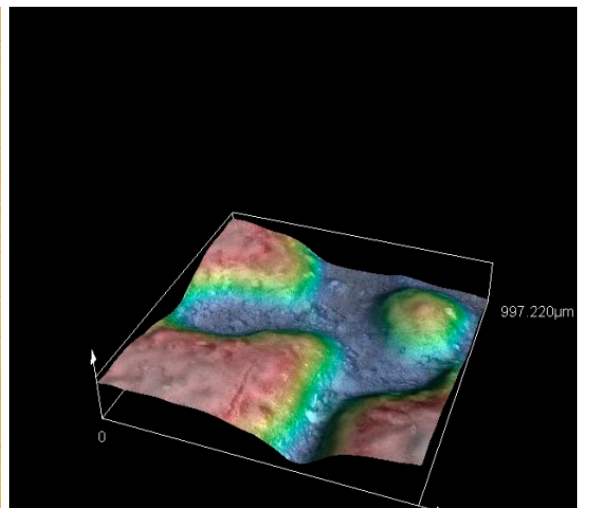

Emboss

Other Analysis Applications

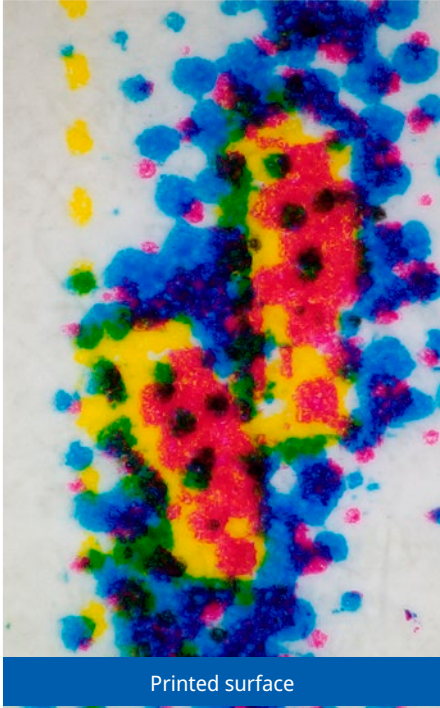

Printed surface



Glossy paper



Beetle



Beetle



Beads

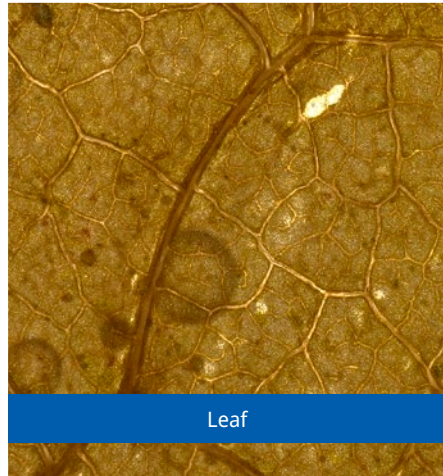

Leaf

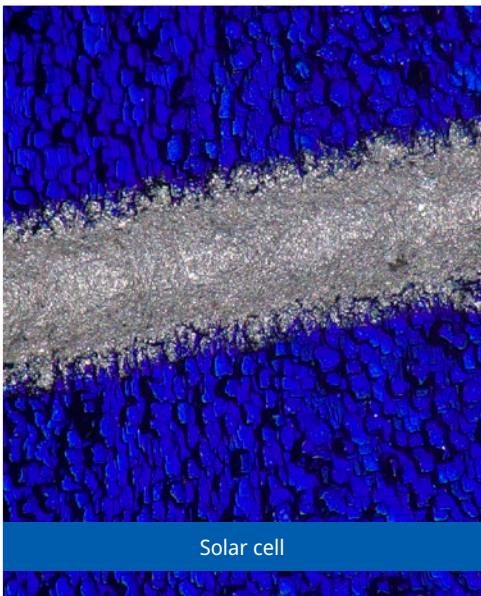





Solar cell

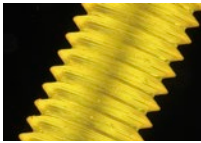
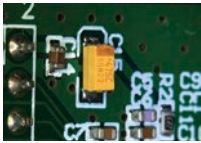
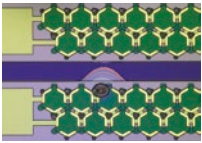
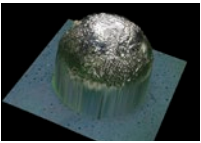

Rubber packing

DSX1000 Digital Microscope Models

Model			Entry model	Tilt model	High-Resolution model	High-End model
						
						
Model description			Basic functionality and easy to operate	Preferred for analyzing irregularly shaped samples	High-resolution images for advanced analysis	Analyze a wide variety of sample types using multiple observation methods
Standard equipment	Microscope motorized zoom head	Universal zoom head *DIC : Differential interference contrast *Depth of focus up *High-resolution 3CMOS mode	<input type="checkbox"/>		●	●
		Standard zoom head	●	●	<input type="checkbox"/>	
	Microscope frame	Observation method BF :Brightfield DF :Darkfield OB :Oblique MIX :MIX POL :Polarized light	●	●	●	●
		Tilting frame (±90°)	<input type="checkbox"/>	●	<input type="checkbox"/>	●
		Upright frame	●	<input type="checkbox"/>	●	<input type="checkbox"/>
	Stage	Motorized XY stage with rotation (±90°)			<input type="checkbox"/>	●
		Motorized XY stage	<input type="checkbox"/>	●	●	<input type="checkbox"/>
		Manual XY stage	●			<input type="checkbox"/>
	Console		<input type="checkbox"/>	●	●	●
	Software	Application software	Basic interactive measurements, 3D Line profile measurement and simple 3D measurements, 2D Line profile measurements, Advanced interactive measurement, including auto-edge detection and auxiliary lines, Neural Network Labelling, Live AI,Offline EFI, Offline Panorama, Image enhancement filters			
Others	Calibration sample	●	●	●	●	
	Controller PC/Display monitor					
Option	Transmitted lighting		<input type="checkbox"/>	<input type="checkbox"/>	<input type="checkbox"/>	<input type="checkbox"/>
	Adapter	Diffusion adapter	<input type="checkbox"/>	<input type="checkbox"/>	<input type="checkbox"/>	<input type="checkbox"/>
		Eliminate reflection adapter	<input type="checkbox"/>	<input type="checkbox"/>	<input type="checkbox"/>	<input type="checkbox"/>
	Software	3D Analysis Application	<input type="checkbox"/>	<input type="checkbox"/>	<input type="checkbox"/>	<input type="checkbox"/>
		Count and Measure	<input type="checkbox"/>	<input type="checkbox"/>	<input type="checkbox"/>	<input type="checkbox"/>
		Neural Network Training	<input type="checkbox"/>	<input type="checkbox"/>	<input type="checkbox"/>	<input type="checkbox"/>
		Material Solutions	<input type="checkbox"/>	<input type="checkbox"/>	<input type="checkbox"/>	<input type="checkbox"/>
		Auto edge measurement	<input type="checkbox"/>	<input type="checkbox"/>	<input type="checkbox"/>	<input type="checkbox"/>
		Particle analysis	<input type="checkbox"/>	<input type="checkbox"/>	<input type="checkbox"/>	<input type="checkbox"/>
		Sphere/cylinder surface angle analysis	<input type="checkbox"/>	<input type="checkbox"/>	<input type="checkbox"/>	<input type="checkbox"/>
	Experimental total assist* (Multi-data analysis function)	<input type="checkbox"/>	<input type="checkbox"/>	<input type="checkbox"/>	<input type="checkbox"/>	
	Others	Objectives strage case	<input type="checkbox"/>	<input type="checkbox"/>	<input type="checkbox"/>	<input type="checkbox"/>

*Please use acquired images when using the Smart Experiment Manager.

● : Standard □ : Option

System Diagram

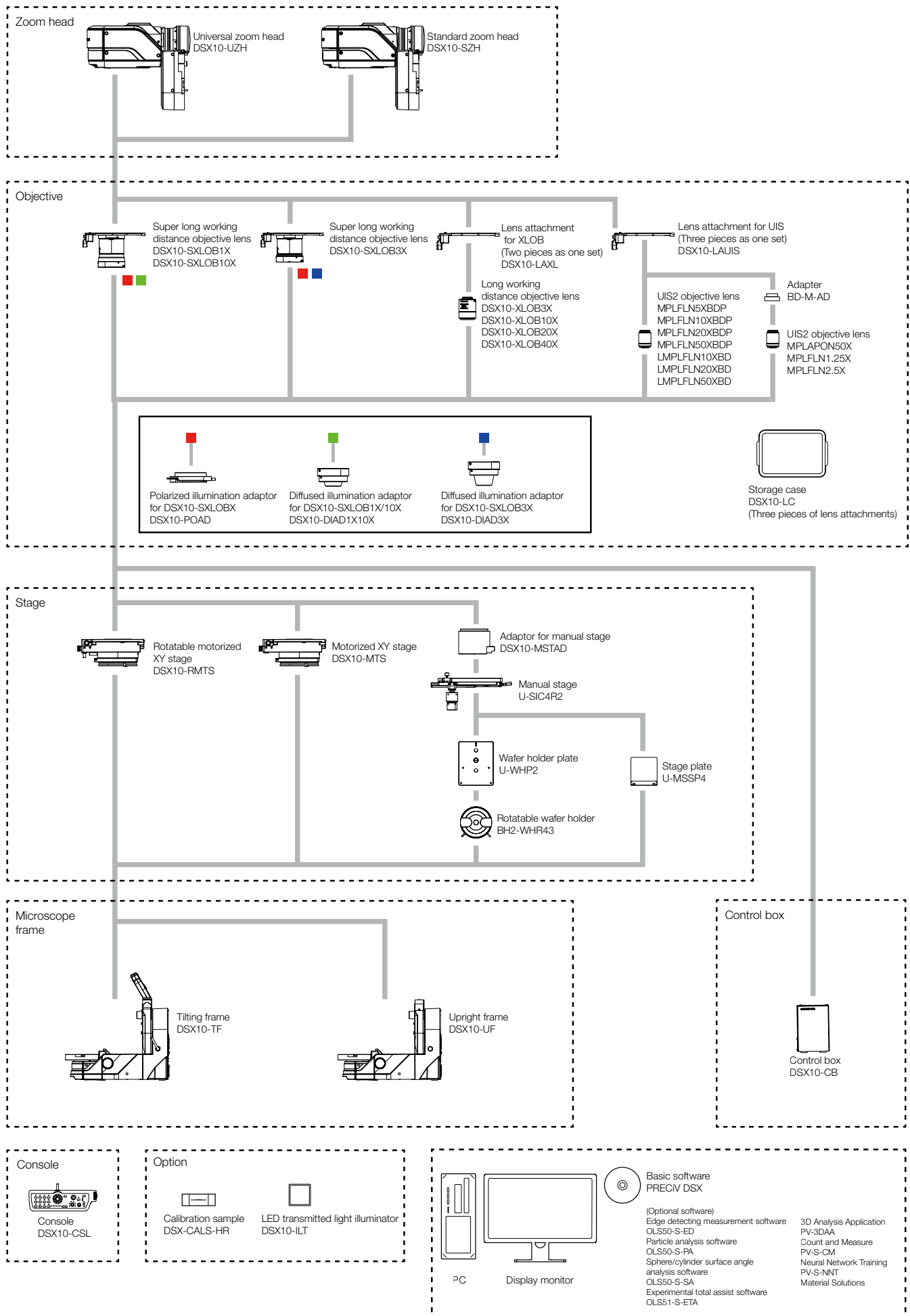

Objective Lenses

Super long working distance objective lenses

- Provides a long working distance between the lens and sample



High-resolution, long working distance objective lenses

- Delivers both high resolution and a long working distance



High-performance, high NA objective lenses

- Delivers high performance at the nano scale



Magnification on monitor 20X 40X 100X 200X

Objective lens model	20X	40X	100X	200X
DSX10-SXLOB1X	27-193x			
DSX10-SXLOB3X		58-578x		
DSX10-SXLOB10X				
DSX10-XLOB3X		58-578x		
DSX10-XLOB10X				
DSX10-XLOB20X				
DSX10-XLOB40X				
MPLFLN1.25X	34-241x			
MPLFLN2.5X		53-482x		
MPLFLN5XBDP		96-964x		
MPLFLN10XBDP				
MPLFLN20XBDP				
MPLFLN50XBDP				
MPLAPON50X				
LMPLFLN10XBD				
LMPLFLN20XBD				
LMPLFLN50XBD				

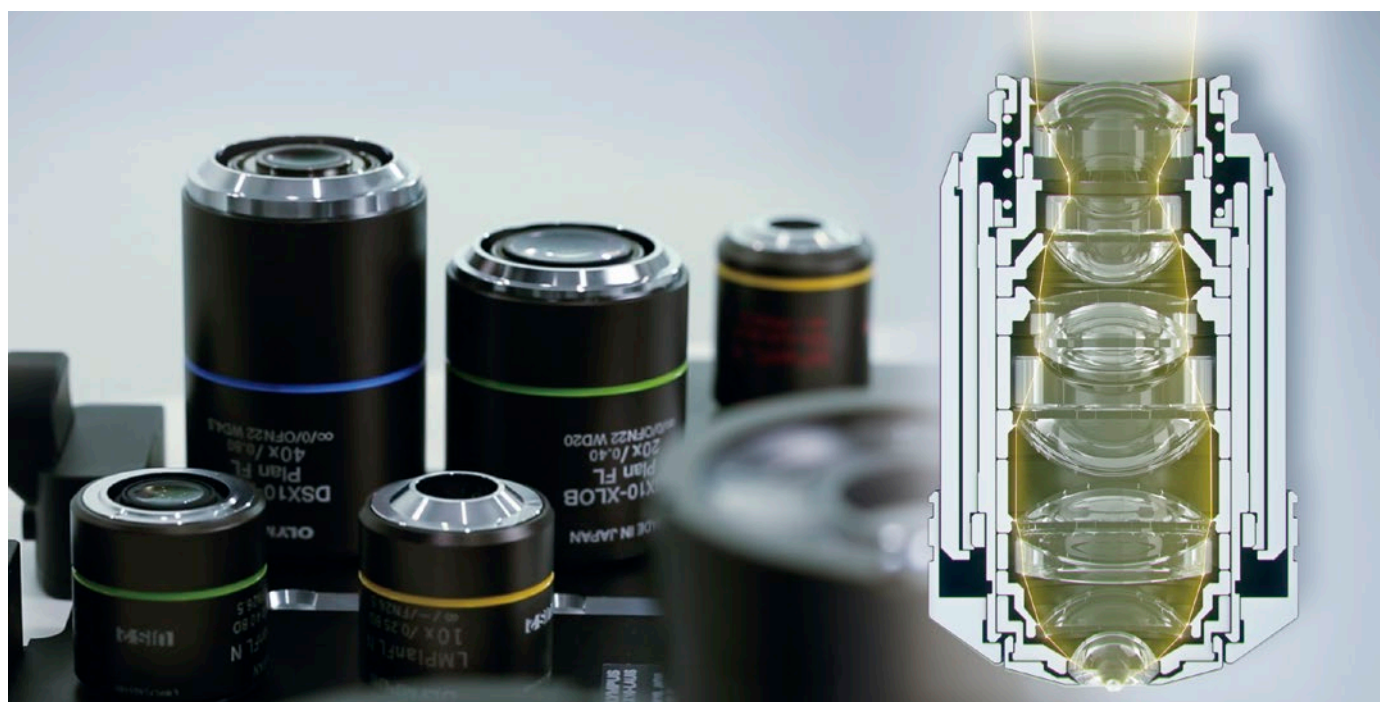

500X	1000X	3000X	6000X	10000X	Working Distance (mm)	NA	Field of View (μm)
					51.7	0.03	19,200 – 2,740
					66.1	0.09	9,100 – 910
193-1927x					41.1	0.20	2,740 – 270
					30.0	0.09	9,100 – 910
193-1927x					30.0	0.30	2,740 – 270
386-3855x					20.0	0.40	1,370 – 140
771-7710x					4.5	0.80	690 – 70
					3.5	0.04	17,100 – 2,190
					10.7	0.08	10,200 – 1,100
					12.0	0.15	5,480 – 550
193-1927x					6.5	0.25	2,740 – 270
386-3855x					3.0	0.40	1,370 – 140
964-9637x					1.0	0.75	550 – 55
964-9637x					0.35	0.95	550 – 55
193-1927x					10.0	0.25	2,740 – 270
386-3855x					12.0	0.40	1,370 – 140
964-9637x					10.6	0.50	550 – 55

*Magnification is based on a 27-inch monitor, 1:1 display, at 100% image magnification

*The DSX10-SXLOB1, 3, 10X, and DSX10-XLOB3X do not support PO observation.

*The MPLAPON50X does not support DF and mixed observations.

*The MPLFLN1.25, 2.5X support BF and OBQ observations.

*Field of view: At aspect ratio 1:1 diagonal.

Our lens processing system

We created an automatic lens processing system to deliver the highest possible quality optics. As a result, we can now process high-precision lenses as fine as 1/10,000 mm.



Our advanced engineer development program leads to Yellow Ribbon Medal

In 2018, we were awarded a Yellow Ribbon Medal for developing an advanced method to process high-precision objective lenses up to 2 μm. As part of the program, senior engineers mentored younger engineers in the art and science of lens manufacturing.

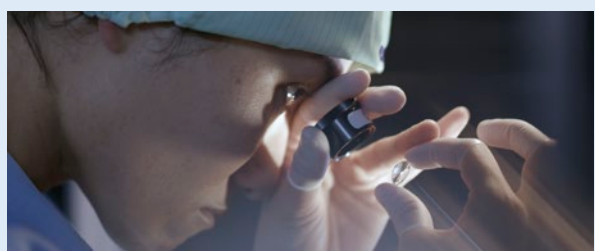

Specifications

Main Unit Specifications

		DSX10-SZH	DSX10-UZH	
Optical system	Optical system	Telecentric optical system		
	Zoom ratio	10X (motorized)		
	Zoom magnification method	Motorized		
	Calibration	Automatic		
	Lens attachment	Quick-switch, coded lens attachments automatically update magnification and visual field information		
	Maximum total magnification (on a 27-inch monitor 1:1 display, at 100% image magnification)	9,637X		
	Working distance (W.D.)	66.1-0.35 mm		
	Accuracy and repeatability (X-Y plane)	Accuracy ^{*1}	± 3%	
		Repeatability $3\sigma_{n-1}$	2%	
Repeatability (Z axis) ^{*2}	Repeatability σ_{n-1}	1 μ m		
Camera	Image sensor	1 / 1.2-inch, 2.35-million pixel color CMOS		
	Cooling	Peltier cooling		
	Frame rate	60 fps (maximum)		
	Low	960×600 (16:10)		
	Medium	1600×1200 (4:3) / 1920×1080 (16:9) / 1920×1200 (16:10) / 1200×1200 (1:1)		
	High (pixel shift mode)	2880×1800 (16:10)		
	Super high (pixel shift mode)	5760×3600 (16:10)		
	3CMOS mode (High quality)	Not available	Available (high and ultra high mode only)	
Illumination	Color light source	LED		
	Lifetime	60,000 h (design value)		
Observation	BF (brightfield)	Standard		
	OBQ (oblique)	Standard		
	DF (darkfield)	Standard LED ring divided into four divisions		
	MIX (brightfield+darkfield)	Standard Simultaneous observation of BF + DF		
	PO (polarization)	Standard		
	DIC (differential interference)	Not available	Standard	
	Contrast up	Standard		
	Depth of focus up function	Not available	Standard	
	Transmitted lighting	Standard ^{*3}		
Focus	Focusing	Motorized		
	Stroke	101 mm (motorized)		

*1 Calibration by Evident or dealer service technician necessary. To guarantee the accuracy of XY, calibration with DSX-CALS-HR (calibration sample) is required.

*2 When used 20X or higher objective. *3 The optional DSX10-ILT is required.

Objective		DSX10-SXLOB	DSX10-XLOB	UIS2
Objective lens	Maximum sample height	50 mm	115 mm	145 mm
	Maximum sample height (free angle observation)	50 mm		
	Parfocal distance	140 mm	75 mm	45 mm
	Lens attachment	Integrated with lens	Available	
	Total magnification (on a 27-inch monitor, 1:1 display, at 100% image magnification)	27-1927x	58-7710x	34 ^{*4} -9637x
Actual F.O.V.	19,200 μ m-270 μ m	9,100 μ m-70 μ m	17,100 μ m-50 μ m	
Adapter	Diffusion adapter (option)	Available	Not available	
	Eliminate reflection adapter (option)	Available	Not available	
Lens attachment	Number of objectives that can be attached	Up to 1 piece (attachment is integrated with lens)	Up to 2 pieces	
Objective lens case		Three lens attachments can be stored		

*4 Total magnification when using MPLFLN1.25X

Stage		DSX10-RMTS	DSX10-MTS	U-SIC4R2
Stage	XY stage: motorized / manual	Motorized (with rotation function)	Motorized	Manual
	XY stroke	Stroke priority mode : 100 mm × 100 mm Rotation priority mode : 50 mm × 50 mm	100 × 100 mm	100 × 105 mm
	Rotation angle	Stroke priority mode : ±20° Rotation priority mode : ±90°	Not available	
	Display rotation angle	GUI	Not available	
	Load-resistance	5 kg (11 lb)		1 kg (2.2 lb)

Frame	DSX-UF	DSX-TF	Display	27-inch flat panel display
Z-axis stroke	50 mm (manual)		Resolution	1,920 (H) × 1,080 (V)
Tilt observation	Not available	±90°		
Tilt angle display	Not available	GUI		
Tilt angle method	Not available	Manual, fix / release handle		

System Total	Upright frame system	Tilt frame system
Weight (frame, head, motorized stage, display, and console)	43.7 kg (96.3 lb)	46.7 kg (103 lb)
Power consumption	100-120V / 220-240 V, 1.1 / 0.54A, 50 / 60Hz	

Dimensions

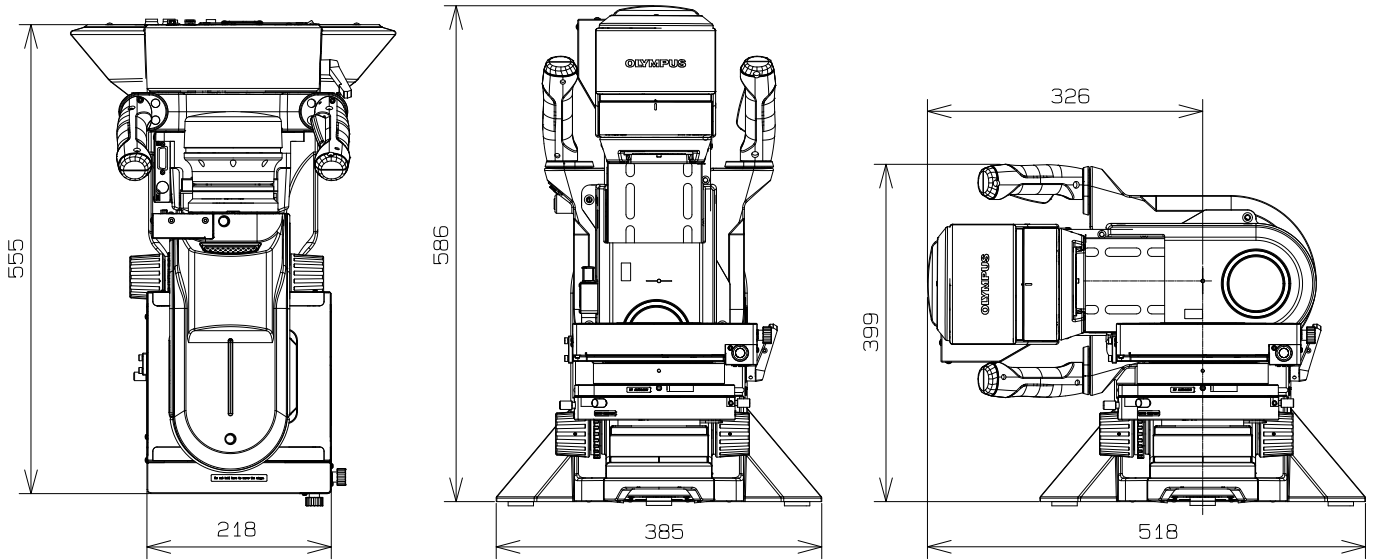

Customized Solutions

Expand Your Inspection Capabilities

The DSX1000 digital microscope's precision and ease of use make it a convenient choice for many industrial inspections, and its customization options provide even greater flexibility. Inspections are rarely standard, and a customized DSX1000 microscope can provide the capabilities you need for your application and workflow.

Beyond Standard

- Larger stages for big and heavy samples
- More space for tall samples without losing image quality
- Added observation modes, such as fluorescence
- And many other customization options



To learn how DSX1000 customized solutions can help you, get in touch:

www.olympus-ims.com/contact-us



Evident Corporation
Shinjuku Monolith, 2-3-1 Nishi-Shinjuku,
Shinjuku-ku, Tokyo 163-0910, Japan

EVIDENT CORPORATION is ISO14001 certified.
For details on certification registration, visit <https://www.olympus-ims.com/en/iso/>
EVIDENT CORPORATION is ISO9001 certified.
All company and product names are registered trademarks and/or trademarks of their respective owners. Performance characteristics and other values described in this brochure are based on our evaluations as of April 2024, and are subject to change without notice. The information including guaranteed accuracy in this brochure is based on the condition set by Evident. For details, refer to the Instruction Manual.
Images on the PC monitors are simulated.
Specifications and appearances are subject to change without any notice or obligation on the part of the manufacturer.