

# BX53M/BXFM System Microscope

## Advanced Microscopy Simplified

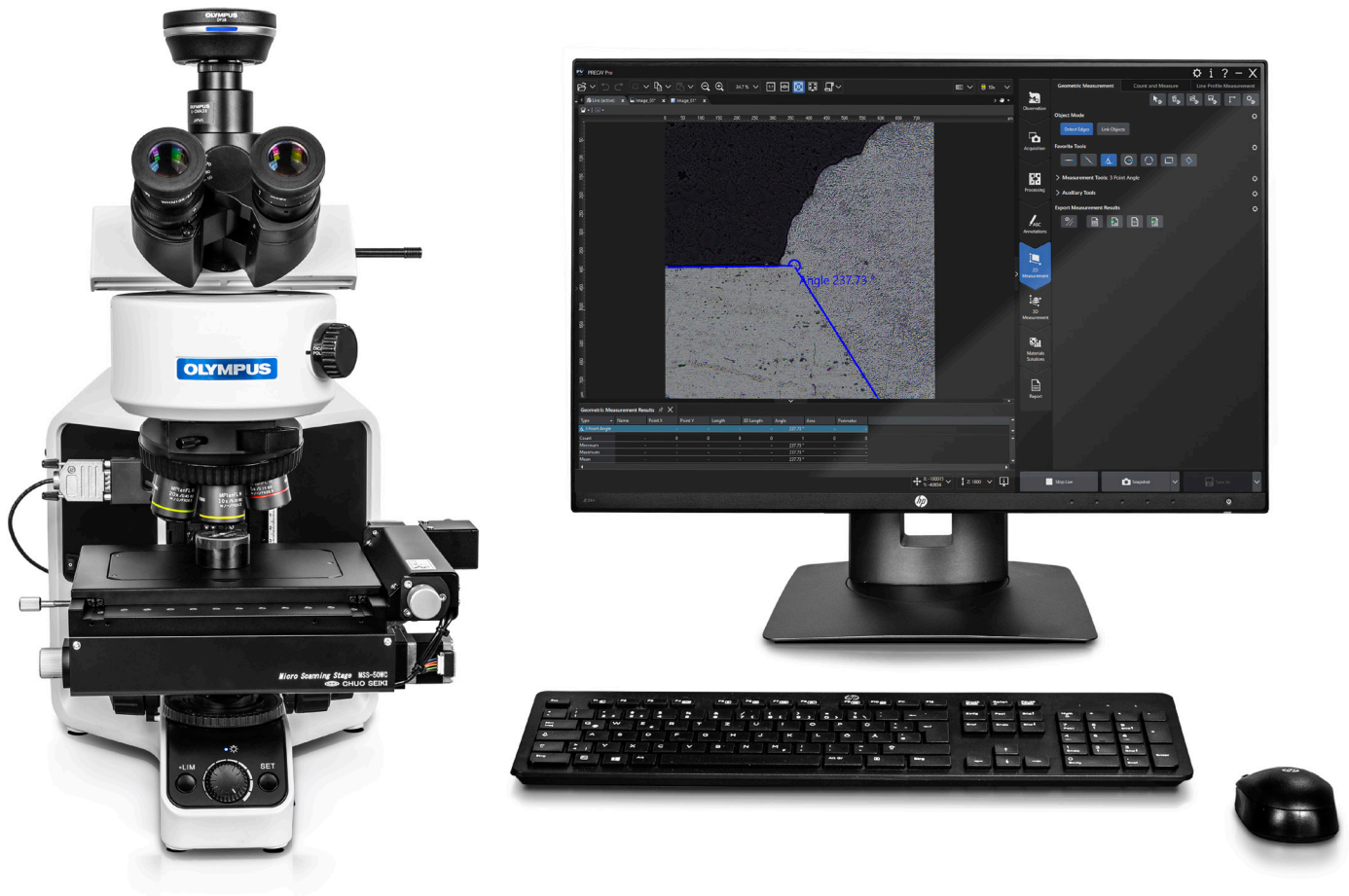

# Designed for Industrial and Materials Science Applications



Designed with modularity in mind, the BX3M series provide versatility for a wide variety of materials science and industrial applications. With improved integration with PRECiV™ software, the BX3M provides a seamless workflow for standard microscopy and digital imaging users from observation to report creation.

## Advanced Microscopy Simplified

### User-Friendly

---

Simplified and guided operation of the microscope settings makes it easier adjust and reproduce system settings.

### Functional

---

Designed for traditional industrial microscopy, the BX3M has expanded functionality to meet a broader range of applications and inspection techniques.

### Precision Optics

---

We have a long history of producing quality optics, providing superior images both in the eyepieces and on the monitor.

### Fully Customizable

---

Modular design gives you the flexibility to build a system that meets your specific needs.

# Intuitive Microscope Controls: Comfortable and Easy to Use

When performing inspection tasks, it often takes a long time to adjust the microscope settings, acquire the image, and make the necessary measurements to satisfy reporting requirements. You may need to invest time and money for professional microscope training, or work with limited knowledge about a microscope's full potential.

The BX3M microscope simplifies complex microscopy tasks through its well-designed and easy-to-use controls. You can get the most out of the microscope without the need for extensive training. The microscope's easy, comfortable operation also improves reproducibility by minimizing human error.

## Simple Illuminator: Traditional Techniques Made Easy

The illuminator minimizes complicated actions that are usually necessary during microscope operation. A dial at the front of the illuminator enables you to easily change the observation method. You can quickly switch between the most frequently used observation methods in reflected light microscopy, such as from brightfield to darkfield to polarized light, to readily change between different types of analyses. In addition, simple polarized light observation is adjustable by rotating the analyzer.

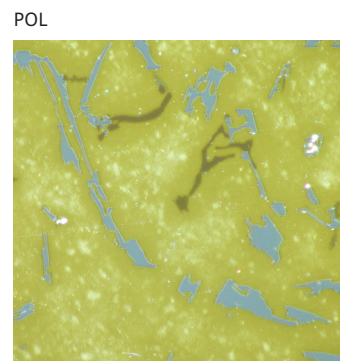
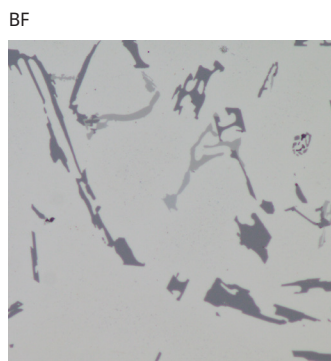

Polished sample of AISi

\*Requires DIC slider for use



## Intuitive Microscope Controls

Using the proper aperture stop and field stop settings provides good image contrast and makes full use of the objective's numerical aperture. The legend guides you to the correct setting based on the observation method and objective in use.

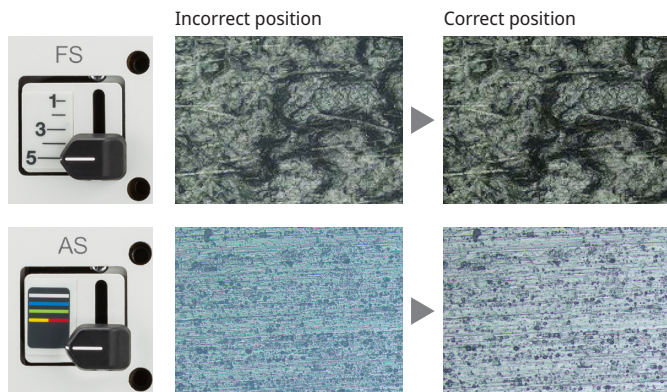

## Easily Restore Microscope Settings: Coded Hardware



Coded functions integrate the BX3M series' hardware settings with PRECiV™ image analysis software. The observation method, illumination intensity, and magnification are automatically recorded by the software and stored with the associated images. Since inspections can always be conducted with the same observation settings, it's easy to deliver reliable inspection results.

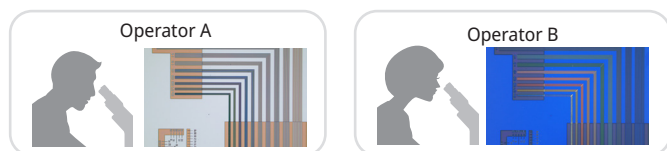

**X** Different operators use different settings.

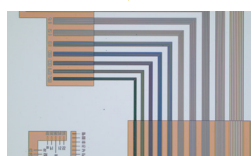
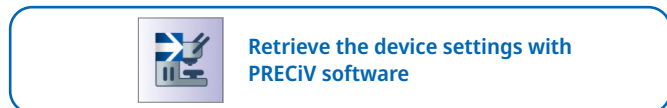

**✓** Different operators can use the same settings.

## Focus Scale Index: Find the Focus Quickly

The focus scale index on the frame supports quick access to the focal point. Operators can roughly adjust the focal point without viewing the sample through an eyepiece, saving time when inspecting samples that are different heights.



## Light Intensity Manager: Consistent Illumination

During the initial setup, the illumination intensity can be adjusted to match the specific hardware configuration of the coded illuminator and/or coded nosepiece.

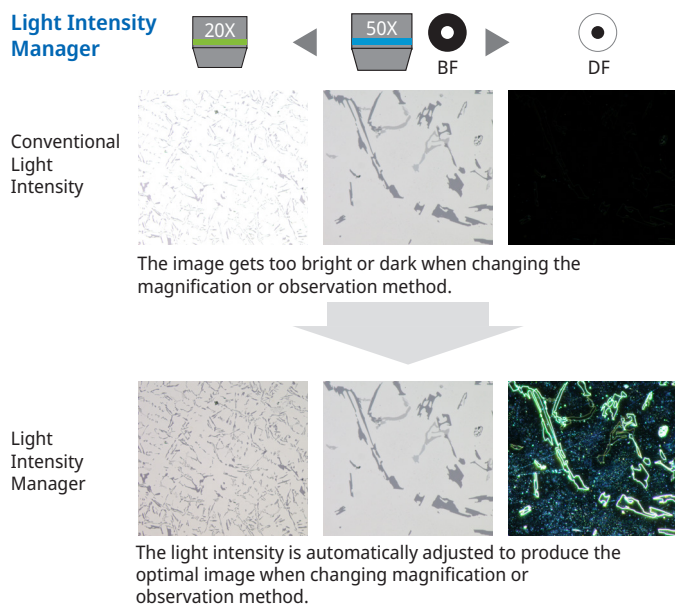

## Easy and Comfortable Operation

A system's design can affect your work efficiency. Both standalone microscope systems and those integrated with PRECiV image analysis software benefit from convenient handset controls that clearly display the hardware position. The simple handsets enable you to focus on the sample and the inspection they need to perform.

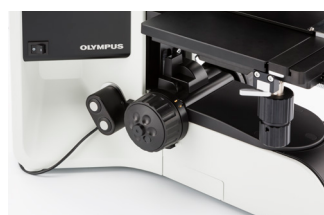

Hand switch for motorized nosepiece rotation



Hand switch

# Functionality for a Range of Inspection and Analytical Tasks

The BX3M series maintains traditional conventional microscopy contrast methods, such as brightfield, darkfield, polarized light, and differential interference contrast. As new materials are developed, many of the difficulties associated with detecting defects using standard contrast methods can be solved using advanced microscopy techniques for more accurate and reliable inspections. New illumination techniques and options for image acquisition within PRECIV image analysis software give you more choices of how to evaluate your samples and document findings. In addition, the BX3M microscope also accommodates larger-sized, heavier, and more specialized samples than conventional models.

## Advanced Imaging

### MIX Observation: The Invisible Becomes Visible

The BX3M series' MIX observation technology combines traditional illumination methods with darkfield illumination. When the MIX slider is used, its ring of LEDs shine directional darkfield on the sample. This has a similar effect to traditional darkfield, but provides the ability to select a quadrant of the LEDs to direct the light from different angles. This combination of directional darkfield and brightfield, fluorescence, or polarization is called MIX illumination and is especially helpful to highlight defects and differentiate raised surfaces from depressions.

#### Structure on a semiconductor wafer

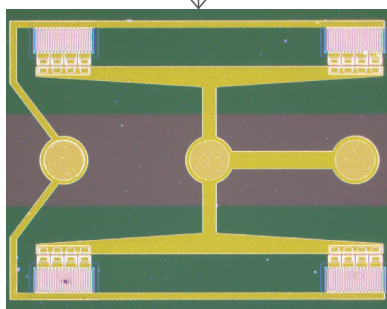
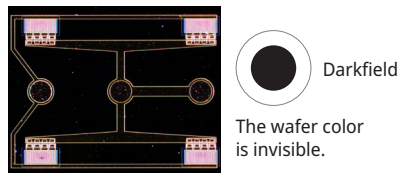
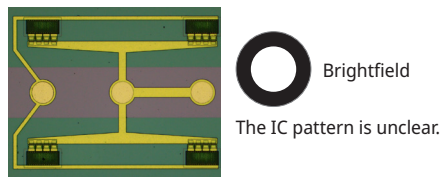

Both the wafer color and IC pattern are clearly represented.

#### Photoresist residue on a semiconductor wafer

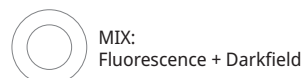
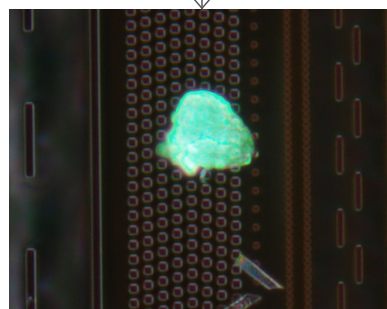
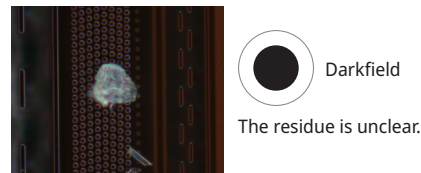
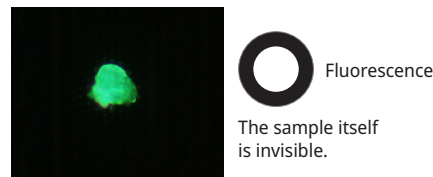

Both the IC pattern and residue are clearly represented.

#### Condenser

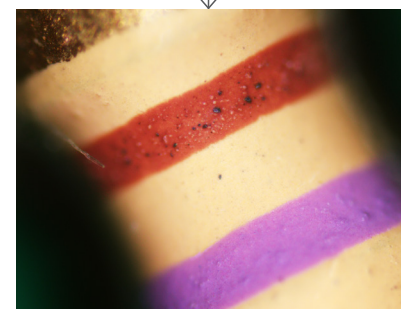
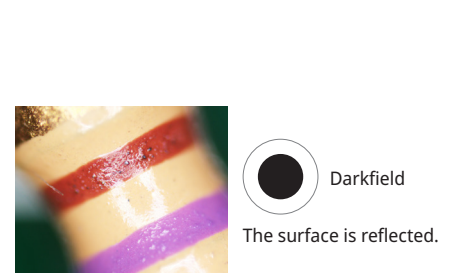

Composite image of several images with directional darkfield from different angles.

By stitching together clear images with no halation, a single crisp image of the sample is created.



## Instant Panorama: Easy Panoramic Imaging



You can now stitch images easily and quickly just by moving the XY knobs on the manual stage; no motorized stage is necessary. PRECiV™ software uses pattern recognition to generate a panoramic image giving users a wider field of view than a single frame.



Instant Panorama image of a coin

## EFI: Create All-in-Focus Images



The Extended Focus Imaging (EFI) function within PRECiV software captures images of samples whose height extends beyond the objective's depth of focus and stacks them together to create one image that is all in focus. EFI can be executed with either a manual or motorized Z-axis and creates a height map for easy structure visualization. It is also possible to construct an EFI image while offline within PRECiV Desktop.

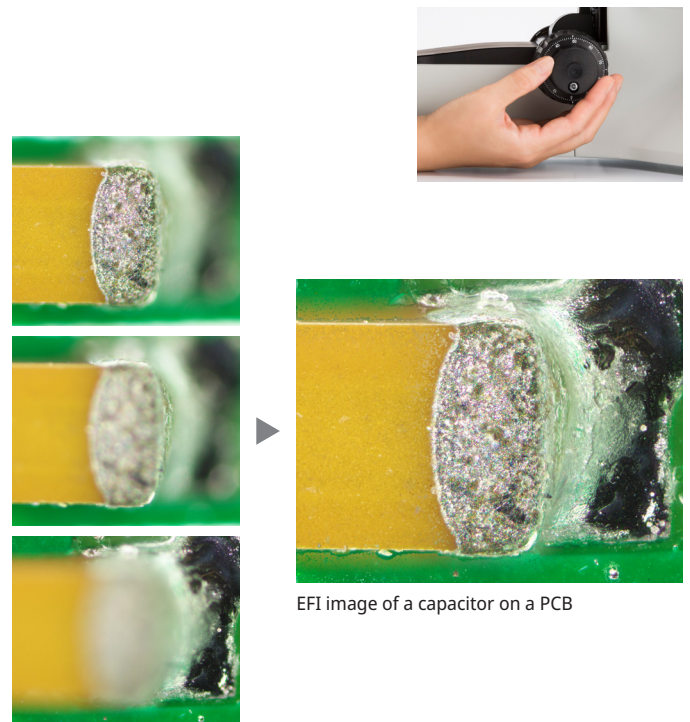

EFI image of a capacitor on a PCB

## HDR: Bright and Dark Areas



Using advanced image processing, high dynamic range (HDR) adjusts for differences in brightness within an image to reduce glare. HDR improves the visual quality of digital images, helping to generate professional-looking reports.

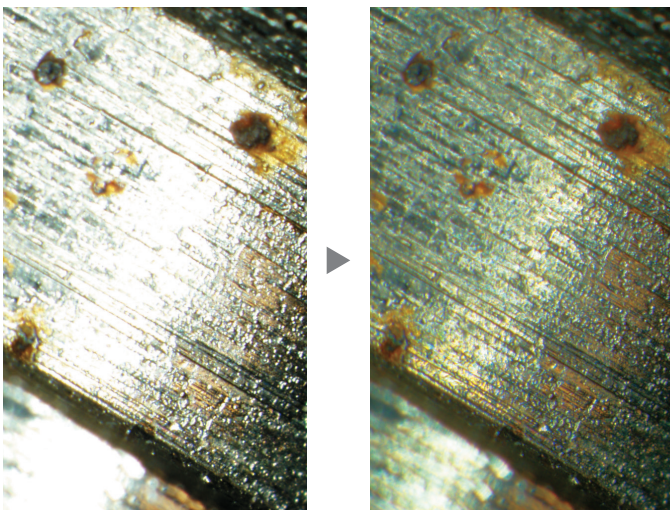

Clearly exposed for both dark and bright regions by HDR  
(Sample: Fuel injector bulb)

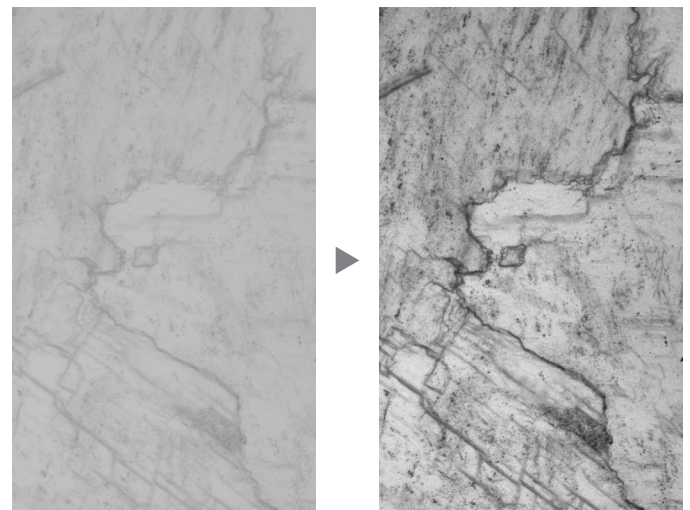

Contrast enhancement by HDR  
(Sample: Sliced magnesite)

# Advanced Measurement

## Routine or Basic Measurement

Various measurement functions are available through PRECiV software so that the user can easily obtain useful data from the images. For quality control and inspection, measuring features on images is often required. All levels of PRECiV licenses include interactive measurement functions such as distances, angles, rectangles, circles, ellipses, and polygons. All measured results are saved with the image files for further documentation.



## Count and Measure

Object detection and size distribution measurement are among the most important applications in digital imaging. PRECiV software incorporates a detection engine that utilizes threshold methods to reliably separate objects (e.g., particles, scratches) from the background.

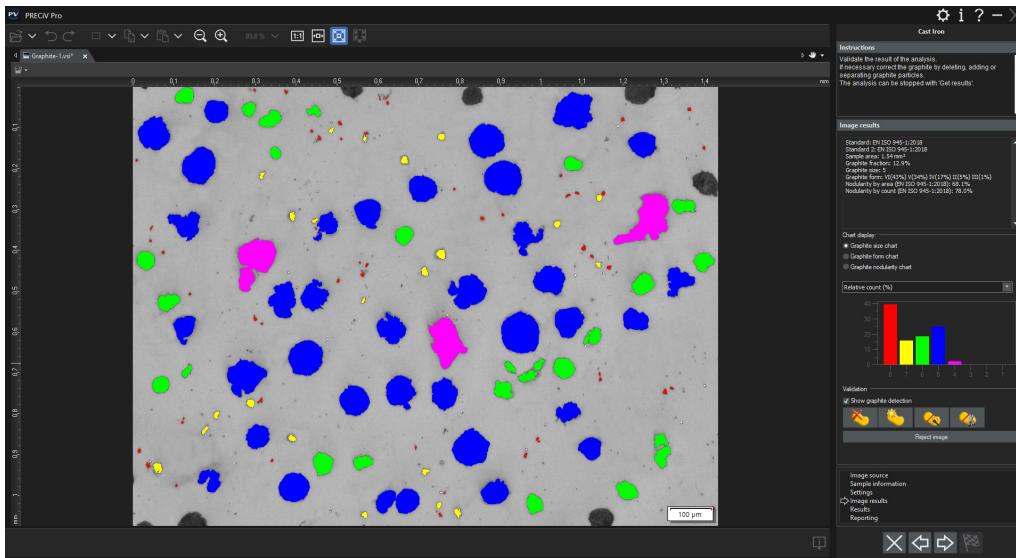

Count and Measure

## Materials Science Solutions

PRECiV™ offers an intuitive, workflow-oriented interface for complex image analysis. At the click of a button, complex image analysis tasks can be executed quickly, precisely, and in compliance with most common industrial standards. With a significant reduction in processing time for repeated tasks, material scientists can concentrate on analysis and research. Modular add-ins for inclusions and intercept charts are easily performed at any time.



## 3D Sample Measurement

When using an external coded or motorized focus drive, an EFI image can be quickly captured and displayed in 3D. The height data acquired can be used for 3D measurements on the profile or from the single view image.

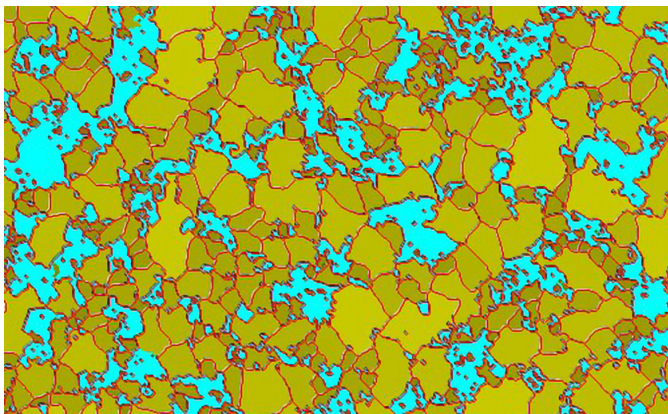

Grain sizing planimetric solution with secondary phase

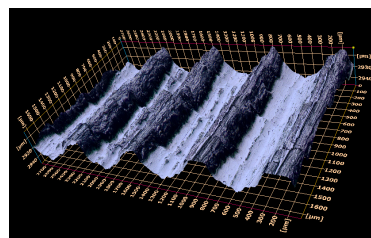

3D surface view (roughness test sample)

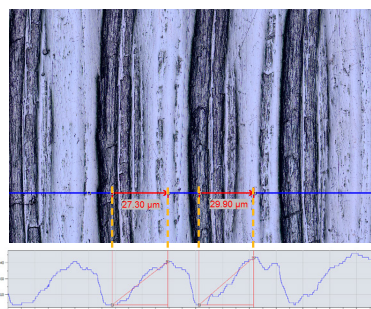

Single view and 3D profile measurement



## Advanced Sample Capacity

### View More Sample Types and Sizes

The 150 × 100 mm stage provides a longer travel in the X direction than previous models. This, together with the flat-top design, enables large samples or multiple samples to be easily placed on the stage. The stage plate has tapped holes to attach a sample holder. The larger stage provides flexibility to users by enabling them to inspect more samples on one microscope, saving valuable lab space. The stage's adjustable torque facilitates fine positioning under high magnification with a narrow field of view.

### Flexibility for Sample Height and Weight

Samples up to 105 mm (4.1 in.) can be mounted on the stage with the optional modular unit. Due to the improved focusing mechanism, the microscope can accommodate a total weight (sample + stage) of up to 6 kg (13.2 lb). This means that larger and heavier samples can be inspected on the BX3M microscope, so fewer microscopes are required in the lab. By strategically positioning a rotatable holder for 6-inch wafers off-center, users can observe the whole wafer surface by just rotating the holder when moving through the 100 mm travel range. The stage's torque adjustment is optimized for ease of use and the comfortable handle grip makes it easy to find the region of interest of the sample.



BX53MRF-S

### Flexibility for Sample Size

When samples are too large to place on a traditional microscope stage, the core optical components for reflected light microscopy can be arranged in a modular configuration. The BXFM modular system can be mounted on a larger stand via a pole or mounted to another instrument of choice using a mounting bracket. This enables users to take advantage of our renowned optics, even when their samples are unique in size or shape.



BXFM

## ESD Compatible: Protect Electronic Devices from Electrostatic Discharge

The BX3M has an ESD dissipation capability that protects electronic devices from static electricity caused by human or environmental factors.

# A History of Leading-Edge Optics

Our history of developing high-quality optics has resulted in a record of proven optical quality and microscopes that offer excellent measurement accuracy.

## Wavefront Aberration Control

When using a microscope for advanced research or system integration, optical performance must be standardized for all objectives. Our UIS2 objectives go beyond conventional numerical aperture (NA) and working distance (WD) performance standards by providing wavefront aberration control that minimizes the aberrations that lower resolution.

## Combined high numerical aperture and long working distance

Objective lenses are crucial to a microscope's performance. The MXPLFLN objectives add depth to the MPLFLN series for epi-illumination imaging by maximizing numerical aperture and working distance at the same time. Higher resolutions at 20X and 50X magnifications typically mean shorter working distances, which forces the sample or objective to be retracted during objective exchange. In many cases, the MXPLFLN series' 3 mm working distance eliminates this problem, enabling faster inspections with less chance of the objective hitting the sample.

## LED Illumination

The BX3M utilizes a high-intensity white LED light source for both reflected and transmitted light. The LED maintains a consistent color temperature regardless of intensity. LEDs provide efficient, long-life illumination that is ideal for inspecting materials science applications.

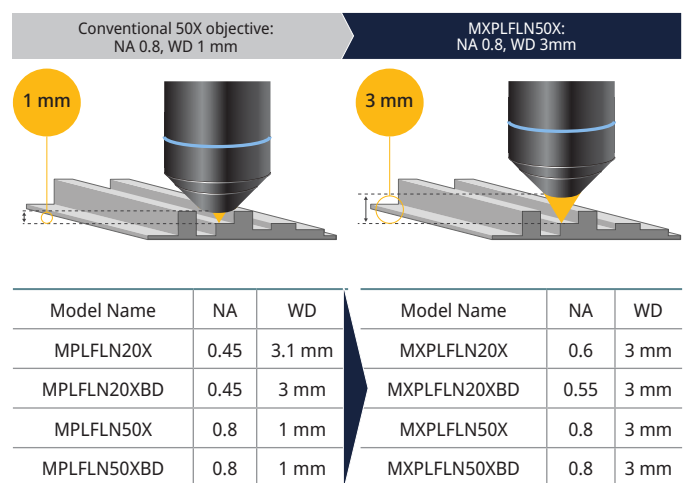

## Auto Calibration

Similar to digital microscopes, automatic calibration is available when using PRECiV™ software. Auto calibration eliminates human variability in the calibration process, leading to more reliable measurements. Auto calibration uses an algorithm that automatically calculates the correct calibration from an average of multiple measurement points. This minimizes variance introduced by different operators and maintains consistent accuracy, improving reliability for regular verification.

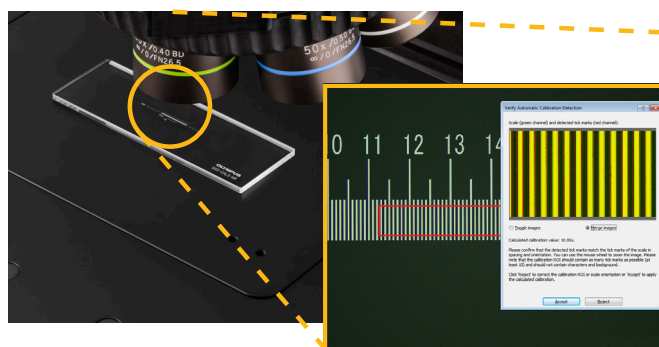

## Shading Correction

PRECiV software features shading correction to accommodate for shading around the corners of an image. When used with intensity threshold settings, shading correction provides a more precise analysis.



Semiconductor wafer (Binarized image)

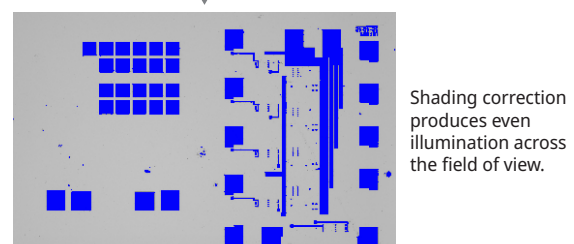
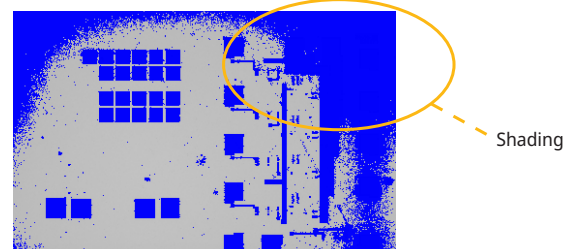

Shading correction produces even illumination across the field of view.

## Applications

Reflected light microscopy spans a range of applications and industries. These are just a selection of examples of what can be achieved using different observation methods.

### Darkfield / MIX with Brightfield IC pattern on a semiconductor wafer

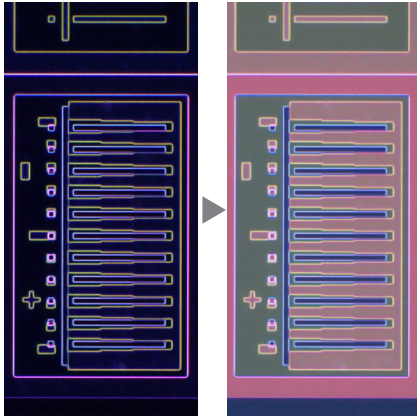

Darkfield

MIX with Brightfield

Darkfield is used to observe scattered or diffracted light from a sample. As only things that are not flat reflect this light, imperfections clearly stand out. Inspectors can identify even minute flaws. Darkfield is ideal for detecting minute scratches or flaws on a sample and examining mirror surface samples, including wafers.

- The MIX function of brightfield/darkfield enables the observation of both the IC pattern and wafer color.

### Fluorescence / MIX with Darkfield Photoresist residue on a semiconductor wafer

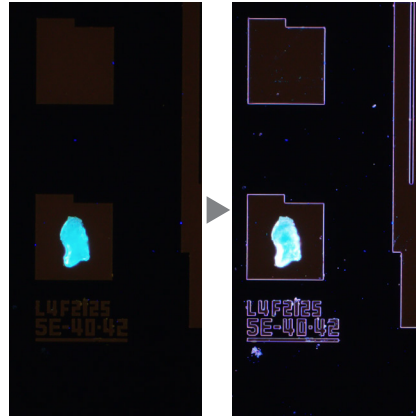

Fluorescence

MIX with Darkfield

This technique is used for samples that fluoresce (emit light of a different wavelength) when illuminated with a specially designed filter cube that can be selected to the specific application. It is used to inspect for contamination on semiconductor wafers, photoresist residues, and crack detection through the use of fluorescent dye.

- The MIX function of fluorescence/darkfield enables the observation of both the photoresist residue and IC pattern.

### Transmitted Light / MIX with Brightfield LCD color filter

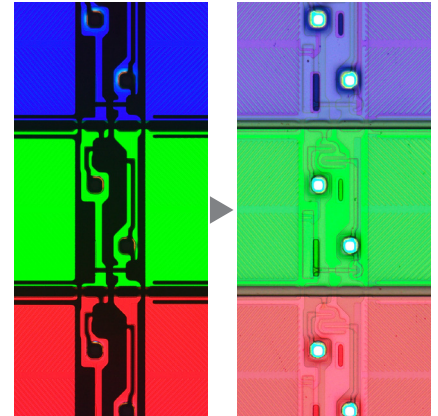

Transmitted Light

MIX with Brightfield

This observation technique is used for transparent samples such as LCDs, plastics, and glass materials.

- The MIX function of brightfield/transmitted light enables the observation of both the filter color and circuit pattern.

### Spheroidal graphite cast iron

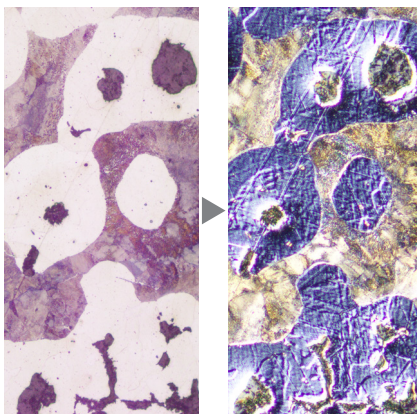

Brightfield

Differential Interference Contrast

Differential interference contrast (DIC) is an observation technique where the height of a sample, normally not detectable in brightfield, is visible as a relief, similar to a 3D image with improved contrast. It is ideal for inspections of samples that have very minute height differences, including metallurgical structures and minerals.

### Sericite

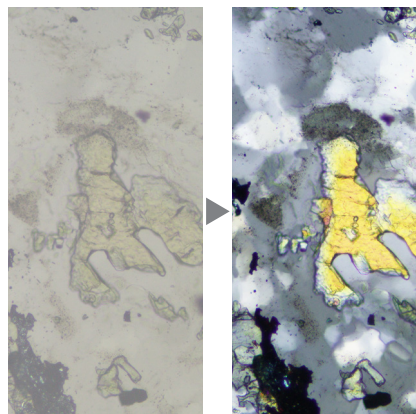

Brightfield

Polarized Light

This microscopic observation technique utilizes polarized light generated by a set of filters (analyzer and polarizer). The characteristics of the sample directly affect the intensity of the light reflected through the system. It is used for metallurgical structures (i.e., growth pattern of graphite on nodular casting iron), minerals, LCDs, and semiconductor materials.

### Electrode section

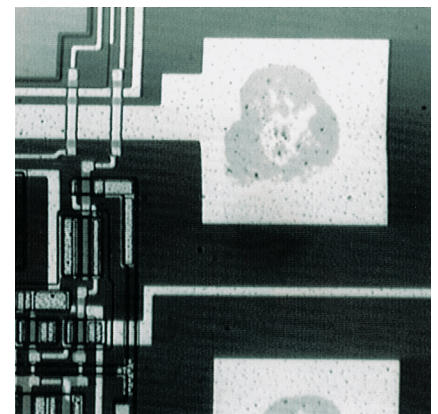



Infrared (IR)

IR observation is used for nondestructive inspections of defects inside IC chips and other electronic devices constructed with silicon or glass that easily transmit IR wavelengths of light.

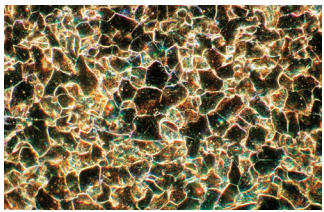

## Choose the Configuration for Your Needs

Six BX53M suggested configurations provide the flexibility to select the system that best meets your needs.

		General use	
		Entry	Standard
		Easy set up with basic features	Simple to use with versatile upgrades
			
		LCD color filter (Transmitted/BF)	Microstructure with ferritic grains (Reflected/DF)
			

: Standard  
: Option

Microscope frame		Reflected or Reflected / Transmitted	
<b>Observation method</b> R-BF :Brightfield (Reflected) T-BF :Brightfield (Reflected/Transmitted) DF :Darkfield DIC :Differential interference contrast/Simple polarization MIX :MIX FL :Fluorescence IR :Infrared POL :Polalization * T-BF can be used when selecting a "Refrected/Transmitted microscope frame.	Standard	<input checked="" type="checkbox"/> R-BF <input checked="" type="checkbox"/> T-BF	<input checked="" type="checkbox"/> R-BF <input checked="" type="checkbox"/> T-BF <input checked="" type="checkbox"/> DF
	Option	<input type="checkbox"/> DIC	<input type="checkbox"/> DIC <input type="checkbox"/> MIX
Simple illuminator to readily change analysis type		–	<input checked="" type="checkbox"/>
Aperture legend to support correct AS/FS setting		–	<input checked="" type="checkbox"/>
Coded hardware to easily restore setting		–	<input checked="" type="checkbox"/>
Focus scale index to find the focus quickly		<input checked="" type="checkbox"/>	<input checked="" type="checkbox"/>
Light intensity manager for consistent illumination		<input checked="" type="checkbox"/>	<input checked="" type="checkbox"/>
Easy and comfortable hand switch operation		<input type="checkbox"/>	<input type="checkbox"/>
MIX observation to make invisible visible		<input type="checkbox"/>	<input type="checkbox"/>
Objectives	*For details, please refer to the specification table on page 25.	Select from 3 sets of objective grades based on your applications	
Stage		Select from 5 stages based on the size of your samples	



## Advanced

Supports numerous advanced unique features

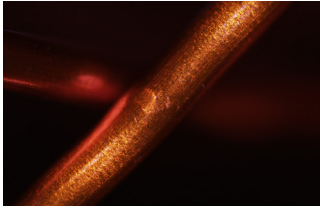

Copper wire of coil (BF+DF/MIX)

## Dedicated use

### Fluorescence

Ideally suited for fluorescence observation

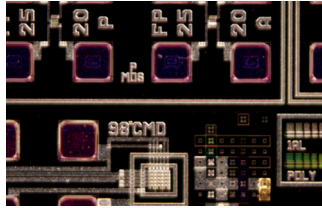

Resist on the IC pattern (FL+DF/MIX)

### Infrared

Designed to use infrared observation to inspect integrated circuits

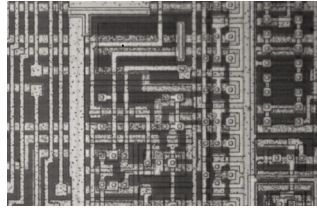

"Silicon layering IC pattern (IR)"

### Polarization

Designed for observing birefringence characteristics

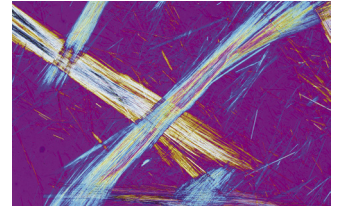

Asbestos (POL)



Reflected or Reflected / Transmitted		Reflected		Transmitted	
R-BF	T-BF	R-BF	T-BF	R-BF	IR
DF	MIX	DF	FL	T-BF	POL
DIC	MIX	DIC	-	-	-
■	-	-	-	-	-
■	■	-	-	■	■
■	■	-	-	■	■
■	■	■	-	■	■
■	-	-	-	■	■
■	□	-	-	-	-
■	□	-	-	-	-
Select from 3 sets of objective grades based on your applications		Objectives for IR		Objectives for POL	
Select from 5 stages based on the size of your samples				Stage for POL	

## Example Configurations for Materials Science

### BX53M Reflected and Reflected/Transmitted Light Combination

There are two types of microscope frames in the BX3M series, one for reflected light only and one for both reflected and transmitted light. Both frames can be configured with manual, coded, or motorized components. The frames are outfitted with ESD capability to protect electronic samples.



BX53MRF-S example configuration



BX53MTRF-S example configuration

### BX53M IR Combination

IR objectives can be used for semiconductor inspection, measurement, and processing applications where imaging through silicon is required to see the pattern. 5X to 100X infrared (IR) objectives are available with chromatic aberration correction from visible light wavelengths through the near infrared. For high-magnification work, rotating the correction collar of the LCPLN-IR series of lenses corrects for aberrations caused by sample thickness. A clear image is obtained with a single objective.

Objectives	Magnifications	NA	W.D. (mm)	Cover Glass Thickness (mm)	Silicon Thickness (mm)	Resolution*1 (μm)
LMPLN-IR*2	5X	0.10	23	0-0.17	—	6.71 <sup>*3</sup>
	10X	0.30	18	0-0.17	—	2.24 <sup>*3</sup>
LCPLN-IR*2	20X	0.45	8.3	0-1.2	0-1.2	1.49 <sup>*3</sup>
	50X	0.65	4.5	0-1.2	0-1.2	1.03 <sup>*3</sup>
	100X	0.85	1.2	0-0.7	0-1.0	0.79 <sup>*3</sup>

\*1 Resolutions calculated with aperture iris diaphragm wide open

\*2 Limited up to FN 22, not compatible with FN 26.5

\*3 With the use of 1100 nm



IR objectives

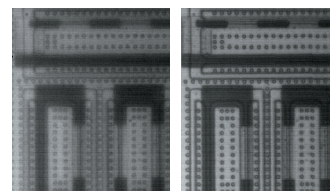

Without correction corrected

## BX53M Polarized Light Combination

The optics of the BX53M polarized light provide geologists with the right tools for high-contrast polarized light imaging. Applications such as mineral identification, investigating the optical characteristics of crystals, and observing solid rock sections benefit from system stability and precise optical alignment.

## Bertrand Lens for Conoscopic and Orthoscopic Observations

With a U-CPA conoscopic observation attachment, switching between orthoscopic and conoscopic observation is simple and fast. It is focusable for clear back focal plane interference patterns. The Bertrand field stop makes it possible to obtain consistently sharp and clear conoscopic images.



Polarized light accessories

## Strain-Free Optics

Thanks to our sophisticated design and manufacturing technology, the UPLFLN-P strain-free objectives reduce internal strain to the minimum. This means a higher EF value, resulting in excellent image contrast.



UPLFLN-P strain-free objectives

### UPLFLN-P series

Objectives	NA	W.D.
UPLFLN 4XP	0.13	17.0 mm
UPLFLN 10XP	0.30	10.0 mm
UPLFLN 20XP	0.50	2.1 mm
UPLFLN 40XP	0.75	0.51 mm
UPLFLN 100XOP	1.30	0.2 mm

### PLN-P\*

Objectives	NA	W.D.
PLN 4XP	0.10	18.5 mm

### ACHN-P series\*

Objectives	NA	W.D.
ACHN 10XP	0.25	6.0 mm
ACHN 20XP	0.40	3.0 mm
ACHN 40XP	0.65	0.45 mm
ACHN 100XOP	1.25	0.13 mm

\*Limited up to FN 22, not compatible with FN 26.5

## BXFM System

The BXFM system can be adapted to special applications or integrated into other instruments. The modular construction provides for straightforward adaptation to unique environments and configurations with a variety of special small illuminators and fixturing mounts.



BX53M orthoscopic configuration



BX53M conoscopic/  
orthoscopic configuration

## An Extensive Range of Compensator and Wave Plates

Five different compensators are available to measure birefringence in rock and mineral thin sections. Measurement retardation level ranges from 0 to  $20\lambda$ . For easier measurement and high image contrast, the Berek and Senarmont compensators can be used, which change the retardation level in the entire field of view.



### Measuring range of compensators

Compensator	Measurement Range	Applications
Thick Berek (U-CTB)	0/11000 nm (20 $\lambda$ )	Measurement of high retardation level ( $R^* > 3\lambda$ ), (crystals, macromolecules, fiber, etc.)
Berek (U-CBE)	0/1640 nm (3 $\lambda$ )	Measurement of retardation level (crystals, macromolecules, living organisms, etc.)
Senarmont Compensator (U-CSE)	0/546 nm (1 $\lambda$ )	Measurement of retardation level (crystals, living organisms, etc.) Enhancement of Image Contrast (living organisms, etc.)
Brace-Koehler Compensator 1/30 $\lambda$ (U-CBE2)	0/20 nm (1/30 $\lambda$ )	Measurement of image contrast (living organisms, etc.)
Quartz Wedge (U-CWE2)	500/2200 nm (4 $\lambda$ )	Approximate measurement of retardation level (crystal, macromolecules, etc.)

\*R = retardation level

For more accurate measurement, it is recommended that compensators (except U-CWE2) be used together with the interference filter 45-IF546





# Modular Design: Build Your System Your Way

## Microscope Frames

There are two microscope frames for reflected light; one also has transmitted light capability. An adaptor is available to raise the illuminator to accommodate taller samples.

	■: Possible	Reflected light	Transmitted light	Sample height
1		■		0-65 mm
2		■	■	0-35 mm
1, 3		■		40-105 mm
2, 3		■	■	40-75 mm

Convenient accessories for microscopy use.

-	HP-2	Hand press
-	COVER-018	Dust cover



## Stands

For microscopy applications where the sample will not fit on a stage, the illuminator and optics can be mounted on a larger stand or to another piece of equipment.

BXFM + BX53M illuminator configuration

1	BXFM-F	Frame interface is wall mounting/32 mm pillar
2	BX3M-ILH	Illuminator holder
3	BXFM-ILHSPU	Counter spring for BXFM
6	SZ-STL	Large stand

BXFM + U-KMAS illuminator configuration

1	BXFM-F	Frame interface is wall mounting/32 mm pillar
4	BXFM-ILHS	U-KMAS holder
5	SZ-STL	Large stand



## Tubes

For microscope imaging with eyepieces or for camera observation, select tubes by imaging type and operator's posture during observation.

	FN	Type	Angle type	Image	Number of diopter adjustment mechanisms
1	22	Trinocular	Fixing	Reverse	1
2	22	Trinocular for IR	Fixing	Reverse	1
3	22	Trinocular	Fixing	Erect	—
4	22	Trinocular	Tilting	Reverse	—
5	26.5	Trinocular	Fixing	Reverse	—
6	26.5	Trinocular	Tilting	Erect	—
7	22	Single port	—	—	—
8	26.5	Single port	—	—	—





## Illuminators

The illuminator projects light onto the sample based on the observation method selected. Software interfaces with coded illuminators to read the cube position and automatically recognize the observation method.



	█: Possible	Coded function	Light source	BF	DF	DIC	POL	IR	FL	MIX	AS/FS
1	BX3M-RLAS-S	Fixed 3 cube position	LED - built in	█	█	█	█			█	█
2	BX3M-URAS-S	Attachable 4 cube position	LED	█	█	█	█			█	█
			Halogen lamp	█	█	█	█	█	█	█	█
			Mercury/Light guide	█	█	█	█		█	█	█
3	BX3M-RLA-S		LED	█	█	█	█			█	█
			Halogen lamp	█	█	█	█	█	█	█	█
4	BX3M-KMA-S		LED - built in	█		█	█			█	
5	BX3-ARM	Mechanical arm for transmitted light									
6	U-KMAS		LED	█		█	█			█	
			Halogen lamp	█		█	█	█	█	█	

## Light Sources

Light sources and power supplies for sample illumination: choose the appropriate light source for the observation method.

### Standard LED light source configuration

1	BX3M-LEDR	LED lamp housing for reflected light
2	U-RCV	DF converter for BX3M-URAS-S, required for observation with DF when necessary
3	BX3M-PSLED	Power supply for LED lamp housing, requires BXFM system
4	BX3M-LEDT	LED lamp housing for transmitted light

### Fluorescence light source configuration

5	U-LLGAD	Light guide adaptor
2	U-RCV	DF converter for BX3M-URAS-S, required for observation with DF when necessary
6	U-LLG150	Light guide, length:1.5 m (4.9 ft)
7	U-LGPS	Light source for fluorescence
8, 9	U-LH100HG(HGAPO)	Mercury lamp housing for fluorescence
2	U-RCV	DF converter for BX3M-URAS-S, required for observation with DF when necessary
10	U-RFL-T	Power supply for 100 W mercury lamp

### Halogen lamp and halogen lamp IR light source configuration

11	U-LH100IR	Halogen lamp housing for IR
12	U-RMT	Extender cable for halogen lamp housing, cable length 1.7 m (5.6 ft) (requires cable extension when necessary)
13, 14	TH4-100 (200)	100 V (200 V) specification power supply for 100 W/50 W halogen lamp
15	TH4-HS	Hand switch for light intensity of halogen lamp (dimmer TH4-100 (200) without hand switch)



## Nosepieces

Attachment for objectives and sliders. Select by the number of objectives needed and types; also with/without slider attachment.

	■ Possible	Type	Holes	BF	DF	DIC	MIX	ESD	Number of centering holes
1		Manual	4	■		■			4
2		Manual	5	■					
3		Coded	5	■				■	
4		Manual	6	■		■			
5		Coded	6	■		■			
6		Motorized	5	■	■	■	■		
7		Manual	6	■	■	■	■		
8		Coded	5	■	■	■	■	■	
9		Coded	6	■	■	■	■	■	
10		Motorized	6	■		■			
11		Motorized	6	■	■	■	■	■	
12		Motorized	5	■	■				



## Sliders

Select the slider to complement traditional brightfield observation. The DIC slider provides topographic information about the sample with options to maximize contrast or resolution. The MIX slider provides illumination flexibility with a segmented LED source in the darkfield path.

### DIC slider

	Type	Amount of shear	Available objectives
1	U-DICR	Standard	MPLFLN*, MPLFLN-BD**, LMPLFLN, LMPLFLN-BD, MXPLFLN, MXPLFLN-BD, MPLAPON, LCPLFLN-LCD

### MIX slider

	Available objectives
2	MPLFLN-BD, LMPLFLN-BD, MPLN-BD, MXPLFLN-BD

### Cable

-	U-MIXRCBL-1-2***	U-MIXR cable, cable length: 0.5 m (1.6 ft)
---	------------------	--

\*1.25X and 2.5X are not available. \*\*2.5X is not available. \*\*\*MIXR only



## Control Boxes and Hand Switches

Control boxes for interfacing microscope hardware with a PC and hand switches for hardware display and control.

### BX3M-CB (CBFM) configuration

1	BX3M-CB	Control box for BX53M system
2	BX3M-CBFM	Control box for BXFM system
3	BX3M-HS	MIX observation control, indicator of coded hardware, programmable function button of software (PRECIV)
4	BX3M-HSRE	Motorized nosepiece rotation

### Cable

-	BX3M-RMCBL	Motorized nosepiece cable, cable length: 0.2 m (0.7 ft)
---	------------	---



## Stages

Stages and stage plates for sample placement. Select based on sample shape and size.

### 150 mm × 100 mm stage configuration

1	U-SIC64	150 mm × 100 mm flat top handle stage
2	U-SHG (T)	Silicone rubber operability handle rubber for improvement (thick type)
3	U-SP64	Stage plate for U-SIC64
4	U-WHP64	Wafer plate for U-SIC64
5	BH2-WHR43	Wafer holder for 4-3 in.
6	BH2-WHR65	Wafer holder for 6-5 in.
7	U-SPG64	Glass plate for U-SIC64

### 100 mm × 100 mm stage configuration

8	U-SICR2	105 mm × 100 mm right handle stage
9	U-MSSP4	Stage plate for U-SIC4R2
10	U-WHP2	Wafer plate for U-SIC4R2
5	BH2-WHR43	Wafer holder for 4-3 in.
11	U-MSSPG	Glass plate for U-SIC4R2

### 76 mm × 52 mm stage configuration

12	U-SVRM	76 mm × 52 mm right handle stage
2	U-SHG (T)	Silicone rubber operability handle rubber for improvement (thick type)
13	U-MSSP	Stage plate for U-SVR M
14, 15	U-HR (L) D-4	Thin slide holder for the right (left) opening
16, 17	U-HR (L) DT-4	Thick slide holder for the right (left) opening, for pressing the slide glass to stage top surface, when the specimen is difficult to lift

### Other

18	U-SRG2	Rotatable stage
19	U-SRP	Rotatable stage for POL, from any position can be 45° click stop
20	U-FMP	Mechanical stage for U-SRP/U-SRG2



## Camera Adaptors

Adaptors for camera observation. Selectable from required field of view and magnification. Actual observation range can be calculated using this formula: actual field of view (diagonal mm) = viewing field (viewing number) ÷ objective magnification.

		Magnification	Centering adjustment (mm)	CCD image area (field number) (mm)		
				2/3 in.	1/1.8 in.	1/2 in.
1	U-TV1X-2 with U-CMAD3	1	—	10.7	8.8	8
2	U-TV1XC	1	ø2	10.7	8.8	8
3	U-TV0.63XC	0.63	—	17	14	12.7
4	U-TV0.5XC-3	0.5	—	21.4	17.6	16
5	U-TV0.35XC-2	0.35	—	—	—	22

For information on digital cameras, please visit our website at <http://www.olympus-ims.com/en/microscope/dc/>



## Eyepieces

Eyepiece for viewing directly into the microscope. Select based on desired field of view.

	■: Possible	FN (mm)	Diopter adjustment mechanism	Built-in cross reticle
1		22		
2		22	■	
3		22	■	■
4		26.5	■	
5		26.5	■	■



## Optical Filters

Optics filters convert sample exposure light to various types of illumination. Select the appropriate filter for observation requirements.

### BF, DF, FL

1, 2	U-25ND25, 6	Neutral density filter, transmittance 25%, 6%
3	U-25LBD	Daylight color filter
4	U-25LBA	Halogen lamp color filter
5	U-25IF550	Green filter
6	U-25L42	UV-cut filter
7	U-25Y48	Yellow filter
8	U-25FR	Frost filter (required for the BX3M-URAS-S)

### POL, DIC

9	U-AN-2	Polarization direction is fixed
10	U-AN360-3	Polarization direction is rotatable
11	U-AN360P-2	High-quality polarization direction is rotatable
12	U-PO3	Polarization direction is fixed
13	45-IF546	Green ø45 mm filter for POL

### Other

20	U-25	Empty filter, for use with user's ø25 mm filters
----	------	--



### IR

14	U-AN360IR	IR polarization direction is rotatable (reduces halation at IR observation when using combination with U-AN360IR and U-POIR)
15	U-POIR	IR polarization direction is fixed
16	U-BP1100IR	Band pass filter: 1100 nm
17	U-BP1200IR	Band pass filter: 1200 nm

### Transmitted light

18	43IF550-W45	Green ø45 mm filter
19	U-POT	Polarizer filter

● AN and PO are not necessary when using BX3M-RLAS-S and U-FDICR

## Condensers

Condensers collect and focus transmitted light. Use for transmitted light observation.

1	U-AC2	Abbe condenser (available for 5X objectives and above)
2	U-SC3	Swing-out condenser (available for 1.25X objectives and above)
3	U-LWCD	Long working distance condenser for glass plates (U-MSSPG, U-SPG64)
4	U-POC-2	Swing-out condenser for POL



## Mirror Units

Mirror unit for BX3M-URAS-S. Select the unit for required observation.

1	U-FBF	For BF, detachable ND filter
2	U-FDF	For DF
3	U-FDICR	For POL, crossed nicol position is fixed
4	U-FBFL	For BF, built-in ND filter (it is necessary to use both BF* and FL)
5	U-FWUS	For Ultra Violet-FL: BP330-385 BA420 DM400
6	U-FWBS	For Blue-FL: BP460-490 BA520IF DM500
7	U-FWGS	For Green-FL: BP510-550 BA590 DM570
8	U-FF	Empty mirror unit

\*For coaxial episcopic illumination only



## Intermediate Tubes

Various types of accessories for multiple purposes. For use between tube and illuminator.

1	U-CA	Magnification changer (1X, 1.25X, 1.6X, 2X)
2	U-TRU	Trinocular intermediate unit

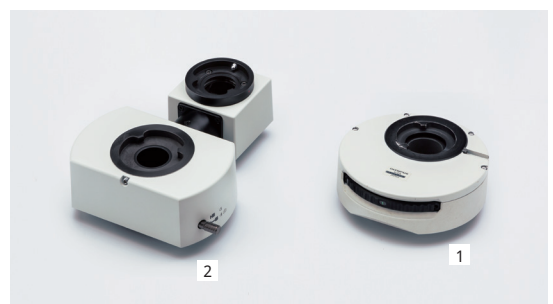



## UIS2 Objectives

Objectives magnify the sample. Select the objective that matches the working distance, resolving power, and observation method for the application.

Objectives		Magnifications	NA	W.D. (mm)	Cover Glass Thickness <sup>3</sup> (mm)	Resolution <sup>4</sup> (µm)
MPLAPON	1	50X	0.95	0.35	0	0.35
	2	100X	0.95	0.35	0	0.35
MXPLFLN	3	20X	0.6	3	0	0.56
	4	50X	0.8	3	0	0.42
MPLFLN	5	1.25X <sup>2,5,6</sup>	0.04	3.5	0/0.17	8.39
	6	2.5X <sup>2,6</sup>	0.08	10.7	0/0.17	4.19
	7	5X	0.15	20.0	0/0.17	2.24
	8	10X	0.30	11.0	0/0.17	1.12
	9	20X	0.45	3.1	0	0.75
	10	40X <sup>2</sup>	0.75	0.63	0	0.45
	11	50X	0.80	1.0	0	0.42
SLMPLN	13	20X	0.25	25	0/0.17	1.34
	14	50X	0.35	18	0	0.96
	15	100X	0.60	7.6	0	0.56
LMPLFLN	16	5X	0.13	22.5	0/0.17	2.58
	17	10X	0.25	21.0	0/0.17	1.34
	18	20X	0.40	12.0	0	0.84
	19	50X	0.50	10.6	0	0.67
	20	100X	0.80	3.4	0	0.42
MPLN <sup>5</sup>	21	5X	0.10	20.0	0/0.17	3.36
	22	10X	0.25	10.6	0/0.17	1.34
	23	20X	0.40	1.3	0	0.84
	24	50X	0.75	0.38	0	0.45
	25	100X	0.90	0.21	0	0.37
LCPLFLN/LCD	26	20X	0.45	8.3/7.4	0/1.2	0.75
	27	50X	0.70	3.0/2.2	0/1.2	0.48
	28	100X	0.85	1.2/0.9	0/0.7	0.39
MXPLFLN-BD	29	20X	0.55	3	0	0.61
	30	50X	0.80	3	0	0.42
MPLFLN/BD <sup>7</sup>	31	2.5X <sup>2</sup>	0.08	8.7	-	4.19
	32	5X	0.15	12.0	0/0.17	2.24
	33	10X	0.30	6.5	0/0.17	1.12
	34	20X	0.45	3.0	0	0.75
	35	50X	0.80	1.0	0	0.42
	36	100X	0.90	1.0	0	0.37
	37	150X	0.90	1.0	0	0.37
LMPLFLN/BD <sup>7</sup>	38	5X	0.13	15.0	0/0.17	2.58
	39	10X	0.25	10.0	0/0.17	1.34
	40	20X	0.40	12.0	0	0.84
	41	50X	0.50	10.6	0	0.67
	42	100X	0.80	3.3	0	0.42
MPLN/BD <sup>5,7,8</sup>	43	5X	0.10	12.0	0/0.17	3.36
	44	10X	0.25	6.5	0/0.17	1.34
	45	20X	0.40	1.3	0	0.84
	46	50X	0.75	0.38	0	0.45
	47	100X	0.90	0.21	0	0.37
MPLAPON2		100XOil <sup>1</sup>	1.45	0.1	0	0.23



\*1 Specified oil: IMMOIL-F30CC/IMMOIL-8CC/IMMOIL-500CC/IMMOIL-F30CC

\*2 The MPLFLN1.25X, 2.5X, 40X and MPLFLN/BD2.5X objectives are not compatible with the differential interference contrast microscopy

\*3 0: For viewing specimens without a cover glass

\*4 Resolutions calculated with aperture iris diaphragm wide open

\*5 Limited up to FN 22, no compliance with FN 26.5

\*6 Analyzer and polarizer are recommended for usage with MPLFLN1.25X and 2.5X

\*7 BD: Brightfield/Darkfield objectives

\*8 Slight vignetting may occur in the periphery of the field when MPLN-BD series objectives are used with high-intensity light sources such as mercury and xenon for darkfield observation

### ■ Definition for Objective Lens Abbreviations

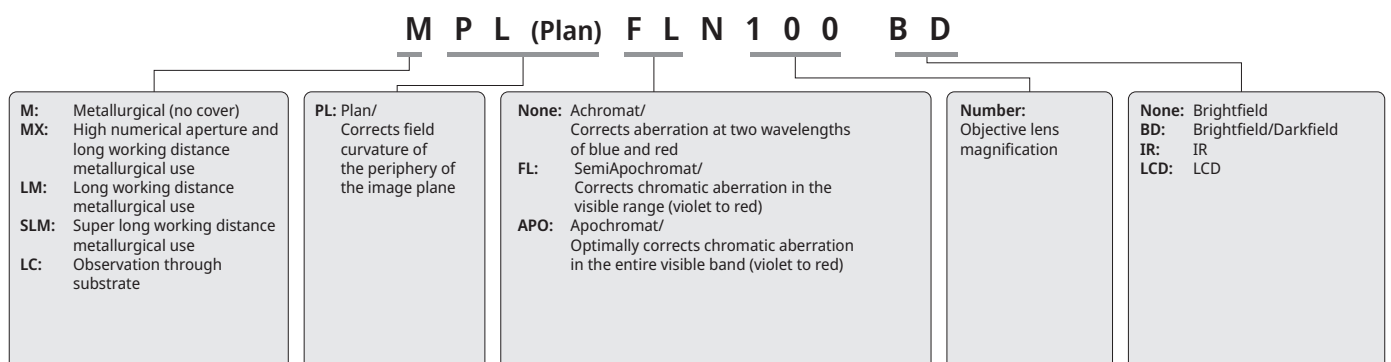

# BX53M System Diagram (for Reflected and Reflected/Transmitted Light Combination)

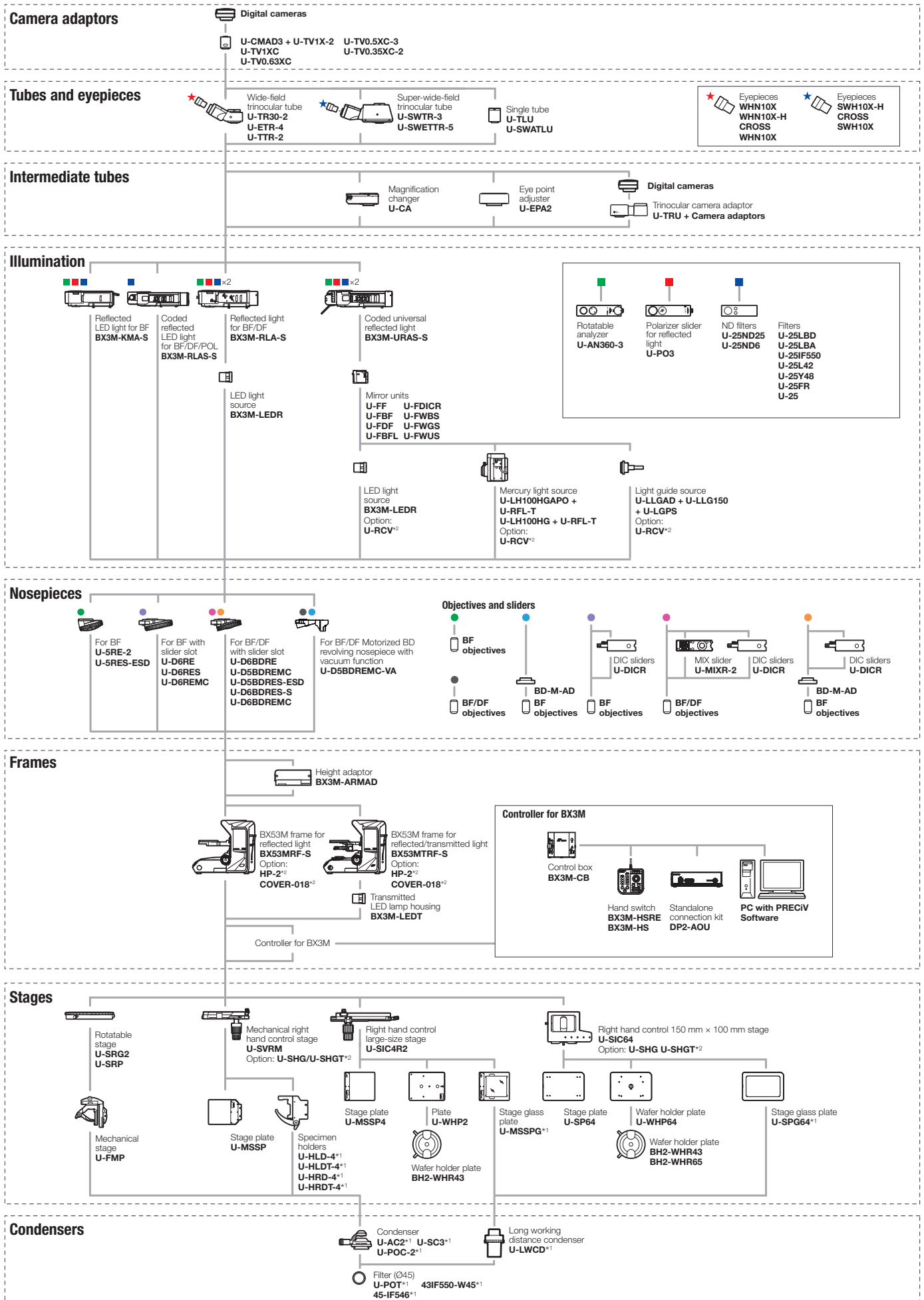

\*1 For transmitted light combination only  
\*2 Please select as necessary

## Control box and cable connection diagram

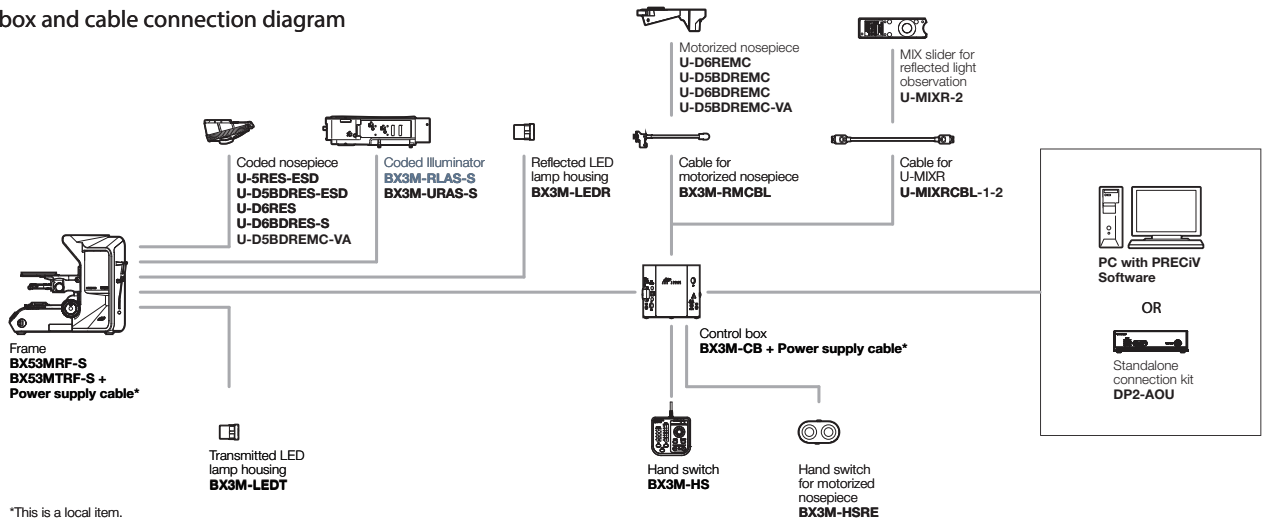

## Stand-alone light manager configuration

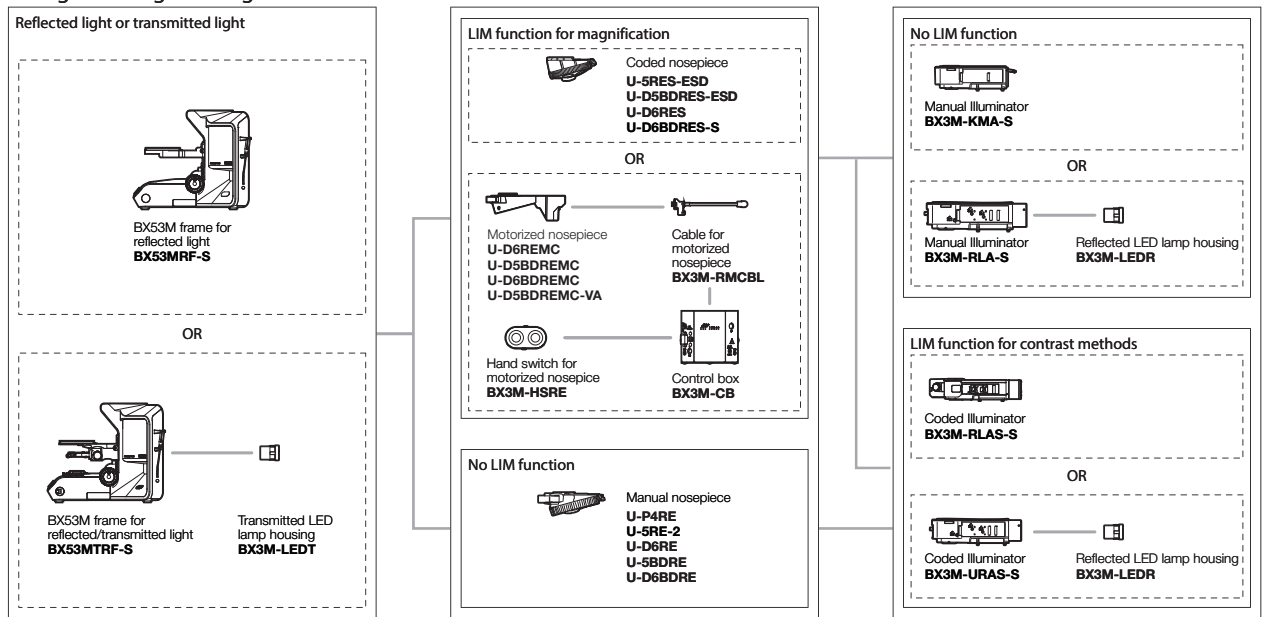

## MIX observation configuration

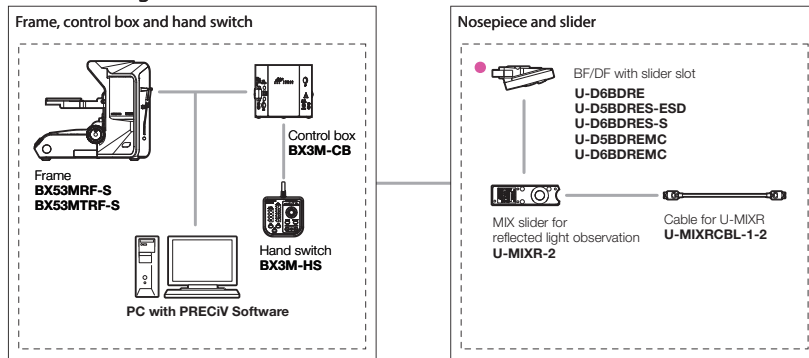

## Illumination and cable connection diagram

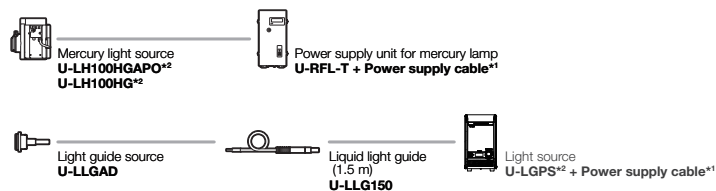

\*1 This is a local item.

\*2 Bulbs are required for these light sources.

# BXFM System Diagram

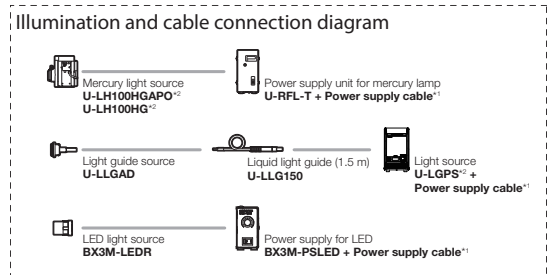
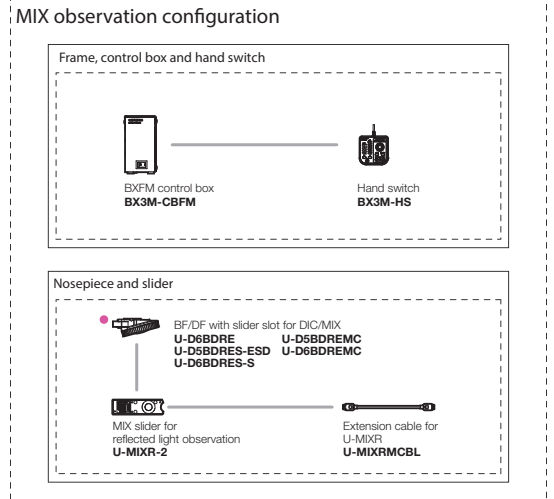
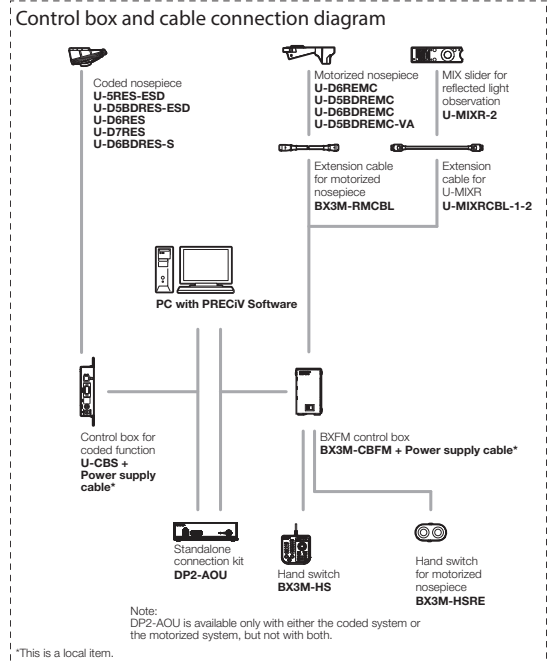
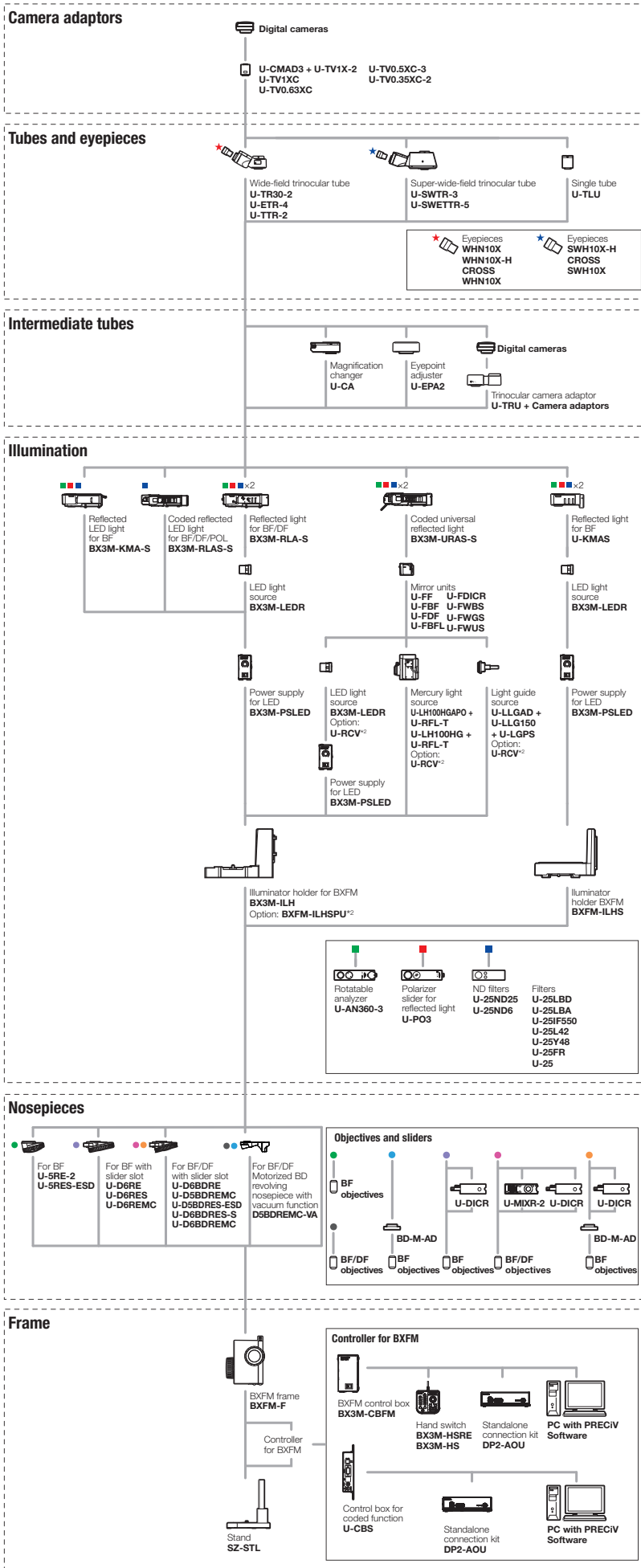

<sup>1</sup> This is a local item.  
<sup>2</sup> Bulbs are required for these light sources.

\*1 Please select as necessary



# BX53M System Diagram (for IR Observation)

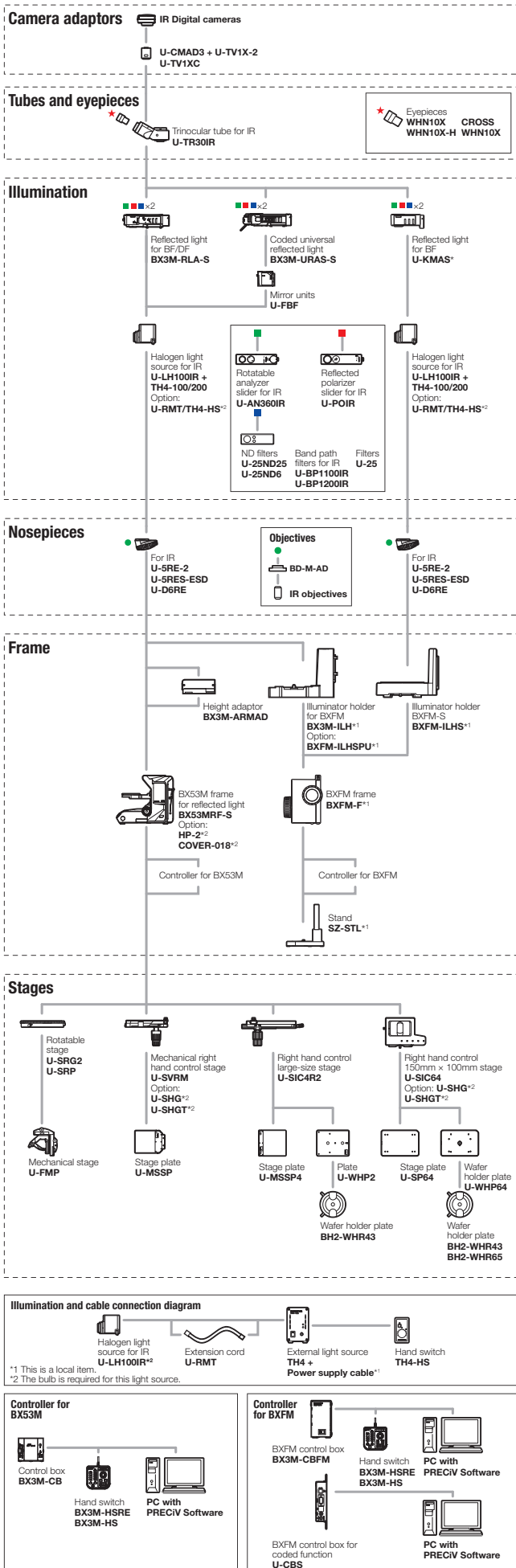

# BX53M System Diagram (for Polarized Observation)

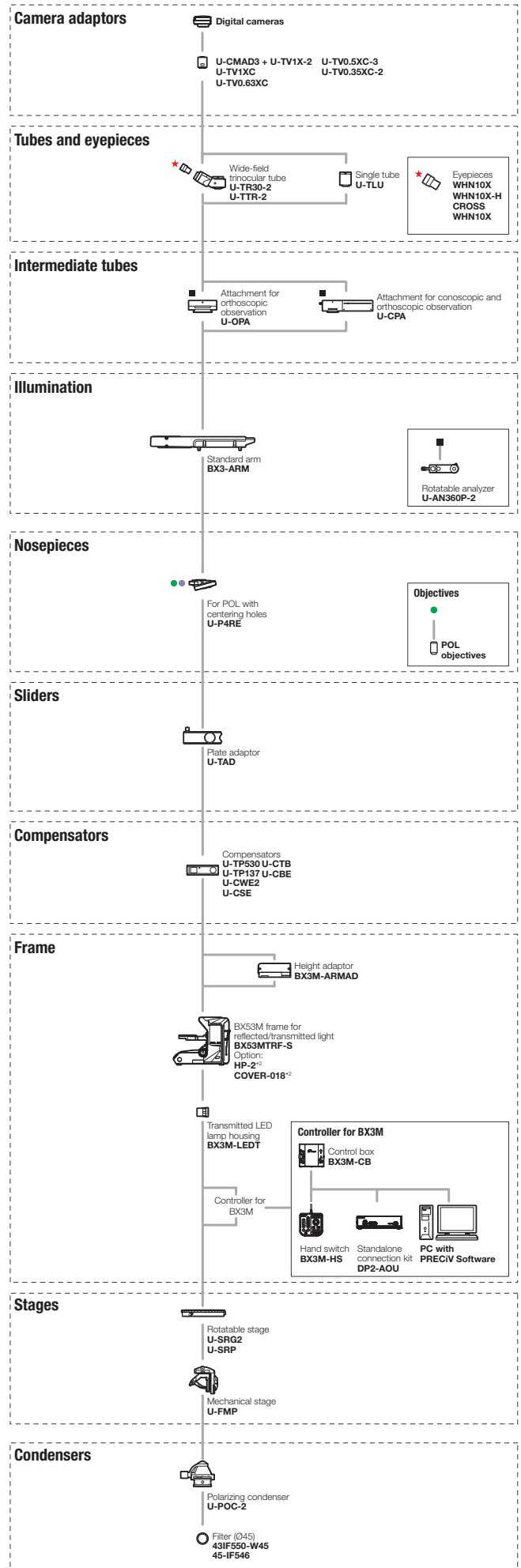

# Specifications

		Entry		Standard		Advanced		
Optical system		UIS2 optical system (infinity-corrected)						
Main-set	Microscope frame	<b>BX53MRF-S</b> (Reflected)	<b>BX53MTRF-S</b> (Reflected/transmitted)	<b>BX53MRF-S</b> (Reflected)	<b>BX53MTRF-S</b> (Reflected/transmitted)	<b>BX53MRF-S</b> (Reflected)	<b>BX53MTRF-S</b> (Reflected/transmitted)	
	Focus	Stroke: 25 mm						
		Fine stroke per rotation: 100 μm						
	Max. specimen height	Minimum graduation: 1 μm						
		With upper limit stopper, torque adjustment for coarse handle						
		Reflected 65 mm (w/o spacer) 105 mm (With BX3M-ARMAD) Reflected/transmitted 35 mm (w/o spacer) 75 mm (With BX3M-ARMAD)						
	Observation tube	Wide field (F.N.22) U-TR30-2 Inverted: trinocular						
	illumination	Reflected light	<b>BX3M-KMA-S</b> White LED, BF/DIC/POL/MIX FS, AS (with centering mechanism), BF/DF interlocking		<b>BX3M-RLAS-S</b> Coded, White LED, BF/DF/DIC/POL/MIX FS, AS (with centering mechanism), BF/DF interlocking			
		Transmitted light	—	<b>BX3M-LEDT</b> White LED Abbe/long working distance condensers	—	<b>BX3M-LEDT</b> White LED Abbe/long working distance condensers	—	<b>BX3M-LEDT</b> White LED Abbe/long working distance condensers
	Revolving nosepiece	<b>U-5RE-2</b> For BF: Quintuple			<b>U-D6BDRE</b> For BF/DF: Sextuple		<b>U-D6BDRES-S</b> For BF/DF: Sextuple, Coded	
	Eyepiece (F.N.22)	WHN10X WHN10X-H						
	MIX observation	—						<b>BX3M-CB</b> Control box <b>BX3M-HS</b> Hand switch <b>U-MIXR-2</b> MIX slider for reflected light observation <b>U-MIXRCBL-1-2</b> Cable for MIXR
	Condenser (Long working distance)	—	<b>U-LWCD</b>	—	<b>U-LWCD</b>	—	<b>U-LWCD</b>	<b>U-LWCD</b>
	Power cable	UYCP (x1)						<b>UYCP (x2)</b>
	Weight	Reflected: Approx. 15.8 kg (34.8 lb) (Microscope frame 7.4 kg) (16.3 lb) Reflected/transmitted: Approx. 18.3 kg (40.3 lb) (Microscope frame 7.6 kg) (16.8 lb)						
Objectives	MPLFLN set	<b>BF/POL/FL</b> observation <b>MPLFLN5X, 10X, 20X, 50X, 100X</b>		—				
	MPLFLN BD set	—		<b>BF/DF/DIC/POL/FL</b> observation <b>MPLFLN5XBD, 10XBD, 20XBD, 50XBD, 100XBD</b>				
	MPLFLN-BD, LMPLFLN-BD set	—		<b>BF/DF/DIC/POL/FL</b> observation <b>MPLFLN5XBD, 10XBD, LMPLFLN20XBD, 50XBD, 100XBD</b>				
	MPLFLN-BD, MXPLFLN-BD, LMPLFLN-BD	—		<b>BF/DF/DIC/POL/FL</b> observation <b>MPLFLN5XBD, 10XBD, MXPLFLN20XBD, 50XBD, LMPLFLN20XBD, 50XBD, 100XBD</b>				
Stage (X x Y)	76 mm x 52 mm set	Coaxial right handle stage/76 (X) x 52 (Y) mm, with torque adjustment <b>U-SVRM, U-MSSP</b>						
	100 mm x 100 mm set	Large-size coaxial right handle stage/100 (X) x 100 (Y) mm, with lock mechanism in Y axis <b>U-SIC4R2, U-MSSP4</b>						
	100 mm x 100 (G) mm set	Large-size coaxial right handle stage/100 (X) x 100 (Y) mm, with lock mechanism in Y axis (Glass plate) <b>U-SIC4R2, U-MSSPG</b>						
	150 mm x 100 mm set	Large-size coaxial right handle stage/150 (X) x 100 (Y) mm, with torque adjustment, with lock mechanism in Y axis <b>U-SIC64, U-SHG, U-SP64</b>						
	150 mm x 100 (G) mm set	Large-size coaxial right handle stage/150 (X) x 100 (Y) mm, with torque adjustment, with lock mechanism in Y axis (Glass plate) <b>U-SIC64, U-SHG, U-SPG64</b>						
Option	MIX observation set*	<b>BX3M-CB, BX3M-HS, U-MIXR-2, U-MIXRCBL-1-2</b>					—	
	DIC*	<b>U-DICR</b>						
	Intermediate Tubes	<b>U-CA, U-EPA2, U-TRU</b>						
	Filters	<b>U-25ND6, U-25ND25, U-25LBD, U-25LBA, U-25Y48, U-AN360-3, U-AN360P-2, U-PO3, U-25IF550, U-25L42, U-25, U-25FR</b>						
	Filter for condenser	<b>43IF550-W45, U-POT</b>						
	Stage plate	<b>U-WHP64, BH2-WHR43, BH2-WHR65, U-WHP2, BH2-WHR43</b>						
	Specimen holder	<b>U-HRD-4, U-HLD-4, U-HRDT-4, U-HLDT-4</b>						
	Handle rubber	<b>U-SHG, U-SHGT</b>						

\*Cannot be used with U-5RE-2.

## BX53M/BXFM ESD Units

Items	Microscope frame	<b>BX53MRF-S, BX53MTRF-S</b>
	Illuminator	<b>BX3M-KMA-S, BX3M-RLA-S, BX3M-URAS-S, BX3M-RLAS-S</b>
	Nosepiece	<b>U-D6BDREMC, U-D6BDRES-S, U-D5BDRES-ESD, U-5RES-ESD</b>
	Stage	<b>U-SIC4R2, U-MSSP4</b>

		Fluorescence	Infrared	Polarization
Optical system		UIS2 optical system (infinity-corrected)		
Microscope frame		<b>BX53MRF-S</b> (Reflected)	<b>BX53MTRF-S</b> (Reflected/transmitted)	<b>BX53MRF-S</b> (Reflected)
		Stroke: 25 mm		<b>BX53MTRF-S</b> (Reflected/transmitted)
Focus		Fine stroke per rotation: 100 µm		
		Minimum graduation: 1 µm		
Max. specimen height		With upper limit stopper, torque adjustment for coarse handle		
Wide field (F.N.22)		Reflected 65 mm (w/o spacer) 105 mm (With BX3M-ARMAD) Reflected/transmitted 35 mm (w/o spacer) 75 mm (With BX3M-ARMAD)		
Observation tube	Polarized Light Intermediate Attachment (U-CPA)	U-TR30-2 Inverted: trinocular		U-TR30-2 Inverted: trinocular for IR
		Bertrand Len		
		Bertrand Field Stop		
		Engage or disengage Bertrand lens changeover between orthoscopic and conoscopic observation	-	
Analyzer Slot				Rotatable Analyzer with Slot (U-AN360P-2)
Illumination	Reflected light	FL observation	BX3M-URAS-S Coded universal reflected light, 4 position mirror unit turret, (standard: U-FWUS, U-FWBS, U-FWGS, U-FBF etc) With FS, AS (with centering mechanism)	-
		IR observation	-	BX3M-RLA-S 100 W halogen lamp for IR, BF/IR, AS (with centering mechanism) U-LH100IR (Including 12V10W HAL-L) 100 W Halogen light source for IR TH4-100 100 W power supply TH4-HS Hand switch U-RMT Extension cord
	Transmitted light	POL observation	-	BX3M-LEDT White LED Abbe/long working distance condensers
Revolving nosepiece		U-D6BDRES-S For BF/DF: Sextuple, Coded	U-SRE-2 For BF: Quintuple	U-P4RE Quadruple, centerable attachable components 1/4 wavelength retardation plate (U-TAD), tint plate (U-TP530) and various compensators can be attached using plate adaptor (U-TAD).
Eyepiece (F.N.22)		WHN10X WHN10X-H		CROSS-WHN10X
Mirror units		U-FDF For DF U-FBFL For BF, built-in ND filter U-FBF For BF, detachable ND filter U-FWUS For Ultra Violet-FL U-FWBS For Blue-FL U-FWGS For Green-FL		-
Filter/Polarizer/Analyzer		U-25FR Frost filter	U-BP1100IR/U-BP1200IR Band path filters for IR	43IF550-W45 Green filter
		U-POIR Reflected polarizer slider for IR	U-AN360IR Rotatable analyzer slider for IR	U-AN360P-2 360° Dial-rotatable Rotatable minimum angle 0.1°
Condenser		U-LWCD Long working distance		U-POC-2 Achromat strain-free condenser 360°rotatable polarizer with swing-out achromatic top-lens. Click stop at position "0" is adjustable. NA 0.9 (top-lens in)/NA 0.18 (top-lens out) Aperture iris diaphragm: adjustable from 2 mm to 21 mm diameters.
Slider/Compensators				U-TAD Slider (Plate adaptor) U-TP530 Tint plate U-TP137 1/4 wavelength retardation plate
Power cable		UYCP (x1)		UYCP (x1)
Weight		Reflected: Approx. 15.8 kg (34.8 lb) (Microscope frame 7.4 kg (16.3 lb))	Reflected/transmitted: Approx. 18.3 kg (40.3 lb) (Microscope frame 7.6 kg (16.8 lb))	Approx. 18.9 kg (41.7 lb) (Microscope frame 7.4 kg (16.3 lb))
Reflected FL light source		U-LGPS, U-LLGAD, U-LLG150 Light guide set		
Mercury lamp		U-LH100HGAP01-7, USH-1030L (x2), U-RFL-T, U-RCV Mercurt lamp set		
MPLFLN set		BF/DIC/POL/FL observation MPLFLN5X, 10X, 20X, 50X, 100X		
MPLFLN BD set		BF/DF/DIC/POL/FL observation MPLFLN5XBD, 10XBD, 20XBD, 50XBD, 100XBD		
MPLFLN-BD, LMPLFLN-BD set		BF/DF/DIC/POL/FL observation MPLFLN5XBD, 10XBD, LMPLFLN20XBD, 50XBD, 100XBD		
MPLFLN-BD, MXPLFLN-BD, LMPLFLN-BD set		BF/DF/DIC/POL/FL observation, MPLFLN5XBD, 10XBD, MXPLFLN20XBD, 50XBD, LMPLFLN20XBD, 50XBD, 100XBD		
IR set		-		IR observation LMPLN5XIR, 10XIR, LCPLN20XIR, 50XIR, 100XIR
POL set				POL observation UPLFLN4XP, 10XP, 20XP, 40XP
76 mm x 52 mm set		Coaxial right handle stage/76 (X) x 52 (Y) mm, with torque adjustment U-SVRM, U-MSSP		
100 mm x 100 mm set		Large-size coaxial right handle stage/100 (X) x 100 (Y) mm, with lock mechanism in Y axis U-SIC4R2, U-MSSP4		
100 mm x 100 (G) mm set		Large-size coaxial right handle stage/100 (X) x 100 (Y) mm, with lock mechanism in Y axis (Glass plate) U-SIC4R2, U-MSSPG		
150 mm x 100 mm set		Large-size coaxial right handle stage/150 (X) x 100 (Y) mm, with torque adjustment, with lock mechanism in Y axis U-SIC64, U-SHG, U-SP64		
150 mm x 100 (G) mm set		Large-size coaxial right handle stage/150 (X) x 100 (Y) mm, with torque adjustment, with lock mechanism in Y axis (Glass plate) U-SIC64, U-SHG, U-SP64		
POL set				U-SRP+U-FMP Polarizing rotatable stage +Mechanical stage
MIX observation set*		BX3M-CB, BX3M-HS, U-MIXR-2, U-MIXRCBL-1-2		
DIC*		U-DICR		
Intermediate Tubes		U-CA, U-EPA2, U-TRU		
Filters		U-25ND6, U-25ND25, U-25LBD, U-25LBA, U-25Y48, U-AN360-3, U-AN360P-2, U-PO3, U-25IF550, U-25L42, U-25, U-25FR		
Filter for condenser		43IF550-W45, U-POT		
Stage plate		U-WHP64, BH2-WHR43, BH2-WHR65, U-WHP2, BH2-WHR43		
Specimen holder		U-HRD-4, U-HLD-4, U-HRDT-4, U-HLDT-4		
Handle rubber		U-SHG, U-SHGT		

\*Cannot be used with U-SRE-2.

# Dimensions

BX53M (for Reflected Combination)

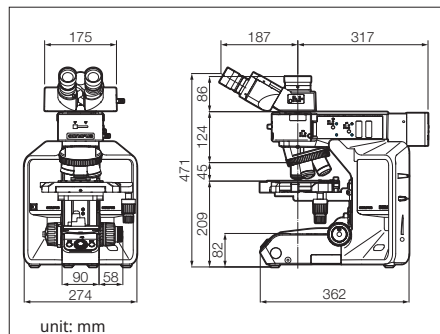

BX53M (for Reflected/Transmitted Light Combination)

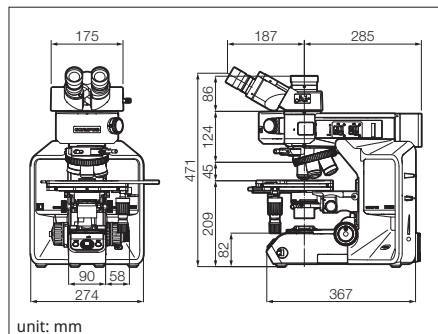

BXFM System

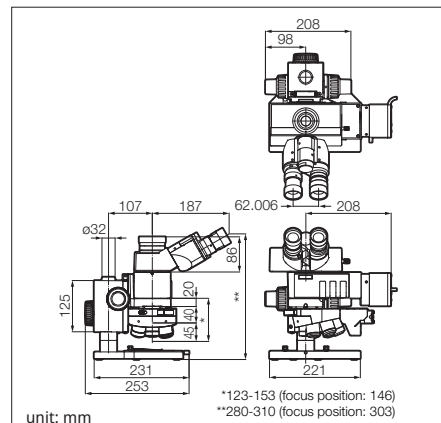

BX53M (for IR Observation)

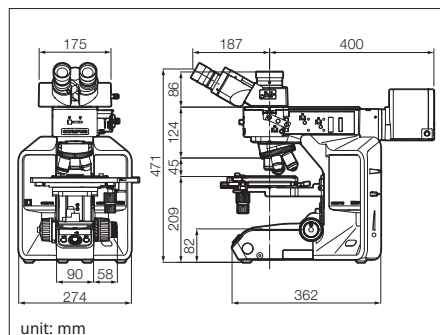

BX53M (for Polarized Observation)

