

**OLYMPUS**<sup>®</sup>

Your Vision, Our Future

Technical Cleanliness Inspection System

**CIX100**

OLYMPUS CIX series

# Turnkey Solution for Technical Cleanliness Inspection

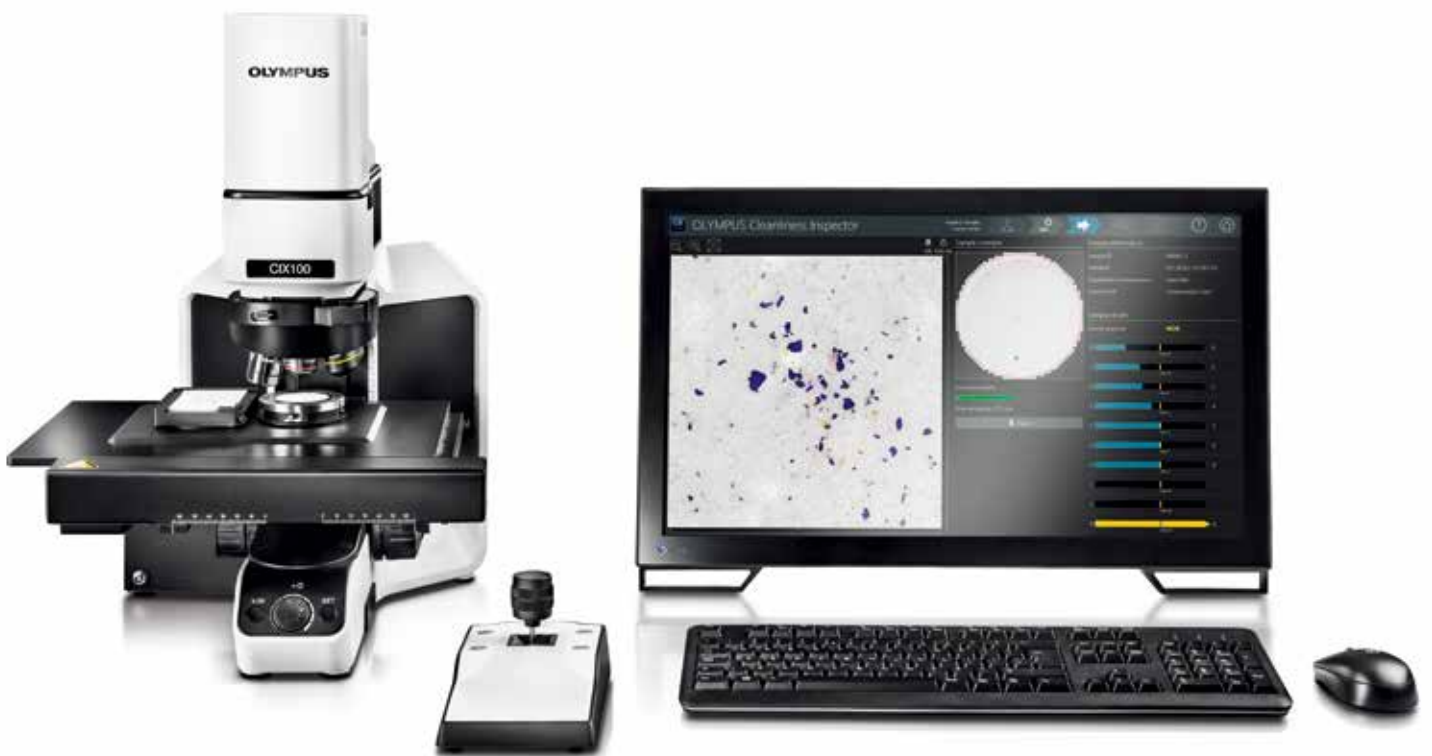

# Simplify Your Technical Cleanliness

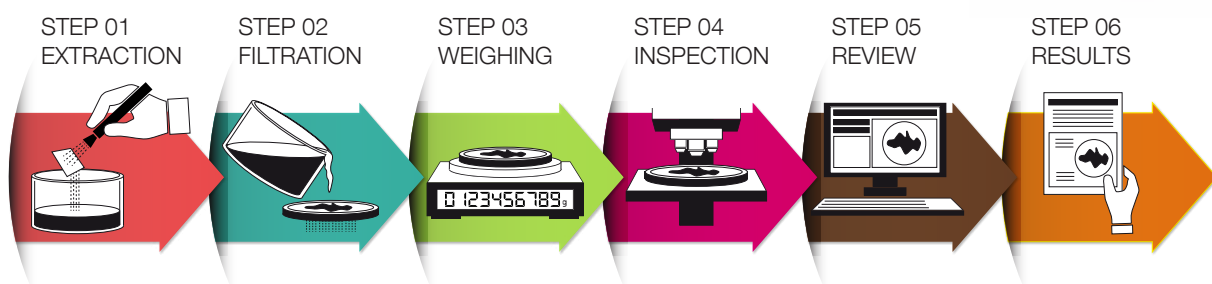

Standard process for cleanliness inspection: preparation (steps 1 – 3) and investigation (steps 4 – 6)

The cleanliness of components and parts is at the center of the manufacturing process. Meeting high standards for counting, analyzing, and classifying the often micron-sized contaminant and foreign particles is important for all processes: development, manufacturing, production, and quality control of the final product. International and national directives describe the methods and documentation requirements for determining particle contamination on essential machined parts since these particles directly impact the lifespan of parts and components. Previously, the mass of residue particles was used to characterize the residue. The standards in use today demand more detailed information about the nature of the contamination such as the number of particles, particle size distribution, and particle characteristic.

The OLYMPUS CIX100 Cleanliness Inspection System is designed to meet the cleanliness requirements of modern industry and national and international directives.

## A Complete Solution to Cleanliness Process Control

### Reliable

---

Seamlessly integrated hardware and software result in a durable, high-throughput system that delivers reliable and accurate data.

### Intuitive

---

Dedicated, easy-to-use workflows minimize user action and guarantee reliable data — independent of the operator and experience level.

### Fast

---

The innovative all-in-one-scan solution enables scans to be completed twice as fast as other inspection systems. Counted and sorted particles are displayed live while powerful, easy-to-use tools make it easy to revise inspection data.

### Compliant

---

One-click reporting meets the requirements and methodologies set forth in international standards.

# Reliable Turnkey System Solution: Automated and Accurate For High Reproducibility.

The OLYMPUS CIX100 system is a turnkey solution designed to meet the needs of automated cleanliness inspection. Each component is optimized for accuracy, reproducibility, repeatability, and seamless integration for reliable data in a high-throughput system. The system is designed for excellent optical performance, reproducible observation conditions, and repeatability. At the same time, this cleanliness inspection system helps minimize human error by automating critical tasks.

## Reproducible Imaging Conditions

Highest reproducibility by protected camera alignment to prevent unwanted misalignments.

## Excellent Optical Quality

Perfect image quality for analysis by excellent optical components, like Olympus UIS2 objectives and high resolution camera.

## Proven Durability

Accurate and reproducible positioning and an improved focus drive guarantee reproducible positioning. The stage insert maintains a secured membrane position and features an additional insert for the integrated calibration tool.

## Reproducibility and Repeatability

The OLYMPUS CIX100 system is easy to use, so even inexperienced inspectors can acquire accurate and reliable data. Preconfigured hardware and dedicated system solutions help ensure that your settings are correct for accurate and repeatable inspection results.

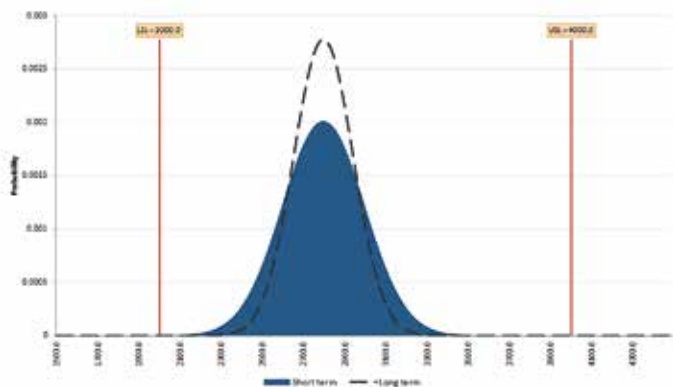

The diagram illustrates the OLYMPUS CIX100 precision by verify the measurement stability and repeatability using the Process Performance Index ( $P_{pk}$ ). The same sample at 5x and 10x magnification was measured several times (10 times) and the particle count from typical size classes was extracted. The diagram shows the evaluation of  $C_{pk}$  and  $P_{pk}$  on class E (50-100  $\mu\text{m}$ ).

## Excellent Optical Quality



Olympus' high-quality UIS2 objectives help ensure the best optical performance for excellent measurement and analysis accuracy. A dedicated light source maintains a consistent color temperature optimized for cleanliness inspection.

### Innovative Polarization Method

Detects both reflective (metallic) and non-reflective particles in a single scan.

### Easy to Use

Simple and easy-to-use software with intuitive step-by-step workflows leads users through the complete inspection process and helps minimize operator error.



### High Performance

The powerful workstation is equipped with a touch-screen monitor for efficient operation.

## Optimized Reproducibility

Reproducibility has been optimized by eliminating moving parts from the illumination light path, maximizing automatic functionality, and creating intuitive workflows that limit potential operator errors. The integrated calibration slide helps maintain regular system verification.



## Secure Setup

The optical path alignment, motorized nosepiece, and the camera are protected by a cover to prevent any accidental modifications.





# Intuitive Guidance for Maximum Productivity

The OLYMPUS CIX100 system delivers enhanced performance and productivity through the entire inspection process and is designed to make cleanliness inspection easy for inspectors of every experience level. The software provides step-by-step guidance through the complete cleanliness inspection. Intuitive workflows improve productivity and confidence in results while reducing cycle time, cost-per-test, and handling errors. The result is a system optimized to maintain high quality standards.

## Management Tools

The OLYMPUS CIX100 system enables administrators to control which users have access to different parts of the system. Depending on an operator's level of experience, the system administrator can define variable roles and choose which functionality to assign to operators. Power users may have access to the complete system setup, while inexperienced users can be limited to basic workflows. This functionality helps ensure that inexperienced users generate reliable results.

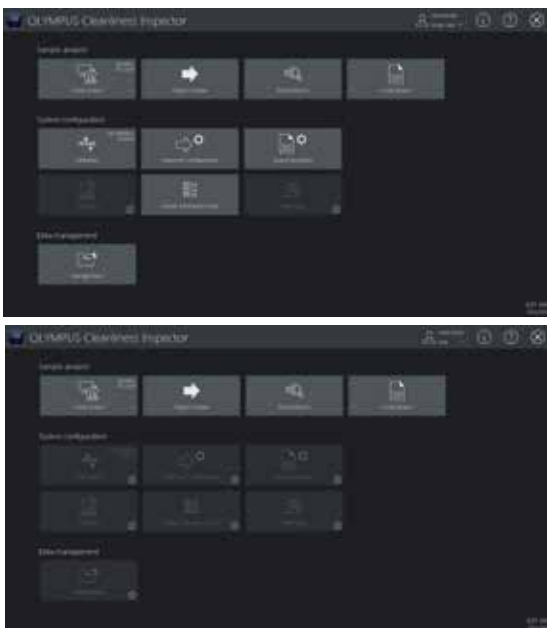

User rights allows the administrator to define roles for operators with marked-off functionality

## Use the Entire Screen

The full-screen application enables the operator to view the sample using maximum screen space without disturbing the computer's task bar.

## Reliable Data

The system regularly reminds to perform automatic system checks for accurate results.

## Easy for Every Experience Level

The combination of a pre-configured, pre-calibrated system and intuitive user interface helps make cleanliness inspection easy for inspectors of every experience level.

## Storage and Sharing

All data is saved automatically. Quick access all of the archived samples and their associated data and reports for revision or information distribution.

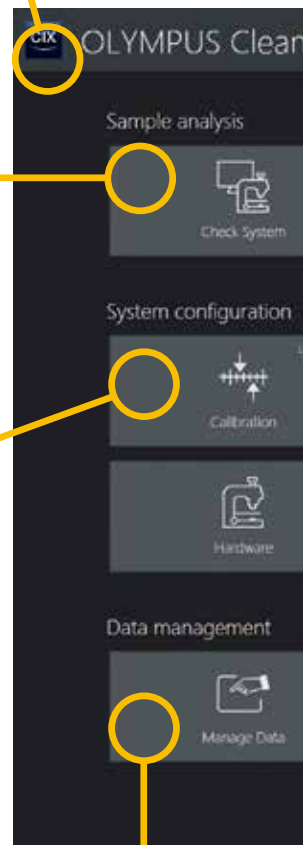

## Inspect a Sample

Step-by-step the intuitive interface guides operators of any experience level through the complete investigation process and minimizes inspection and process time for daily use.



### Straight to Inspection

Start scanning the membrane using the selected inspection configuration.

### Straight to Revision

Review scanned or stored results, including validation.

### Straight to Report

Create or print reports that comply with industry standards based on the inspection results.

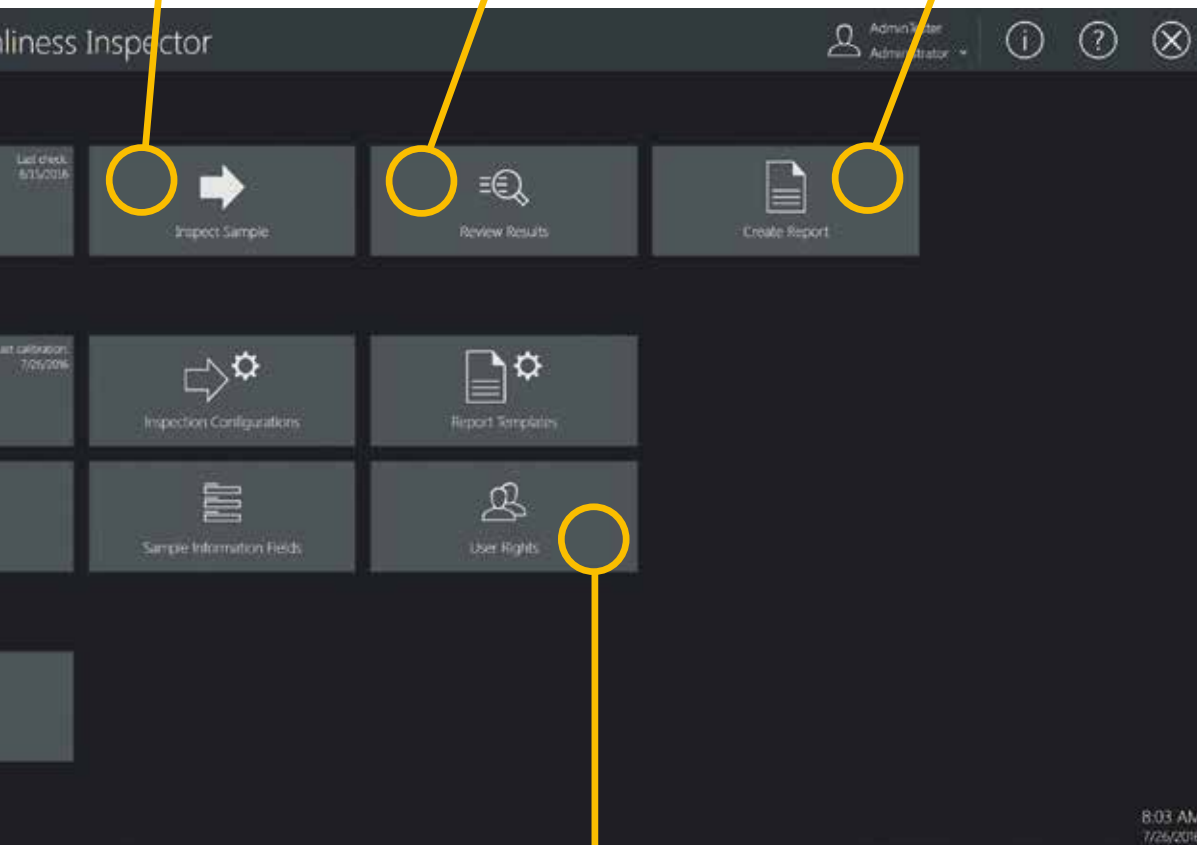

### Administrative Support

The administrator is able to control the operating rights of individual users.

## Touch Screen Support

The OLYMPUS CIX100 software's large buttons are perfect for working with the system's modern and efficient touch-screen technology.

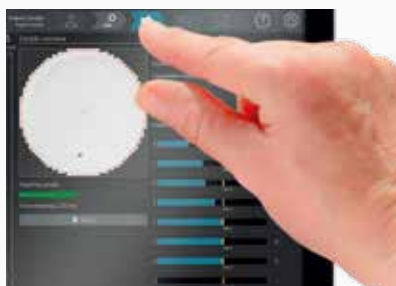

## Inspection Configurations

Inspection configurations are used to specify all of the parameters for sample inspection, including rules for the characterization of particles, setting particle families, and types.

Access to the inspection configurations		ISO 11218:1991
		ISO 12345:2013
		ISO 14952:2003
Specification of settings for the standard		ISO 16232-10:2007 (A)
		ISO 16232-10:2007 (B)
Specification of settings for the particle family		ISO 16232-10:2007 (C)
		ISO 4406:1999
		ISO 4407:1991
Specification of settings for the particle types		NAS 1638 - 1964
		NF E 48-65:1986



# Fast Live Analytics and Review. Full Confidence in Results.

## All Relevant Data Displayed in One Place

The OLYMPUS CIX100 system offers high-performance image acquisition and accurate live analytics of both reflective and non-reflective particles ranging from 2.5  $\mu\text{m}$  up to 42 mm in a single scan thanks to an innovative polarization method. This all-in-one-scan solution enables scans to be completed twice as fast as other inspection systems. Counted and sorted particles are displayed live and sorted into size classes, supporting direct decision making for reprocessing and helping ensure a fast reaction time in case of a failed test.

## Fast: Capture Data in a Single Scan

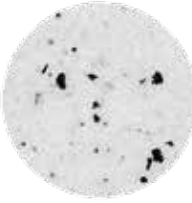
An innovative polarization method based on wavelength separation and color detection detects both reflective (metallic) and non-reflective particles in a single scan. Integrated into the microscope frame, this high-throughput design enables scans to be completed twice as fast as other inspection systems and eliminates operator interaction with system components, such as the polarizer, which can negatively impact the system settings, leading to potentially incorrect results. This all-in-one-scan technique increases the number of inspected particles, reducing the cost per test and shortening the reaction time in case of a failed test.

'Classical' method		'New' method
Non-reflecting	Reflecting	Combined
		

### Short Reaction Time

All relevant data are displayed live on a single screen during the inspection, enabling the operator to stop or interrupt the inspection if a test fails.

### High Throughput

The innovative all-in-one-scan technology detects both reflective and non-reflective objects in one scan.

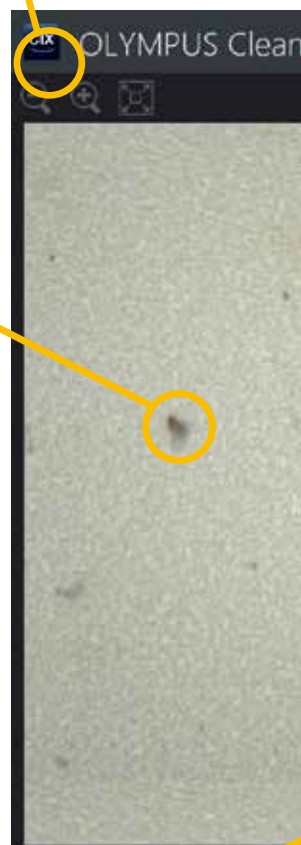

### Detect Small and Large Particles

Live processing and classification of both small and large particles according to international standards (2.5  $\mu\text{m}$  up to 42 mm).

## Intelligent Handling of Large Particles

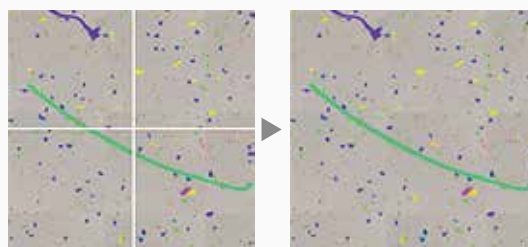

The OLYMPUS CIX100 system offers live processing of contaminant particles ranging from 2.5  $\mu\text{m}$  up to 42 mm and automatically reconstructs images of large particles.



### Direct Identification

The overview image assists with evaluating filter coverage, particle clustering, or worst particles, so users can react quickly before the final inspection starts

### Sample Information Overview

Inspection configurations are used to specify all parameters for sample inspection.

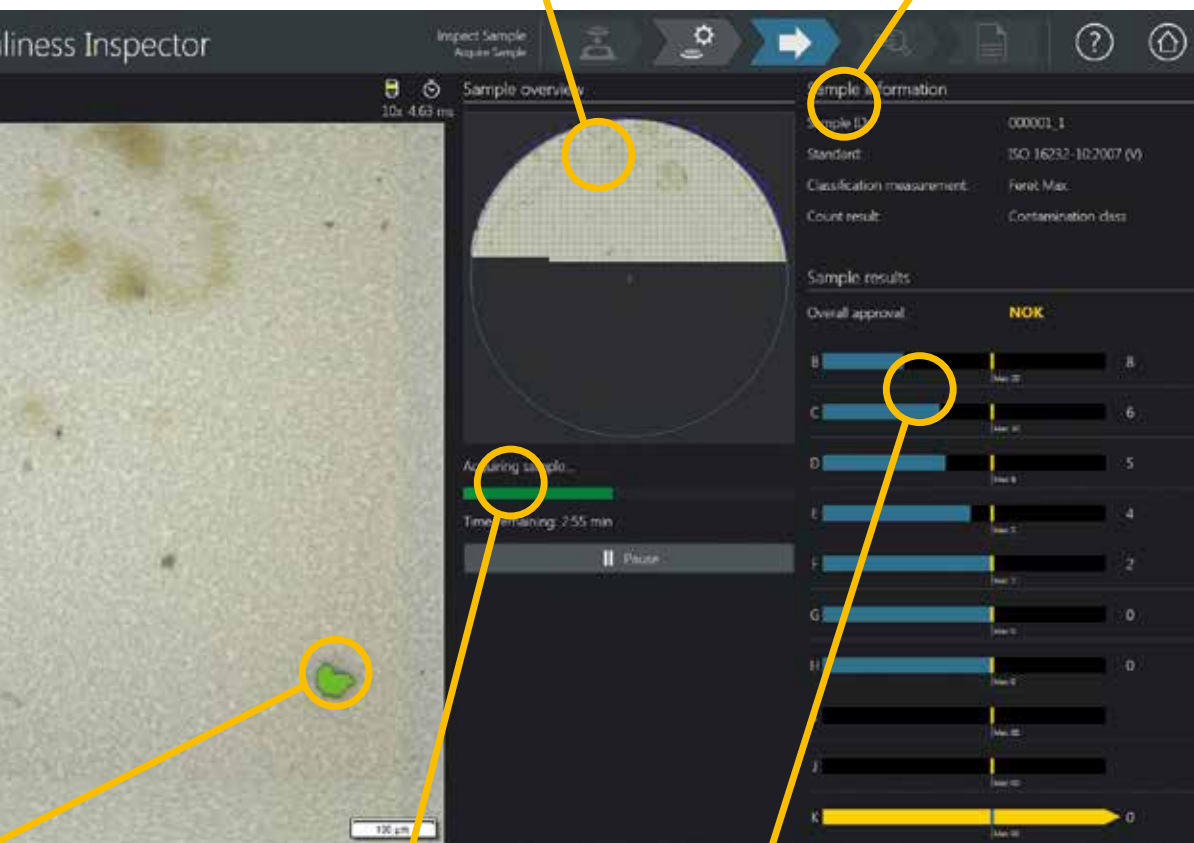

### Time Information

Clearly view the time remaining for sample acquisition.

### Live Analytics

Contaminants are automatically analyzed and sorted into size class bins defined by the selected standard.

## Overview Image

The sample overview image is created at the beginning of the sample inspection and displays the entire filter at low magnification. The overview image helps to identify filter coverage or particle clusters before the sample inspection starts.

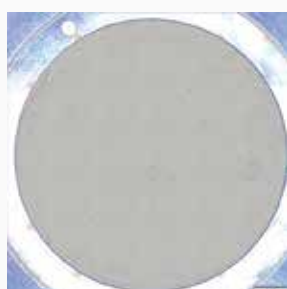

## Direct Result Feedback

Predefined acceptable particle counts per size classes are displayed and the sample can be validated (OK) or rejected (NOK) even before the complete membrane is acquired.



## Flexible for Evaluation and Revision

The OLYMPUS CIX100 system includes powerful and easy-to-use tools to revise inspection data with a fast guided particle review. The one-click reclassification function provides users flexibility and supports international standards. Thumbnail images of every contaminant detected by the system are linked together with dimensional measurements, making it easy to review the data. Retrieving a particular contaminant's information is simple. Through the review process, all results are updated and displayed automatically in all views and size classification bins. This leads to maximum time savings with clear representations of all relevant inspection results.

## Quick and Easy: Review, Revise, and Recalculate

Operators can easily revise their inspection data. Powerful software tools including delete, split, and merge make revising the data simple.

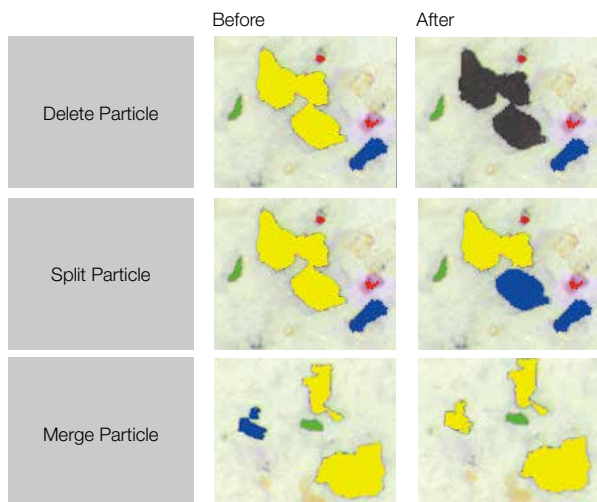

The OLYMPUS CIX100 system has tools that make it easy to revise inspection data during the review step.

## Complete Dataset

All particles and classification tables, overall cleanliness code, particle location, and the standard used appear in one view.

## Deep Data Insights

At-a-glance display of complete inspection data in various selectable views.

## Direct Identification

View images of particles organized from largest to smallest for all kind of particles (reflective or non-reflective).



## Data Visualization



Thumbnail images are linked with their data, making revision convenient.

### Revise Inspection data

The software contains powerful tools to revise the inspection data or perform height measurement.

### Proven Guarantee

Reproducibility and repeatability since particle location, thumbnails, and data are linked together.

### Fully Compliant

Results can be recalculated to all standards with a click of a mouse.

### Direct Feedback

Calculate and display the overall contamination class code (CCC) according to the selected standard.

### Trusted Results

Classification and particle tables show the results according to the selected standard and particle data respectively.

### Advanced Particle Information

As an optional feature, results of height measurements for selected particle are automatically added to the result sheet for further investigation.

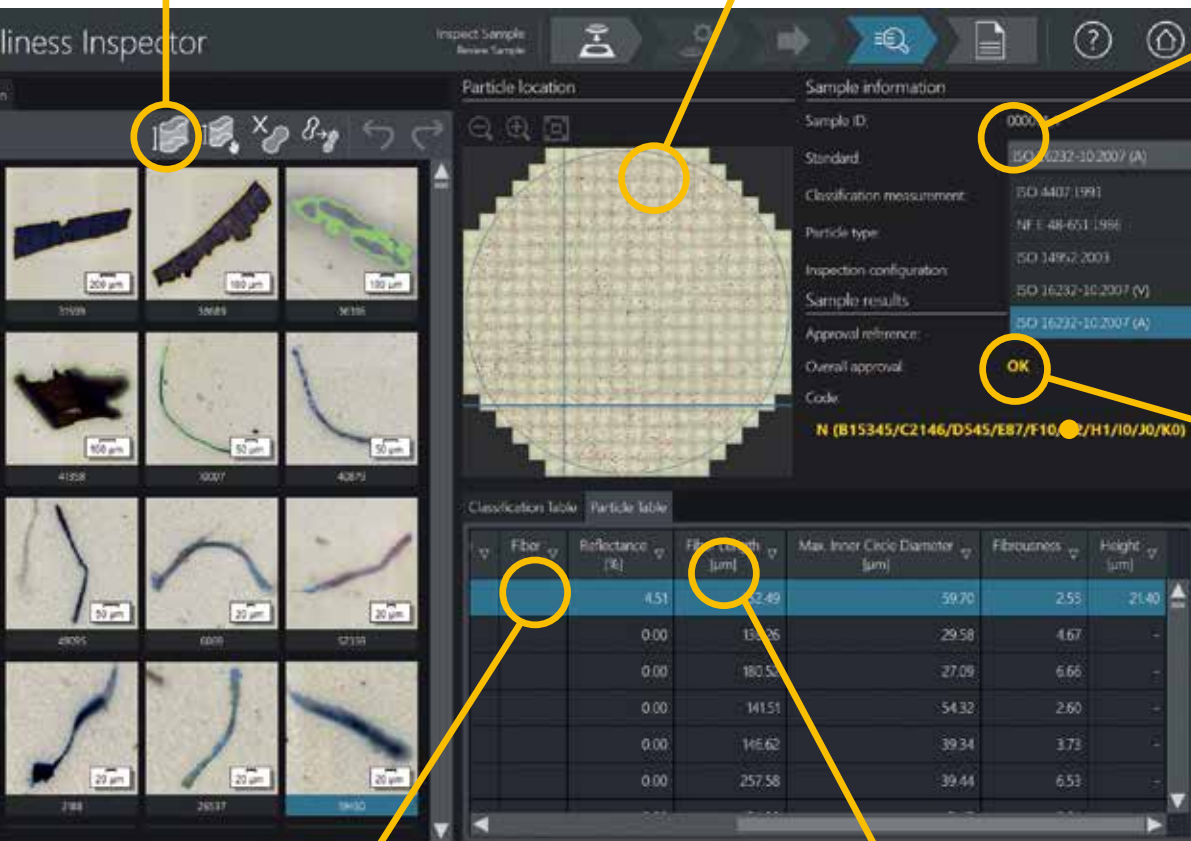

## Confidence in Your Data

Class	Range	Absolute Count	Normalized Count [1/1000 cm <sup>2</sup> ]	Confirms Class
B	(5.00 - 15.00]	27760	80463.77	17
C	(15.00 - 25.00]	5016	14339.13	14
D	(25.00 - 50.00]	2218	6428.99	13
E	(50.00 - 100.00]	841	2437.68	12

Classification and particle tables list the results according to the selected standard.

## Define Company Standards

Evaluation is performed according to all major international standards used in the automotive and aerospace industries. Companies also have the flexibility to set up their own evaluation standards.



# Efficient Report Creation

The smart and sophisticated reporting tools based on predefined templates that comply with industry standards enable easy one-click digital documentation of the inspection results. The results are created in Microsoft Word 2016 and can also be directly exported as PDF so that data can easily be sent via email. Report templates help inexperienced operators avoid mistakes, but can be easily modified to meet the needs of your company. Tools for data sharing and reporting save time and increase reaction time and productivity. The OLYMPUS CIX100 system can also archive reports and data for record keeping.

## Professional Appearance by Everyone

Every operator is able to generate high-quality reports via the predefined templates .

## Intuitive

Analytical reports that comply with the standard used during analysis and customizable templates with a single mouse click.

## Flexibility

Supports different output formats including MS Word and PDF.

## Complete Adaptable

Templates and reports can be easily adapted to meet company regulations

## Height Measurement Solution

The OLYMPUS CIX100 system's functionality can be enhanced with a height measurement solution consisting of a 20X objective and special software to fulfill the VDA 19 requirements for height measurements. For selected particles, the height measurement is performed either automatically or manually. The calculated height value is listed as an additional data field in the results sheet.

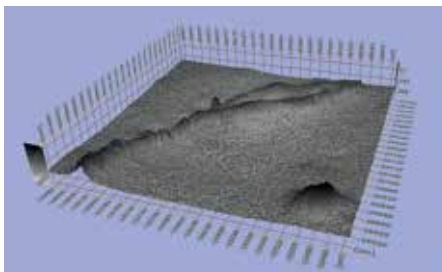

## Predefined Templates

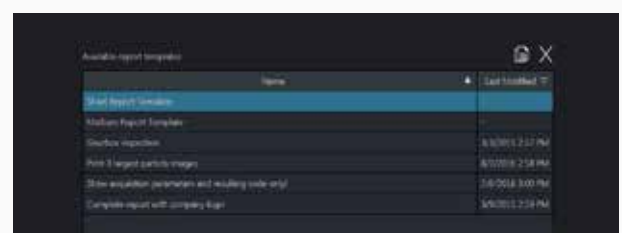

The smart and sophisticated reporting tools of the OLYMPUS CIX100 system are based on predefined, professional-looking templates. All available templates are clearly listed.



### Smart Variability

Reports are performed according to the methodologies set forth in international standards.

### Straight to Report

Create or print compliant reports based on further inspections.

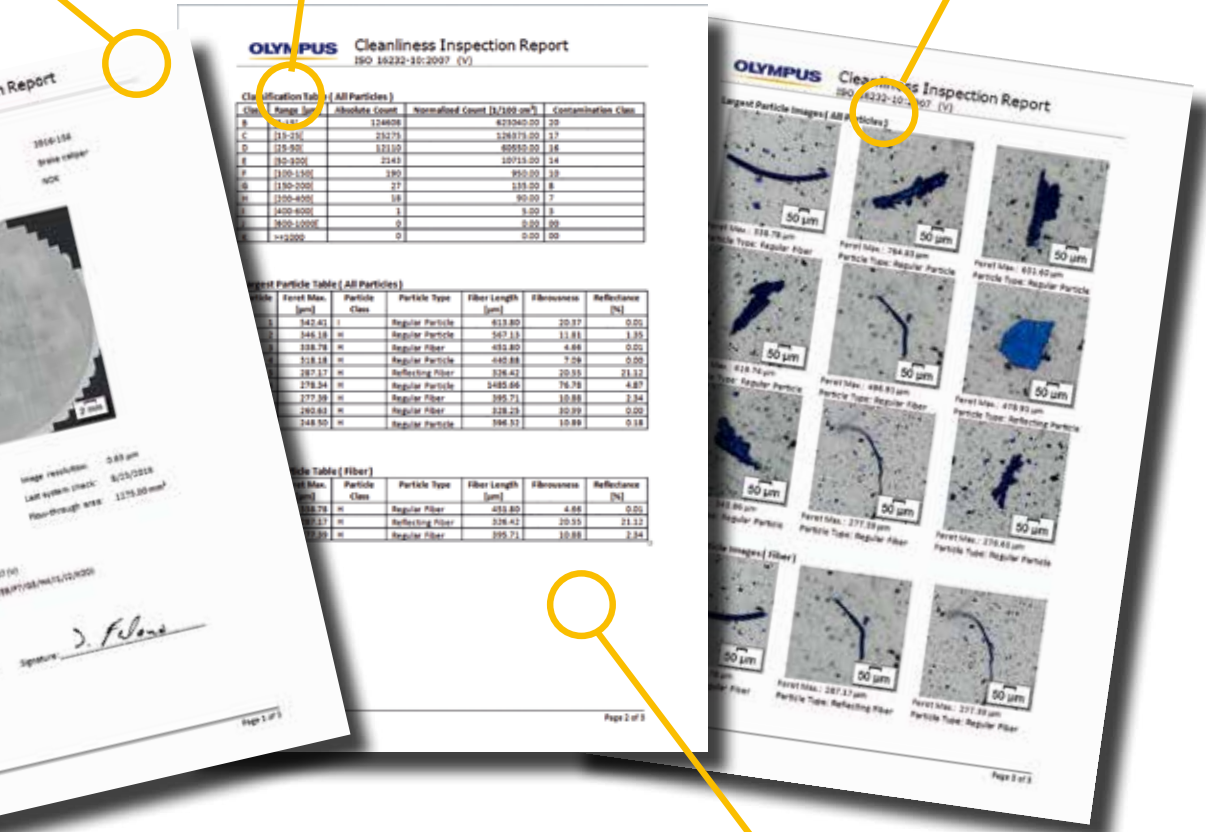

### Easy Result Sharing

Report file sizes are optimized for efficient exchange

### Long-term Data Storage

Capability to justify decision after years.

## Easy Data Export

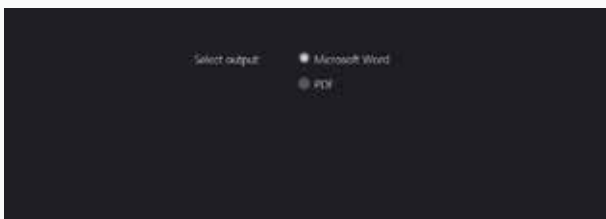

Exporting a report is as easy as clicking your mouse. The operator can choose to export the reports into MS Word or PDF, depending on their requirements and needs.

## Long-Term Data Safety

Inspection data and reports need to be achieved for a certain period of time.





## Hardware

Microscope	OLYMPUS CIX100	Motorized focus	<ul style="list-style-type: none"> <li>Coaxial motorized fine focus with 3 axis joystick</li> <li>Focus stroke 25mm</li> <li>Fine stroke 100 <math>\mu\text{m}</math> / rotation</li> <li>Maximum height of stage holder mounting : 40 mm</li> <li>Focus speed 200 <math>\mu\text{m}/\text{sec}</math></li> <li>Software autofocus enabled</li> <li>Customizable multi-point focus map</li> </ul>
		Illumination	<ul style="list-style-type: none"> <li>Built-in LED illumination</li> <li>Illumination mechanism with simultaneous detection of reflecting and non-reflecting particles</li> <li>Light intensity pre-set at factory</li> </ul>
		Imaging device	<ul style="list-style-type: none"> <li>Color CMOS USB 3.0 camera</li> <li>On chip pixel size 2.2 x 2.2 <math>\mu\text{m}</math></li> </ul>
		Sample height	<ul style="list-style-type: none"> <li>Sample is limited to filter membrane (diameter 42 mm) mounted into the provided filter holder.</li> </ul>
Noise piece	Motorized type	Motorized Nosepiece	<ul style="list-style-type: none"> <li>6 positions motorized nosepiece with 3 UIS2 objectives already installed</li> <li>PLAPON 1.25X used for preview</li> <li>MPLFLN 5X used for detecting particles bigger than 10 <math>\mu\text{m}</math></li> <li>MPLFLN 10X used for detecting particles bigger than 2.5 <math>\mu\text{m}</math></li> </ul>
		Software controlled	<ul style="list-style-type: none"> <li>The image magnification and relation between pixel and size is known at every moment.</li> <li>Selected objectives are used at selected steps into the measurement process, objectives are automatically positioned</li> </ul>
Stage	Motorized stage X,Y	Motorized stage X,Y	<ul style="list-style-type: none"> <li>Stepper motors controlled movement</li> <li>Maximum range : 130 x 79 mm</li> <li>Max speed 240 mm/s (4 mm ball screw pitch)</li> <li>Repeatability &lt; 1 <math>\mu\text{m}</math></li> <li>Resolution 0.01 <math>\mu\text{m}</math></li> <li>Controllable with 3 axis joystick</li> </ul>
		Software controlled	<ul style="list-style-type: none"> <li>Scanning speed is depending on the used magnification, at 10x the guaranteed scanning speed is less than 10 minutes</li> <li>Stage alignment is performed at factory assembly</li> </ul>
	Specimen holder	Sample holder	<ul style="list-style-type: none"> <li>Membrane holder is specially designed to avoid an unwanted rotation of the membrane during the mounting</li> <li>The membrane is mechanically flattened by the membrane holder</li> <li>No tool is needed to fix the cover</li> <li>The sample holder is always assigned the slot 1 on the stage</li> </ul>
		Particle Standard Device (PSD)	<ul style="list-style-type: none"> <li>Reference sample used to validate the system measurement</li> <li>Sample used in the check system built-in function for controlling the proper function of the CIX</li> <li>The PSD is always assigned slot 2 on the stage</li> </ul>
	Stage insert	2-Position stage insert	<ul style="list-style-type: none"> <li>Stage insert dedicated to the right positioning of the sample holder and the PSD</li> </ul>
Controller	Workstation	High-Performance pre-installed workstation	<ul style="list-style-type: none"> <li>HP Z440, Windows 10-64 bit Professional (English)</li> <li>16 GB RAM, 256 GB SSD and 4 TB data storage</li> <li>2GB video adapter</li> <li>Microsoft Office 2016 (English) installed</li> <li>Networking capabilities, English qwerty keyboard, optical mouse 1000 dpi</li> </ul>
		Add-in boards	<ul style="list-style-type: none"> <li>Motorized controller, RS232 serial and USB 3.0</li> </ul>
		Language selection	<ul style="list-style-type: none"> <li>Operating system and Microsoft Office default language can be changed by the user</li> </ul>
	Touch panel display	23 inch slim screen	<ul style="list-style-type: none"> <li>Resolution 1920x1080 optimized for use with the CIX software</li> </ul>
Power	Rating	<ul style="list-style-type: none"> <li>AC adapter (2), Controller and Microscope frame (4 plugs necessary)</li> <li>Input: 100-240V AC 50/60Hz, 10 A</li> </ul>	
	Power consumption	<ul style="list-style-type: none"> <li>Controller: 700W; Monitor: 56 W; Microscope: 5.8 W; Control Box 7.4 W</li> <li>Total: 769.2 W</li> </ul>	
Drawing	Dimensions (W x D x H)	Approx. 1300 mm x 800 mm x 510 mm	
	Weight	44 kg	

## System environment limitations

Normal use	Temperature	10 – 35° C
	Humidity	30 – 80 %
For safety regulations	Environment	Indoor use
	Temperature	5 – 35 °C
	Humidity	<ul style="list-style-type: none"> <li>Maximum 80% (up to 31 °C) (no condensation)</li> <li>Usable humidity declines linearly as temperature rises above 31°C</li> <li>34°C (70%) to 37°C (60%) to 40°C (50%)</li> </ul>
	Altitude	Up to 2000 m
	Level of horizon	Up to $\pm 2^\circ$
	Power supply and voltage stability	$\pm 10\%$
	Pollution level (IEC60664)	2
	Overall voltage category (IEC60664)	II

## Software

Software	CIX-ASW-V1.1 Dedicated workflow software for Technical Cleanliness Inspection
Languages	GUI : English, French, German, Spanish, Japanese, Simplified Chinese and Korean Online help: English, French, German, Spanish, Japanese, Simplified Chinese and Korean
License management	Software license activated by license card (already activated at installation)
User management	System can be connected to a network for domain administration Software uses Windows user rights to identify who is using the system
Live image	Display in color mode Window fit method Live detection - Particles are detected as soon as they are captured for improved speed - User can stop the process if the measurement results are not good
Hardware control	XY motorized stage - Joystick operation and control by software - Automatic or manual repositioning on selected particles Motorized nosepiece: Selection by software only Motorized focusing - Control by joystick - Software autofocus available - Predictive autofocus using multipoint focus map Light control: Light intensity is automatically controlled by software
Check system	System verification - System is verified by measuring the PSD parameters - OK or NOK quality value is produced
Technical cleanliness standards	Supported standards: ISO 11218:1993; ISO 14952; ISO 16232-10; ISO 21018; ISO4406:1999; ISO4407:1991; ISO12345:2013; NAS 1638-01; NF E48-651:1986; NF E48-655:1989; SAE AS4059E Fully compliant to VDA19:2016 recommendations Identification of particle family: particles can be classified by particle families (fibers, reflecting, reflecting fibers, or others) Customized standards: User defined standards can be defined easily Inspection configuration: The system allows to load, define, copy, rename, delete and save an inspection configuration
Particle tile view	Displays the detected particles in tile view for improved navigation
Store the full membrane	The complete filter is stored and can be reprocessed using different conditions
Particle Edition	Particles can be edited during the revision process. It is possible to: - Delete, Merge, Add Particle - Change the particle type
Dynamic reports	Professional analytical reports can be produced by using Microsoft Word 2016 Templates are fully customizable

## Optional Solution CIX-S-HM

Height Measurements	Automatic or manual height measurement of selected particles	- Optional software solution which drives the motorized focus drive from top to bottom of selected particles. The particle height is then processed from the difference between the top and the bottom Z coordinate. - Includes an additional objective lens (20x MPLFLN) and a license card that needs to be activated at installation.
---------------------	--	--

## Environment law and regulations

Europe	Low Voltage Directive 2014/35/EU
	EMC Directive 2014/30/EU
	RoHS Directive 2011/65/EU
	REACH Regulation No. 1907/2006
	Packaging and Packaging Waste Directive 94/62/EC
	WEEE Directive 2012/19/EU
USA	Machinery Directive 2006/42/EC
	UL 61010-1:2010 Edition 3 FCC 47 CFR Part15 SubPartB
Canada	CAN/CSA-C22.2 (No. 61010-1-12)
Australia	Radio communications Act 1992, Telecommunications Act 1997
	Regulation on Energy conservation AS/NZS 4665-2005
Japan	Electrical Appliances and Material Safety Act (PSE)
Korea	Electrical Appliances Safety Control Act
	Regulation on Energy Efficiency Labeling and Standards
	Regulations for EMC and Wireless Telecommunication (Notice 2913-5)
China	China RoHS
	China PL Law
	Regulation for Manuals

# Dimensions

CIX100

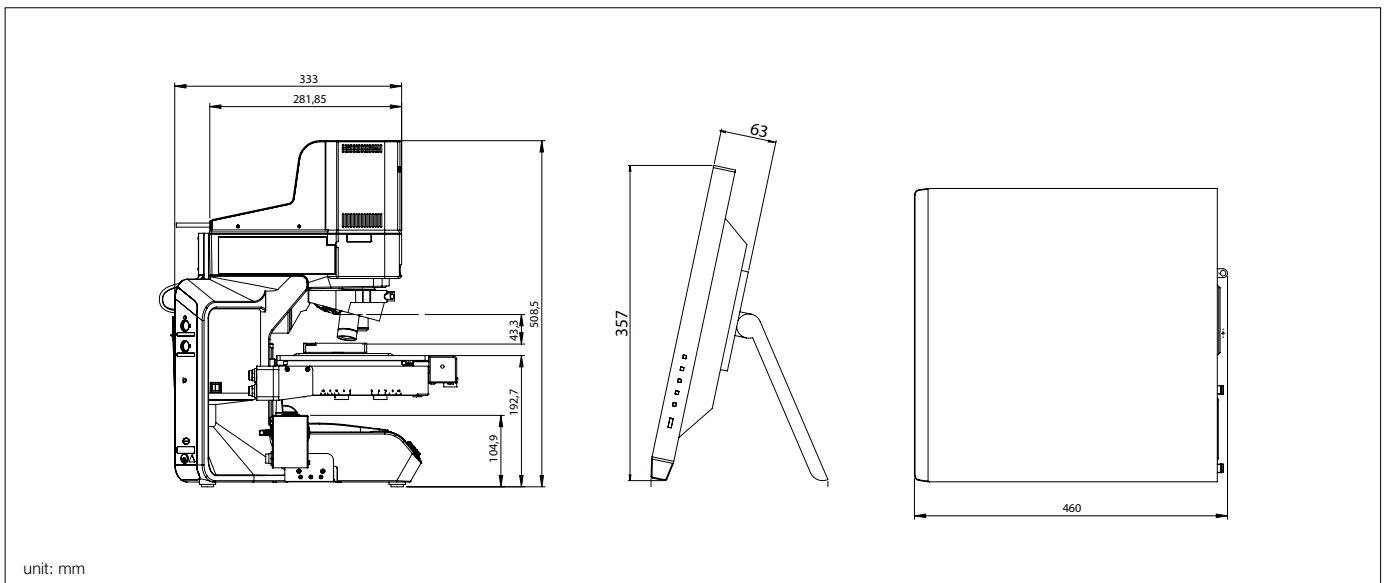
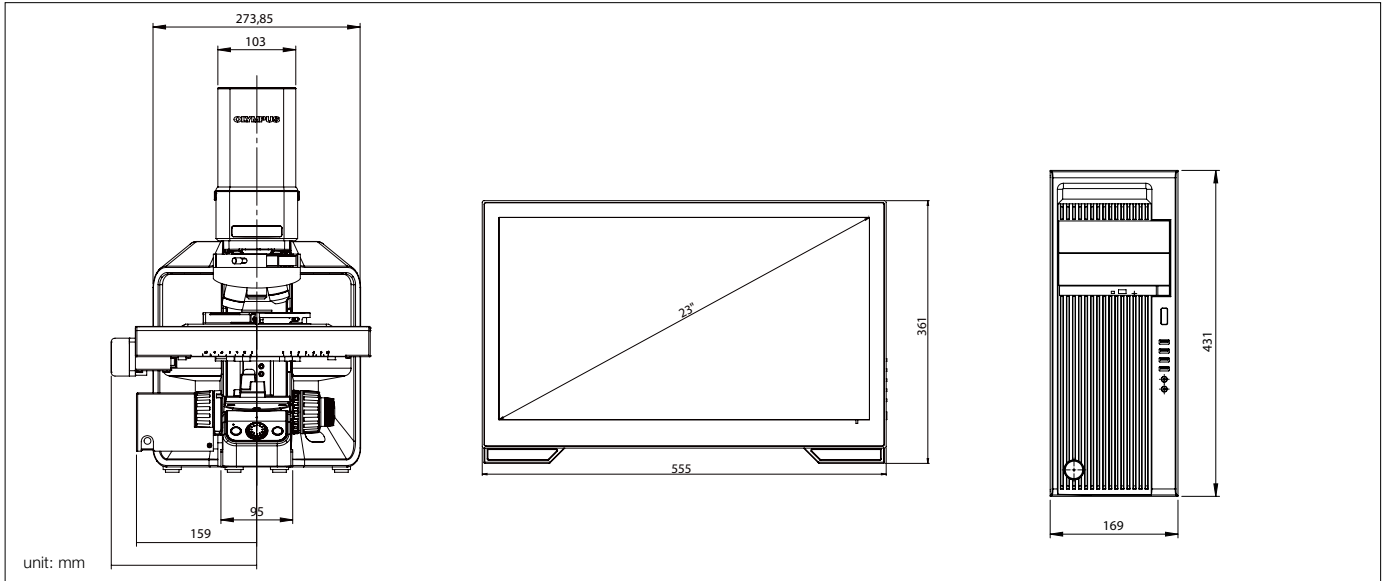

- OLYMPUS CORPORATION is ISO14001 certified.
- OLYMPUS CORPORATION is ISO9001 certified.
- All company and product names are registered trademarks and/or trademarks of their respective owners.
- Images on the PC monitors are simulated.
- Specifications and appearances are subject to change without any notice or obligation on the part of the manufacturer.

[www.olympus-ims.com](http://www.olympus-ims.com)

**OLYMPUS**<sup>®</sup>

**OLYMPUS CORPORATION**  
Shinjuku Monolith, 2-3-1 Nishi-Shinjuku, Shinjuku-ku, Tokyo 163-0914, Japan