

**OLYMPUS**<sup>®</sup>

Your Vision, Our Future

System Microscope

**BX63/BX53**

**BX3 Series**

A Clear Edge in Imaging





## A Revolutionary New Standard in Accuracy and Imaging Efficiency

Whether it is flexibility or easy operation, the user-friendly design of the BX3 series of Olympus microscopes lends itself to a wide range of settings for brightfield/darkfield and fluorescence imaging.

With multiple model choices and configurations options, there's a microscope for everyone that will meet individual needs — from routine to advanced imaging.



# INTELLIGENT DESIGN FOR EASE OF OPERATION AND EFFICIENT WORKFLOW

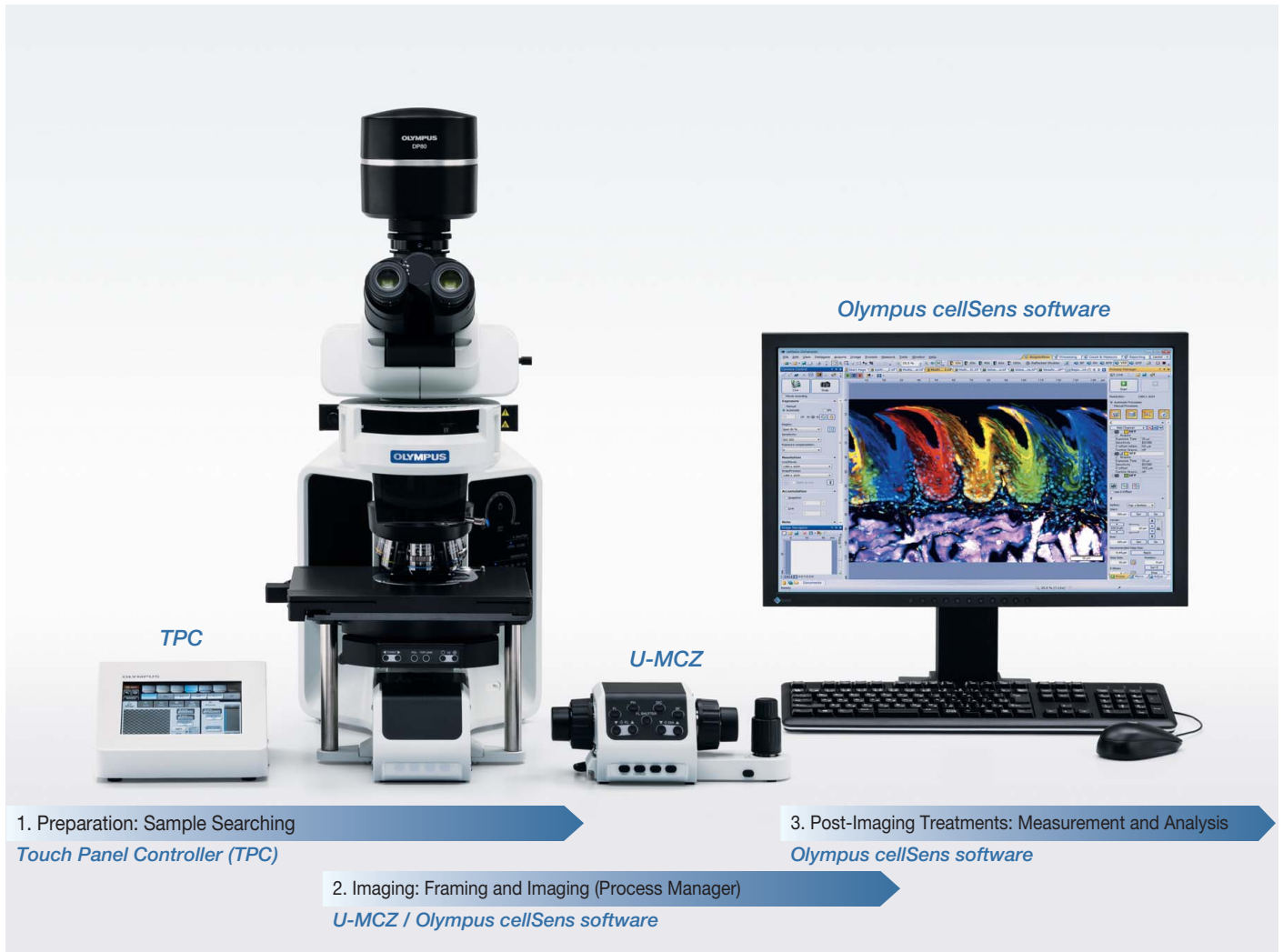

Never strain again to view live images with microscope adjustments. The BX63 and Olympus cellSens software\*, offers the flexibility to place the touch panel and U-MCZ remote microscope controller anywhere on the bench. Think speed and efficiency in image focusing and framing with the U-MCZ positioned by the monitor. Simple and quick switching between observation methods and magnifications is always a touch away.

The cellSens Process Manager automates multicolor, multipoint and other imaging methods from settings entered through the touch panel or directly into cellSens. After acquisition, image processing, measurement and analysis is complete with Olympus cellSens software.

## Effortless Imaging

\* cellSens software is not for clinical diagnostic use



### The Touch Panel Controller Places the Power of All Operations in a Single Fingertip

Switch between different observation methods and magnifications with a mere touch. The controller offers the choice of a Guidance Mode enabling navigation of procedures currently in use, and the Full Operations Mode that provides access to an entire range of settings—keep full control close at hand for prompt view of microscope system status. Furthermore, multiple observation points and conditions can be saved in advance, enabling rapid recall and reproduction of imaging conditions used by other researchers.



### The U-MCZ Controller Blends Rapid Framing and Focusing with Familiar Operational Feel

The U-MCZ controller can be detached from the microscope frame and positioned according to user. When used in combination with the XY controller that is provided with the ultrasonic stage, it delivers user-friendly focusing and framing operations that mimic a conventional microscope—all while live images in Olympus cellSens software are kept clearly in view. Switches are also conveniently located on the controller to enable switching between different observation methods, objectives, and mirror units while keeping the ability to simultaneously select intensity adjustments or image capture.

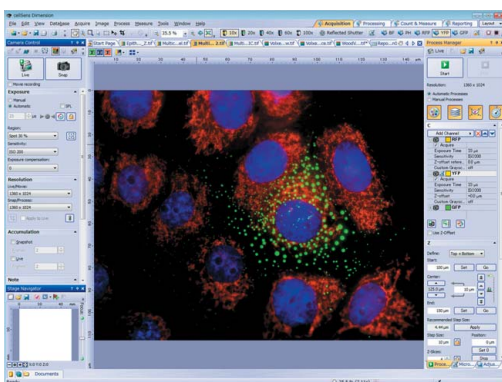

### Olympus cellSens Improves Efficiency in Imaging Procedure with its Process Manager and Workflow Optimization

Observation condition data can be set to the touch panel, U-MCZ, and XY controller, which are registered by the Olympus cellSens imaging software, while the Process Manager allows automation of multicolor image acquisition.



### Instantly Switch Between Color and Monochrome CCDs with the DP80 Microscope Digital Camera

Two different CCDs enable the handling of both monochrome and color imaging, with simple switching between the two CCDs available through handy touch screen operation or Olympus cellSens. Highly sensitive fluorescent images and high-definition brightfield images can thus be acquired from the same camera, eliminating the need to use another camera for high-sensitivity fluorescence imaging.

# TASK MANAGEMENT WITH LESS EFFORT

## Microscopy Research With a Personal Touch

With microscope optics pushing the boundaries of resolution at all magnifications and new microscope design — enabling techniques, it is important to be able to efficiently capture and process the images produced. In addition, an increasing number of researchers are using microscopy and it is therefore essential that imaging and analysis are both flexible and user-centric.

The Olympus cellSens software\* family fulfils all these requirements with its unique personalisation concept.

Solution	Each cellSens Package can be expanded towards a specific application by using optional "Solutions"
<b>Dimension</b>	available following solutions:
CI Deconvolution	Multiposition
Ratio	Well Plate Navigator
	Count & Measure
	Database Core
	Database Client
	NetCam
<b>Standard</b>	available following solutions:
Multichannel Acquisition	Manual Process
	Database Core
	Database Client
	NetCam
<b>Entry</b>	available following solution:
	Database Client

## Framing and Imaging (Process Manager)

### Multicolor

**Dimension** or **Standard** + **Multichannel Acquisition**

Simply select the desired observation conditions through a simple touch panel controller that automatically switches filters and acquires images as desired. When used in combination with multipoint capability, such functionality offers the ability to automatically acquire multicolor images over a wide area.

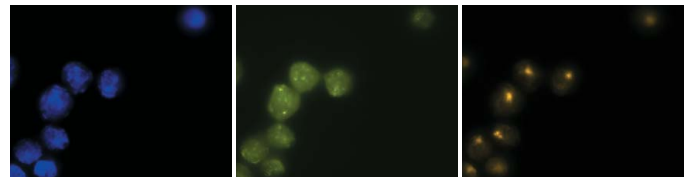

Multicolor: Imaging with Switched Excitation

### Z-Stack

**Dimension**

The Z-stack mode allows images to be captured along the Z-axis at a specified focus pitch. Use the U-MCZ to check the upper and lower focus limits of a specimen, and register these positions using the touch panel controller.

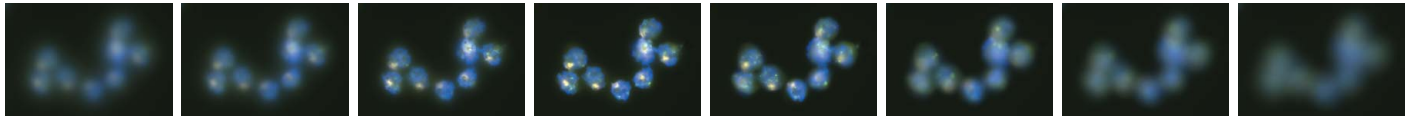

Z-Stack: Imaging with Varied Z-Plane

### Panoramic Imaging

**Dimension** + **Multiposition**  
or  
**Standard** + **Manual Process**

The manual multiple image alignment composes a single montage image while the specimen is scanned. Multiple saved images with adjoining components can also be combined into a single free-shape image. Wide area imaging can be completely automated when cellSens Dimension and its optional Multiposition Solution are combined with a motorized microscope.

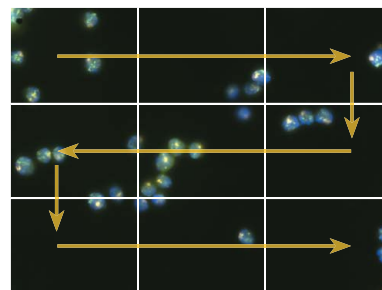

Panoramic Imaging (Tiling): Images are Accurately Stitched Together to Construct a Wide-Area Image

### Maximum Intensity Projection

The Maximum Intensity Projection mode creates a sharp, final all-focus image for thicker specimens.

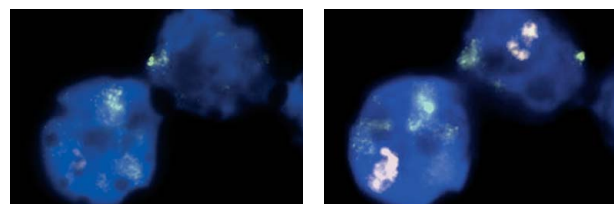

Original Image

Composite Image

Maximum Intensity Projection (Multicolored, All-Focus Composite Image): Composite Image Produced by Selecting the Brightest Signals from Multiple Images on the Z-Plane

\* cellSens software is not for clinical diagnostic use

## Experiment Manager

### EM (Experiment Manager)

Dimension

The Experiment Manager with a unique graphical user interface enables the formulation of even the most complex experimental procedures by simply dragging and dropping icons for the desired experiment commands onto the window.

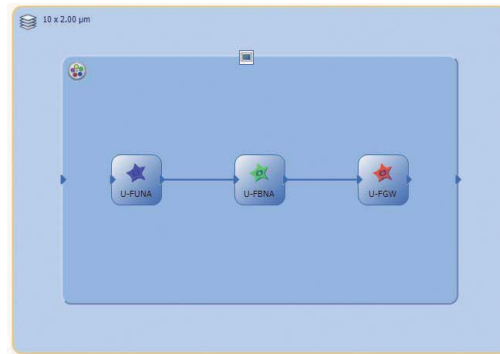

## Measurement and Analysis

### Manual Measurement

Dimension  
or  
Standard  
or  
Entry

Depending on the cellSens package different measurements are easily accessible, including distances, areas, intensity measurements and morphological parameters. Measurement data is saved as an image layer that can be exported to MS Excel and cellSens workbook formats, or viewed using OlyVia the free image viewer software.

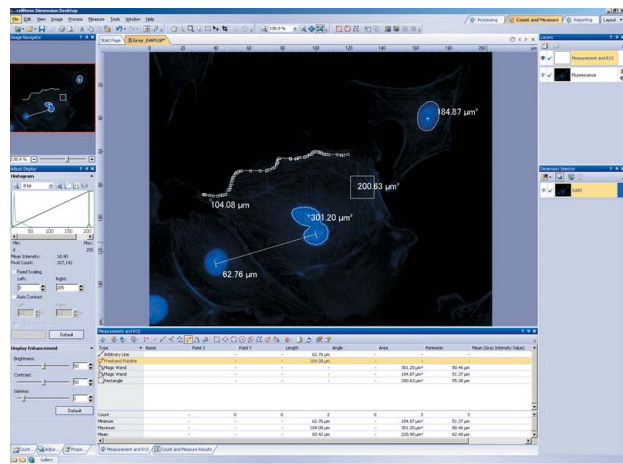

### Automatic Object Measurement and Classification

Dimension + Count & Measure

cellSens Dimension has an extensive set of manual measurements that can be further expanded with the Count & Measure Solution. Easily perform automatic object measurement and classification in an interactive interface where recognized objects are always linked with their measurements.

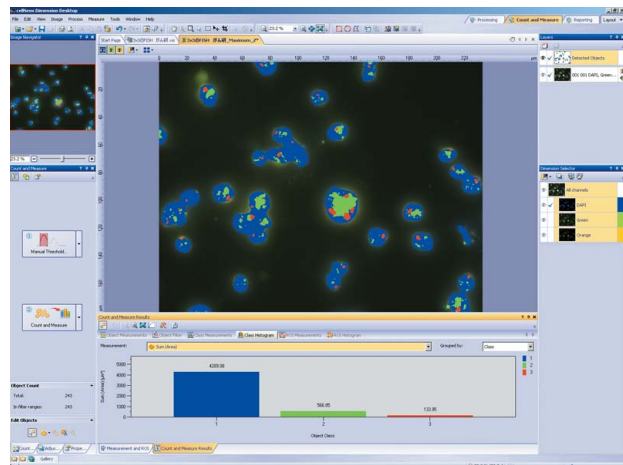
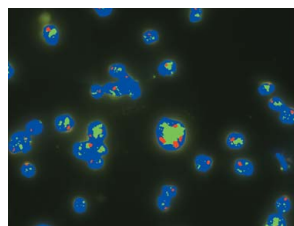
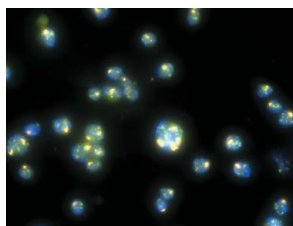

Original Image

Object Detected on Image

Measurement and Classification Results

## ADVANCED SENSITIVITY IN FLUORESCENCE IMAGING

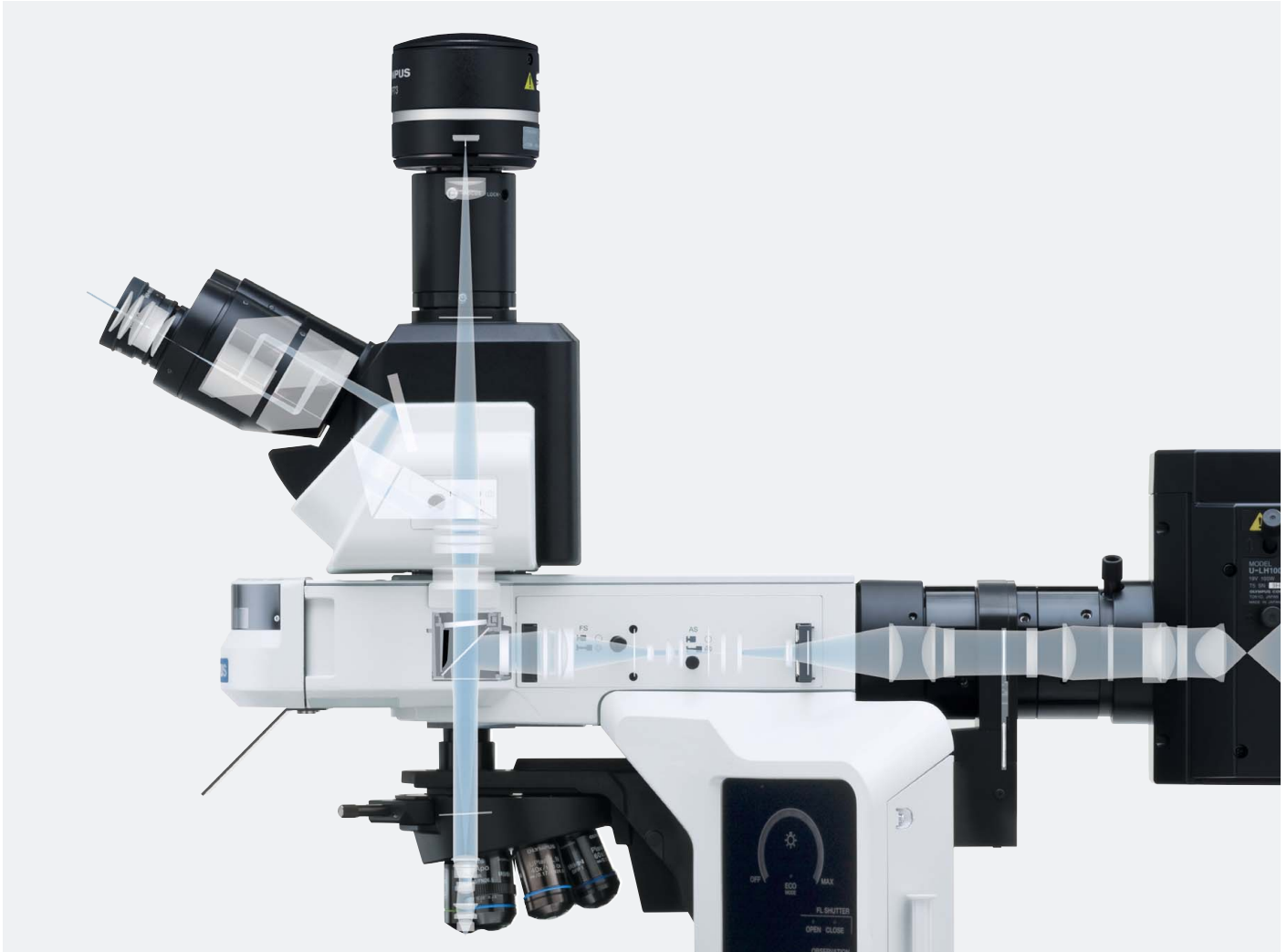

Higher signal-to-noise ratio (S/N) produces brighter and better fluorescence images, that's why Olympus has pushed the boundaries of S/N with improved fluorescence detection capacity. With mirror units, Olympus high transmission objectives, and fluorescence illuminators that incorporate a fly-eye-lens system, a brighter, more uniform illumination and detection is possible.

# Accuracy & Ease of Use



### New Fluorescence Illuminators with Fly-eye-lens system

Fluorescence illuminators BX3-RFAA and BX3-RFAS equipped with a Fly-eye-lens system provide uniform illumination. Even and uniform fluorescence illumination facilitates post-acquisition enhancements and processing.

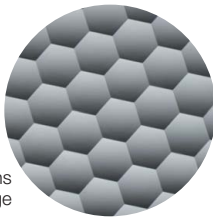

Surface of Fly-eye-lens system, Enlarged Image

### Fluorescence Mirror Units with the Latest Coating Technology

Olympus uses the latest coating technology to achieve outstanding performance to all fluorescence mirror units in order to produce high transmissions, sharp cut-offs and efficient detections of fluorescence.



### Further Flexibility in Fluorescence Integration

The Olympus 8-position fluorescence illuminator allows greater flexibility for a wide variety of fluorescence specimens with its easily exchangeable mirror units. Observations are accelerated further through the reduced need to replace mirror units for multicolor or FISH applications.

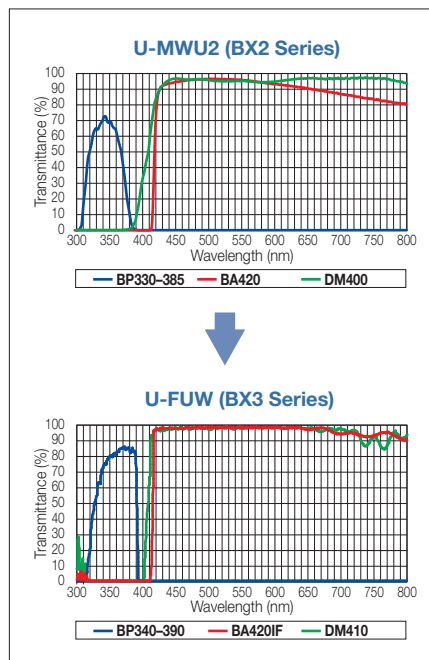

### Stray Light Reduction Equipped on All Mirror Units

The low reflection function eliminates stray light, producing a high S/N.

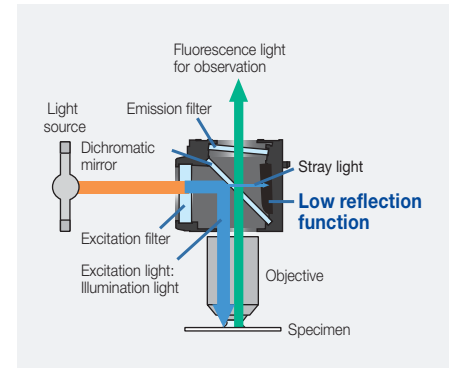

### High Transmission Objectives with Reduced Autofluorescence

Olympus UIS2 objectives are made with low-autofluorescence glass, anti-reflection coating, and lens joining materials, improving the S/N. Efficient detection of subtle fluorescence emissions even with weak excitation light deliver ideal performance in fluorescence imaging.



### Condenser Design to Reduce Back-Reflections

The motorized universal condenser is designed to reduce back-reflections and autofluorescence by swinging its top lens out, automatically closing its diaphragm to the minimum, and locating the wheel in between two positions in fluorescence imaging.



### Low Autofluorescence Immersion Oil

This immersion oil is specifically designed to reduce the autofluorescence normally associated with such oils, for improved S/N. Insusceptible to crystallization, it is an ideal oil for long time observations.



# INTELLIGENT DESIGN FOR FLEXIBLE CONFIGURATIONS AND OPERATING EASE



Intelligent Microscope BX63  
+ Digital Camera DP80  
+ cellSens software

Put simply, the BX63 is a motorized, intelligent microscope developed in response to the requests of hundreds of researchers and microscope users. With a simple touch, users can operate with a high speed of control through the detachable and freely positional U-MCZ controller or alternately, by means of a computer installed with cellSens imaging software\*.

All microscope data captured via control of the touch panel or U-MCZ controller are continually fed back through cellSens, giving users the freedom to operate the microscope in the most convenient manner for the task at hand.

From image capture to report creation, Olympus cellSens personalizes researchers' individual operational environments in accordance with individual researcher workflows.

## BX63

### Stability for Improved Imaging Reliability

By having a motorized nosepiece focusing system in combination with a fixed stage eliminates all sources of vibrations, further advancing the quality of image acquisition.

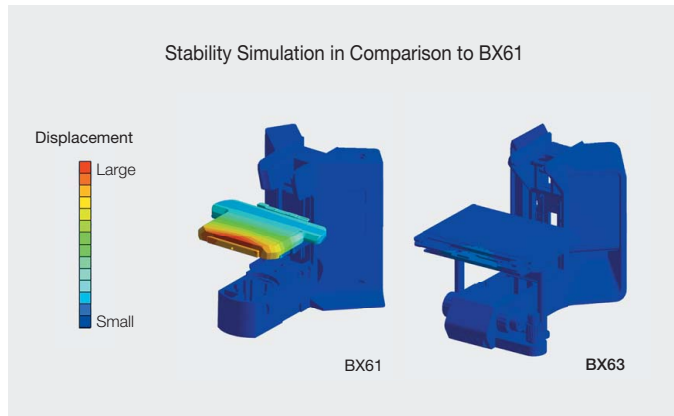

### Microscope Frame Equipped with Motorized Focus and Field Diaphragm

This unit incorporates a high-speed, high precision motorized focusing nosepiece with 0.01 $\mu$ m resolution and 20mm vertical strokes. The field diaphragm adjustment of transmitted light is also motorized.



### Motorized Fluorescence Illuminator/BX3-RFAA

The flexibility of the motorized fluorescence illuminator accommodates multicolor stained specimens. The 8-position mirror units permit quick tool-less changeover of fluorescence colors.



### Motorized Attenuator Wheel/U-AW

The Olympus BX63 has a motorized ND filter wheel for fluorescence and transmitted light intensity adjustments. Special adapters are required for mounting (U-LHEAD for fluorescence, and U-LH100ADP for transmitted light).



### Motorized Seven Position Nosepiece/U-D7REA

This revolving nosepiece allows simultaneous attachment of seven objectives. It is especially suitable for continuous observations from low to high magnifications and combining specific objectives, such as polarized light observations.



### Motorized Universal Condenser/BX3-UCD8A

By integrating with designated optical components, the motorized universal condenser accommodates various kinds of transmitted light observation, from brightfield to differential interference contrast and phase contrast.



### Ultrasonic Stage/BX3-SSU

The ultrasonic stage delivers high-precision XY control. The XY-controller can be mounted on the controller/U-MCZ for the BX63 and worked like conventional stage handles.



## SYSTEM FLEXIBILITY WITH COMFORTABLE OPERABILITY



The BX53 is a versatile system microscope that can be configured to meet virtually any research need. It supports a wide range of fluorescence imaging applications, and has a range of advanced features for enhanced operating ease and process flexibility.

# BX53

### Customizable Control Layout

Light intensity now can be controlled with the dial in front, and transmitted filters and fluorescence shutters are operable from either side. Detachable fine focus handle can be attached on either side of the microscope based on operator preference. The BX53 frees the operator to create a customized working environment with the microscope.



### Further Ease in Imaging with Multi-Stained Specimens

The 8-position fluorescence illuminator allows flexible responses to various fluorescence specimens. Mirror units can easily be replaced.



### Automatic Switching of DIC Prisms

Switching objectives on the motorized or coded 7-position revolving nosepiece, integrated with the motorized universal condenser, enables an automatic switch to the optimal DIC prism. Simplified prism switches accelerate observations.



Changing Objectives with Coded Nosepiece, Automatic Switchovers of DIC Elements

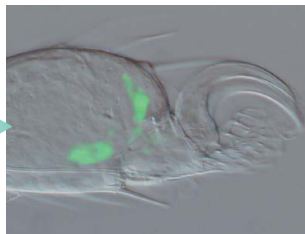

Optimum Contrast Observation

### Quick Changeover of Observation Methods

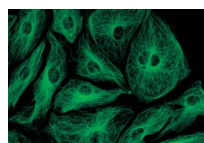

Fluorescence

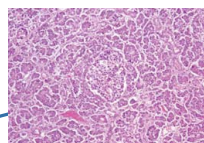

Brightfield

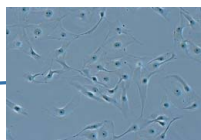

Phase Contrast

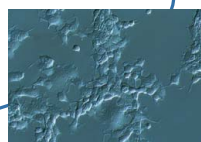

Nomarski DIC

### Saves Microscope Information with Coded Units

cellSens imaging software integrates with the coded and motorized components to automatically store fluorescence mirror unit and objective data with the images, facilitating post-imaging treatments.

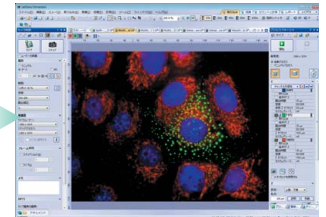

cellSens Imaging Software

### Energy Saving Switch Turns Off Light Source Automatically

The motion sensor detects when an operator is present and when absent, automatically turns off the transmitted light lamp after 30 minutes. The energy saving switch conserves energy and extends lamp lifetime.



System Microscope BX53

# OPTIMAL PERFORMANCE WITH WIDE WAVELENGTH SPECTRUM



**UIS2**  
World-leading optics

## UPLSAPO Series

Thanks to the application of the original Olympus UW multi-coatings, these Super Apochromat objectives compensate for both spherical and chromatic aberrations from the UV to the near infrared region. Their sensitivity to fluorescence emissions ensures the acquisition of sharp, clear images, without color shift, even in brightfield and Nomarski DIC observations. For quality and performance, they offer solutions for digital imaging needs.



# Objectives

## UIS2 objectives

Objective	NA	W.D. (mm)	FN	Cover glass thickness (mm)	Immer-sion	Spring	Cor-rection ring	Iris dia-phragm	Water proof and oil proof function
UPLSAPO 4X	0.16	13	26.5	—					
UPLSAPO 10X2	0.40	3.1	26.5	0.17					
UPLSAPO 20X	0.75	0.6	26.5	0.17		✓			
UPLSAPO 20XO	0.85	0.17	26.5	—	Oil	✓			✓
UPLSAPO 30XS	1.05	0.8	22	0.13-0.19	Silicone		✓		✓
UPLSAPO 30XSIR	1.05	0.8	22	0.13-0.19	Silicone		✓		✓
UPLSAPO 40X2	0.95	0.18	26.5	0.11-0.23		✓	✓		
UPLSAPO 40XS	1.25	0.3	22	0.13-0.19	Silicone	✓	✓		✓
UPLSAPO 60XW	1.20	0.28	26.5	0.13-0.21	Water	✓	✓		✓
UPLSAPO 60XO	1.35	0.15	26.5	0.17	Oil	✓			✓
UPLSAPO 60XS2	1.30	0.3	22	0.15-0.19	Silicone	✓	✓		✓
UPLSAPO 100XO	1.40	0.13	26.5	0.17	Oil	✓			✓
UPLSAPO 100XS	1.35	0.2	22	0.13-0.19	Silicone	✓	✓		✓
UPLSAPO 100XOPH	1.40	0.12	26.5	0.17	Oil	✓			✓
PLAPON 1.25X	0.04	5	26.5	—					
PLAPON 2X	0.08	6.2	26.5	—					
PLAPON 60XO	1.42	0.15	26.5	0.17	Oil	✓			✓
PLAPON 60XOSC2	1.40	0.12	22	0.17	Oil	✓			✓
PLAPON 60XOPH	1.42	0.15	26.5	0.17	Oil	✓			✓
UPLFLN 4X	0.13	17	26.5	—					
UPLFLN 10X2	0.30	10	26.5	—					
UPLFLN 20X	0.50	2.1	26.5	0.17		✓			
UPLFLN 40X	0.75	0.51	26.5	0.17		✓			
UPLFLN 40XO	1.30	0.2	26.5	0.17	Oil	✓			✓
UPLFLN 60X	0.90	0.2	26.5	0.11-0.23		✓	✓		
UPLFLN 60XOI	1.25-0.65	0.12	26.5	0.17	Oil	✓		✓	✓
UPLFLN 100XO2	1.30	0.2	26.5	0.17	Oil	✓			✓
UPLFLN 100XOI	1.3-0.6	0.2	26.5	0.17	Oil	✓		✓	✓
UPLFLN 10X2PH	0.30	10	26.5	—					
UPLFLN 20XPH	0.50	2.1	26.5	0.17		✓			
UPLFLN 40XPH	0.75	0.51	26.5	0.17		✓			
UPLFLN 60XOIPH	1.25-0.65	0.12	26.5	0.17	Oil	✓		✓	✓
UPLFLN 100XO2PH	1.30	0.2	26.5	0.17	Oil	✓			✓

Objective	NA	W.D. (mm)	FN	Cover glass thickness (mm)	Immer-sion	Spring	Cor-rection ring	Iris dia-phragm	Water proof and oil proof function
UPLFLN 4XP	0.13	17	26.5	—					
UPLFLN 10XP	0.30	10	26.5	—					
UPLFLN 20XP	0.50	2.1	26.5	0.17		✓			
UPLFLN 40XP	0.75	0.51	26.5	0.17		✓			
UPLFLN 100XOP	1.30	0.2	26.5	0.17	Oil	✓			✓
PLFLN 100X	0.95	0.2	26.5	0.14-0.2		✓	✓		
PLN 2X	0.06	5.8	22	—					
PLN 4X	0.10	18.5	22	—					
PLN 10X	0.25	10.6	22	—					
PLN 20X	0.40	1.2	22	0.17		✓			
PLN 40X	0.65	0.6	22	0.17		✓			
PLN 50XOI	0.90-0.50	0.2	22	—	Oil	✓		✓	✓
PLN 100XO	1.25	0.15	22	—	Oil	✓			✓
PLN 10XPH	0.25	10.6	22	—					
PLN 20XPH	0.40	1.2	22	0.17		✓			
PLN 40XPH	0.65	0.6	22	0.17		✓			
PLN 100XOPH	1.25	0.15	22	—	Oil	✓			✓
PLN 4XP	0.10	18.5	22	—					
ACHN 10XP	0.25	6	22	—					
ACHN 20XP	0.40	3	22	0.17					
ACHN 40XP	0.65	0.45	22	0.17		✓			
ACHN 100XOP	1.25	0.13	22	—	Oil	✓			✓
MPLAPON 60X	0.90	0.4	26.5	0		✓			
MPLAPON 100X	0.95	0.3	26.5	0					
MPLAPON 100XO	1.40	0.1	26.5	0	Oil	✓			✓
MPLFLN 2.5X	0.08	10.7	26.5	—					
MPLFLN 10X	0.30	11	26.5	—					
MPLFLN 20X	0.45	3.1	26.5	0					
MPLFLN 40X	0.75	0.63	26.5	0					
MPLFLN 100X	0.90	1	26.5	0					
MPLN 5X	0.10	20	22	—					
UAPON 20XW340	0.70	0.35	22	0.17	Water	✓			✓
UAPON 40XO340-2	1.35	0.1	22	0.17	Oil	✓			✓
UAPON 40XW340	1.15	0.25	22	0.13-0.25	Water	✓	✓		✓

## UPLFLN (UPLFLN-PH) Series

These Plan objectives also provide flat images with high transmission up to the near infrared region of the spectrum. With their high S/N, excellent resolution and high contrast imaging, they are especially effective in brightfield and Nomarski DIC observations. The UPLFLN-PH series is optimized for phase contrast observation.



## PLAPON Series

Designed for optimum resolution and contrast, these Plan Apochromat objectives keep chromatic aberration to a minimum. The PLAPON60xOSC objective has two improvements, chromatic aberration compensation at 405nm – 650nm and image-forming performance at 405nm.



## PLN Series

Ideal for a range of biological applications, these high quality objectives feature excellent flatness up to FN 22 in transmitted brightfield (phase contrast) observation. The PLN-PH series is specifically designed for phase contrast work.



# WORLD-RENOWNED OPTICAL PERFORMANCE ACCOMMODATES VARIOUS OBSERVATION METHODS

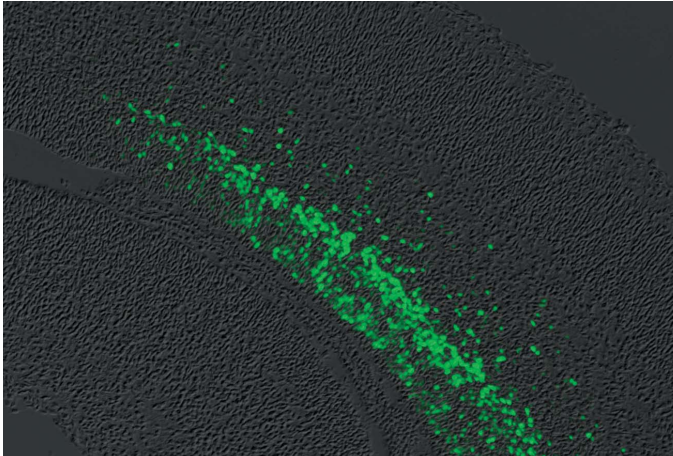

Brain Section of Mouse at Embryonic Day 15 (GFP)

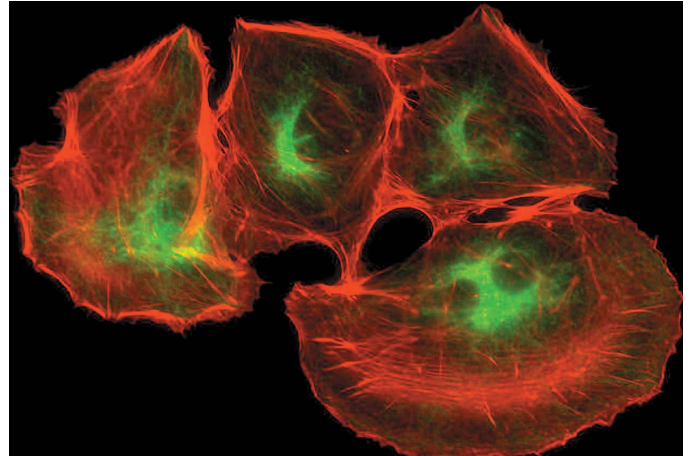

NRK-52E Cells (Alexa Fluor 488/Alexa Fluor 546)

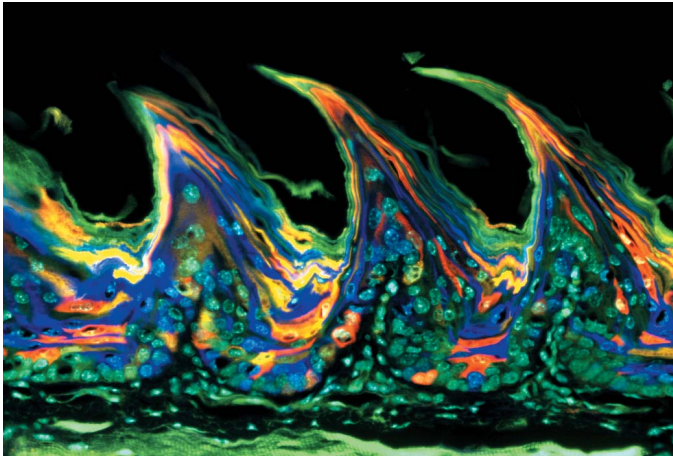

Rainbow mouse (Each interpapillary pit of the tongue is occupied by single-color cells that originate from monoclonal stem cells.) Two days after tamoxifen induction, the epithelial cells in the interpapillary pit express random colors, indicating that multiple clones proliferated independently. However, after 84 days, each interpapillary pit was occupied by single-color cells, indicating that they are derived from monoclonal stem cells. (Nature Cell Biology 15, 511–518, 2013)

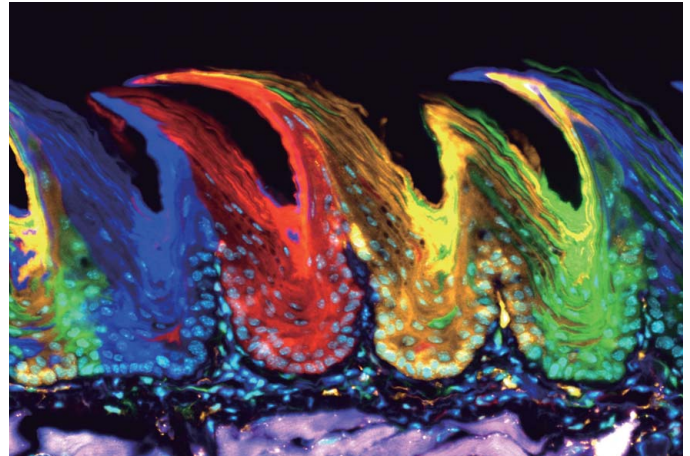

## Fluorescence

### Olympus Takes Fluorescence Observation to Another Plane

The U-HGLGPS light source is a pre-centered liquid light guide illuminator, equipped with a liquid light guide that suppresses the impact of lamp heat on the microscope and specimens alike. Employing a high-pressure mercury bulb, the light source offers a durable average lifetime of 2000 hours and a more stable and even illumination.



U-HGLGPS (Light Guide Illumination System)

A total of three types of reflected illuminators are available: motorized fluorescence illuminator BX3-RFAA; coded fluorescence illuminator BX3-RFAS; universal reflected illuminator BX3-URA. Storing fluorescence mirror unit data (used in imaging) together with the images is possible by integrating coded fluorescence illuminator or motorized fluorescence illuminator with cellSens software.



# Observation Methods



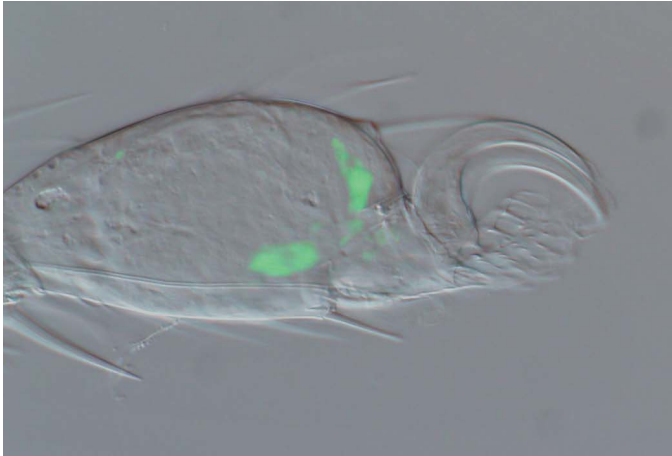

Distal Tip of a *Drosophila* limb (GFP)

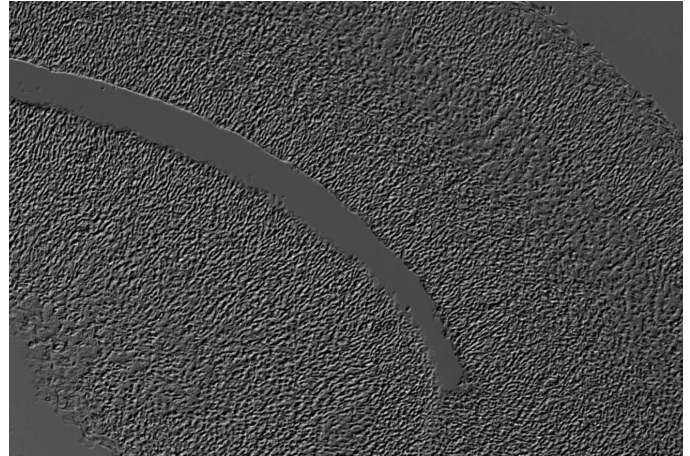

Brain Section of Mouse at Embryonic Day 15

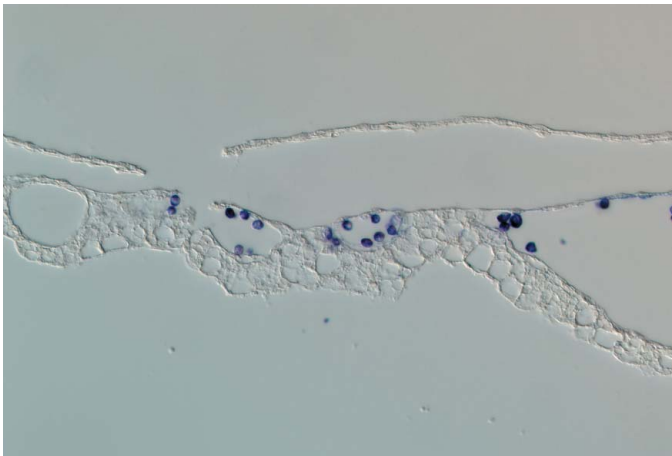

Blood Island at Stage 12 of Chicken Development

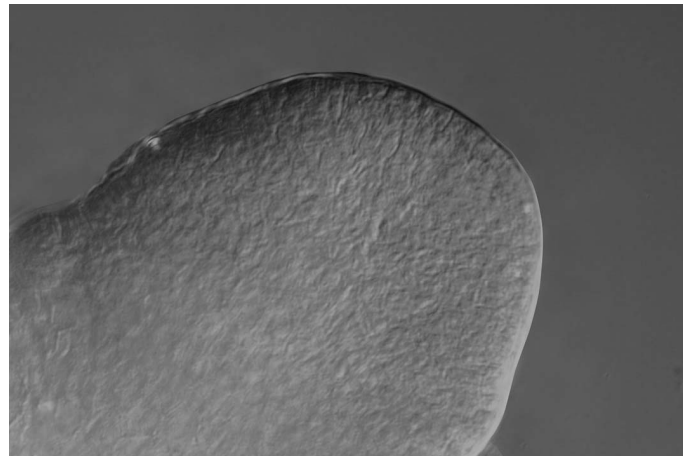

A Shoot Apical Meristem of Rice

## Nomarski DIC

### Image Optimization According to Specimen Characteristics

Olympus has prepared a wide selection of DIC sliders with varied shearing value for acquiring optimal specimen images. The U-DICT and the U-DICTS are designed for all-round performance. The U-DICTHC optimizes high-contrast observations of thin specimens, and the U-DICTHR, high resolution with less glare for thick specimens.



① U-DICT ② U-DICTS ③ U-DICTHR ④ U-DICTHC

Two types of condensers are also available: 8-position universal condenser U-UCD8-2; motorized universal condenser BX3-UCD8A, both for various observations (brightfield, darkfield, phase contrast, DIC and simple polarized light).



## Brightfield

### Brighter Images, with Superb Resolution/Flatness at All Magnifications

A diverse condenser lineup includes: the achromatic aplanatic U-AAC delivering excellent resolution and flatness from low to high magnifications; the swing-out U-SC3 accommodating 1.25x to 100x objectives; the low magnification U-LC for continuous 2x to 100x (Dry) observations; the ultra low magnification U-ULC-2.



① U-SC3 ② U-ULC-2 ③ U-AC2 ④ U-AAC ⑤ U-LC

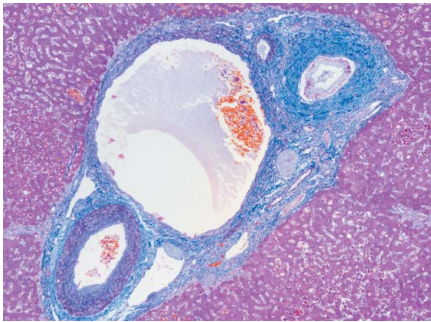

Liver (Azan Stain)

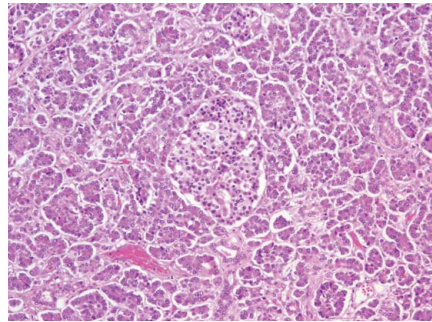

Pancreas (HE Stain)

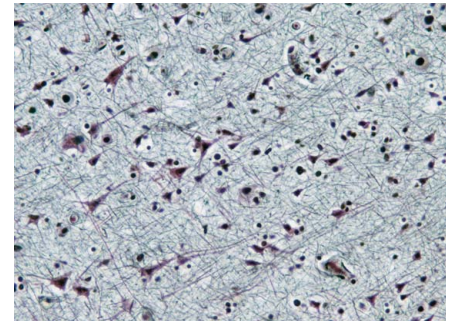

Cerebrum (Bodian Stain)

## Phase Contrast

### Ideal Phase Contrast Observation with Excellent Image Clarity

High contrast phase imaging allows close observation of the cell interior and of live bacteria. Using UPLFLN-PH or PLN-PH series objectives, phase contrast observation from 10x up to 100x is achievable. With the U-PCD2 phase/darkfield condenser, users can view specimens in brightfield or darkfield. Simultaneous observation with reflected light fluorescence microscopy is also possible.



U-PCD2

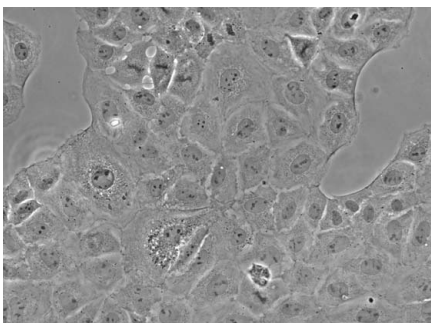

NRK-52E Cells

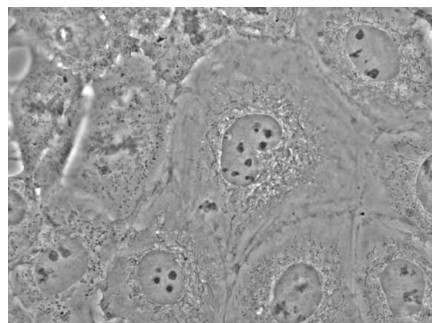

NRK-52E Cells

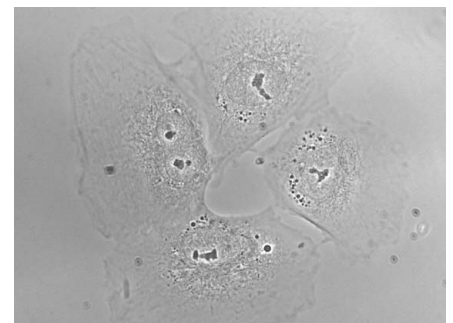

NRK-52E Cells

## Polarized Light

### Polarizing Observation for Wide-Area Retardation Measurement

Tooth, bone, muscle tissue, nerve tissue, actomyosin fiber and mitotic spindle can all be observed, without staining. There are intermediate attachments (U-OPA/U-CPA) for orthoscopic and orthoscopic/conoscopic viewing. Various compensators make it possible to observe a wide range of retardation. Also available is a condenser exclusively for polarization observation, revolving nosepiece, rotating stage, objectives and simple polarizing attachment.



①U-POC-2 ②U-CPA ③U-OPA ④U-AN360P-2  
⑤U-P4RE ⑥U-GAN ⑦U-POT

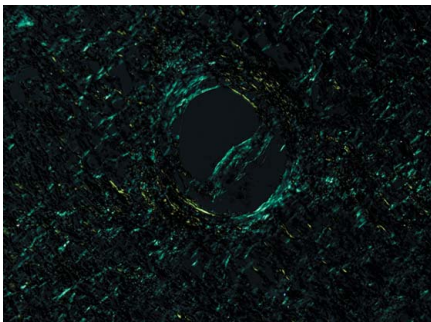

Amyloid

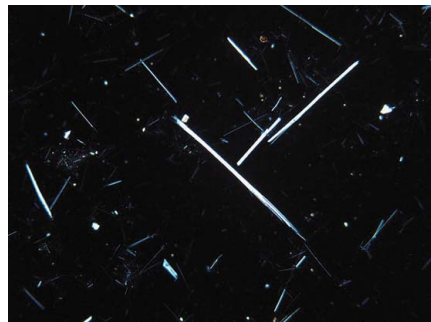

Asbestos



Urate crystals

## Darkfield

### High-Quality Darkfield Effect at All Magnifications

Two darkfield condensers are provided: the dry darkfield condenser (U-D CD), for magnifications from 10x to 100x (up to NA 0.80); and the oil immersion darkfield condenser (U-DCW), for magnifications from 20x to 100x (up to NA 1.2).

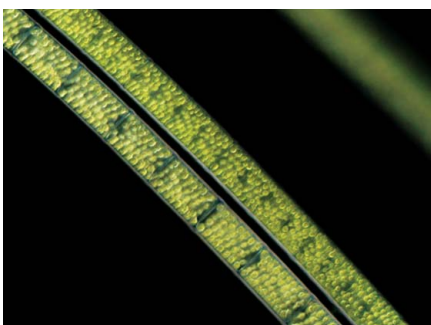

Spirogyra



Water Flea

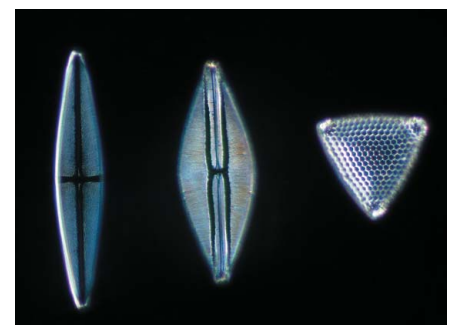

Diatom

# MICROSCOPE DIGITAL CAMERAS TO FULFILL DIVERSE NEEDS

## Digital Cameras

### DP80

#### A Cutting-Edge Digital Microscopy Camera Equipped with Dual CCD Sensors, Providing Both High Sensitivity Monochrome and High-Quality Single-Shot Color Images with Pixel Precision

The DP80 boasts the innovative advantage of allowing the acquisition of both high-sensitivity fluorescence images and high-quality brightfield images simply by switching between two CCDs depending on the observation method needed. The high-sensitivity monochrome CCD provides images of weak fluorescent light, while the color CCD acquires brightfield images (up to 12.5 million pixels) with high color reproduction faithful to the visual microscope observation. DP80 CCD sensor are pre-calibrated at production time: no user intervention is necessary to superimpose color and monochrome images with pixel precision. The excellent imaging performance is an advantage in creating presentations or scientific publications.

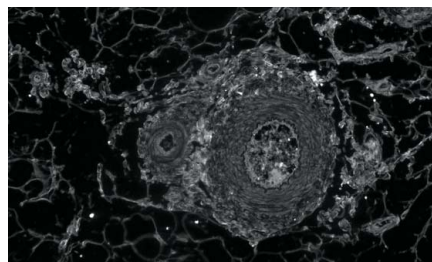

BW Image

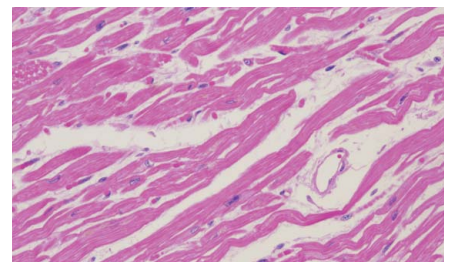

Brightfield Image

### DP73

#### Supports High-Quality Fluorescence Imaging, with an Excellent Resolution and Color Reproduction

The DP73 displays live digital images with gradual smoothness and combines exceptional resolution with precise color reproduction. It also offers outstanding operational ease, even when focusing and moving the observation site, to deliver a feel similar to viewing an image directly through the microscope. Furthermore, the DP73 supports the creation of digital brightfields and fluorescence documentation, and has conference presentation capability, to provide unrivalled value from the first use.



### DP27

#### Capture Brightfield Images with Exceptional Detail

Equipped with an exceptional 5.05-megapixel CCD, the DP27 digital camera captures images at up to 2448 x 1920 pixel resolution. Large areas captured at low magnification offer exceptionally vivid clarity, even when enlarged several times. Precise reproduction of fine structures and subtle color differences allows targets on the monitor to be identified with an accuracy equivalent to observation through microscope. The DP27 is also available in a completely stand-alone configuration, with no need for a computer and software.



## DP22

### The Optimal Stand-Alone Model for Conferences

The DP22 is a stand-alone digital camera for simple operations from observations to imaging. Its color reproduction near unaided microscopic observation and smooth, high-definition live image displays are appropriate for discussion groups and conferences. Optional cellSens imaging software platform also allows computer operation.



## Accessories

### Camera Adapters

The single port tube of the trinocular tube is detachable, and can be used with various cameras through a range of adapters.

Camera Adapter (projection lens)	Projection Magnifications	Projection Area (FN)		
		2/3" CCD	1/2" CCD	1/3" CCD
U-TV1XC	1x	11	8	6
U-TV1X-2+U-CMAD3	1x	11	8	6
U-TV1X-2+U-BMAD	1x	11	8	6
U-TV0.63XC	0.63x	17.5	12.7	9.5
U-TV0.63XB	0.63x	17.5	12.7	9.5
U-TV0.5XC-3	0.5x	22	16	12
U-TV0.35XC-2	0.35x	—	22	17.1

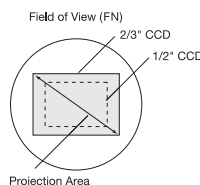

$$\text{Practical Field of View (mm)} = \frac{\text{Projection Area (field number)}}{\text{Objective Magnifications}}$$

### Eyepieces

Eyepieces maintain image flatness when a reflected light illuminator or other intermediate tube is attached. The two available types are FN 22 and FN 26.5.

Item	Name	FN	Diopter	Micrometer (ømm)
Widfield	WHN10X	22		24
	WHN10X-H	22	-8 — +5	24
	CROSSWHN10X	22	-8 — +5	
Super widefield	SWH10X-H	26.5	-8 — +2	—
	MICROSSWH10X	26.5	-8 — +2	
	CROSSSWH10X	26.5	-8 — +2	



### Observation Tubes/Eyepoint Adjusters

A wide range of observation tubes is available for the BX3 series, including wide field binocular, trinocular types, various tilting tubes, tilting, telescopic, lifting binocular tube, and tubes for observation of upright images in which the specimen and the observed image move in the same direction.



- ①U-TTBI/U-ETBI ②U-TTLBI ③U-TTR-2 ④U-SWETTR-5 ⑤U-BI30-2 ⑥U-TBI-3  
⑦U-TR30/U-TR30NIR ⑧U-SWTR-3 ⑨U-TBI-3-CLI ⑩U-ETR-4 ⑪U-EPA2 ⑫U-EPAL-2

**BX63 system diagram**

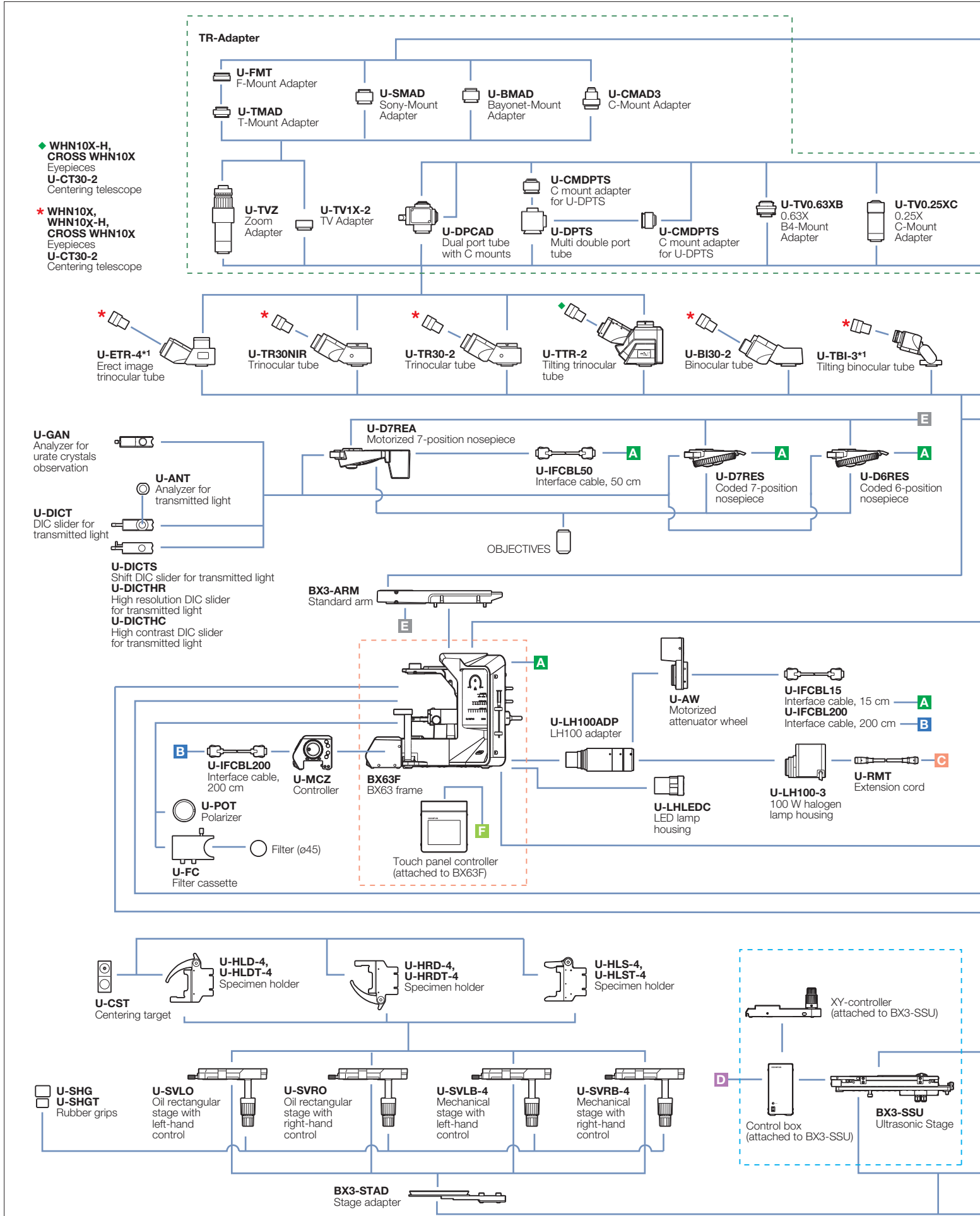

◆ WHN10X-H, CROSS WHN10X  
Eyepieces  
U-CT30-2  
Centering telescope

\* WHN10X, WHN10X-H, CROSS WHN10X  
Eyepieces  
U-CT30-2  
Centering telescope

**U-GAN**  
Analyzer for urate crystals observation

**U-DICT**  
DIC slider for transmitted light

**U-DICTS**  
Shift DIC slider for transmitted light  
**U-DICTHR**  
High resolution DIC slider for transmitted light  
**U-DICTHC**  
High contrast DIC slider for transmitted light

**U-CST**  
Centering target

**U-SHG**  
**U-SHGT**  
Rubber grips

\*1 Slight vignetting may occur in combination with an additional intermediate attachment or fluorescence illuminator. \*2 Require an additional intermediate attachment or fluorescence illuminator.

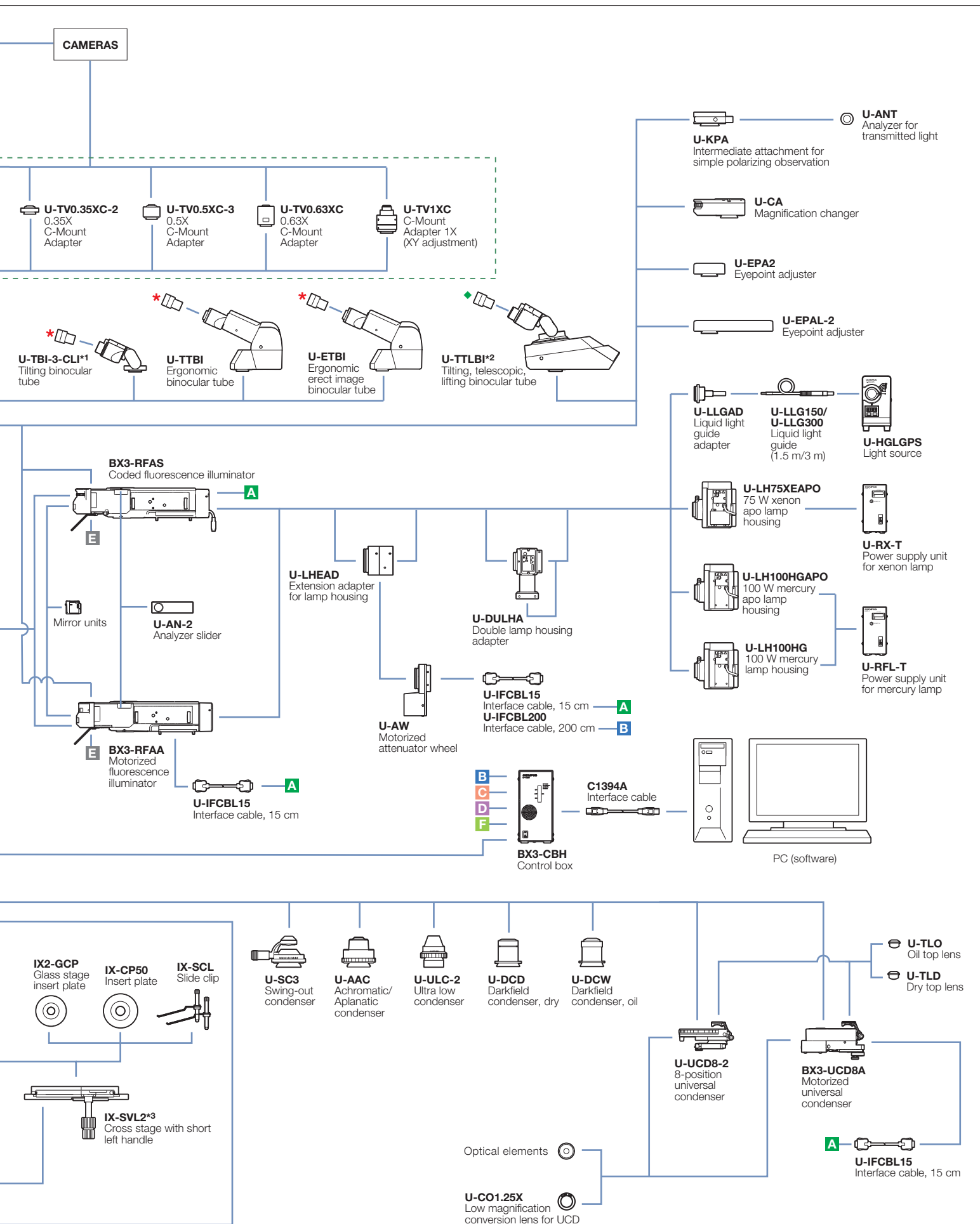

\*3 Cannot be used with BX3-UCD8A and U-UCD8-2

**BX53 system diagram**

◆ **WHN10X-H, CROSS SWH10X**  
Eyepieces  
**U-CT30-2**  
Centering telescope

\* **WHN10X, WHN10X-H, CROSS WHN10X**  
Eyepieces  
**U-CT30-2**  
Centering telescope

▲ **SWH10X-H, CROSS SWH10X, MICRO SWH10X**  
Eyepieces  
**U-CT30-2**  
Centering telescope

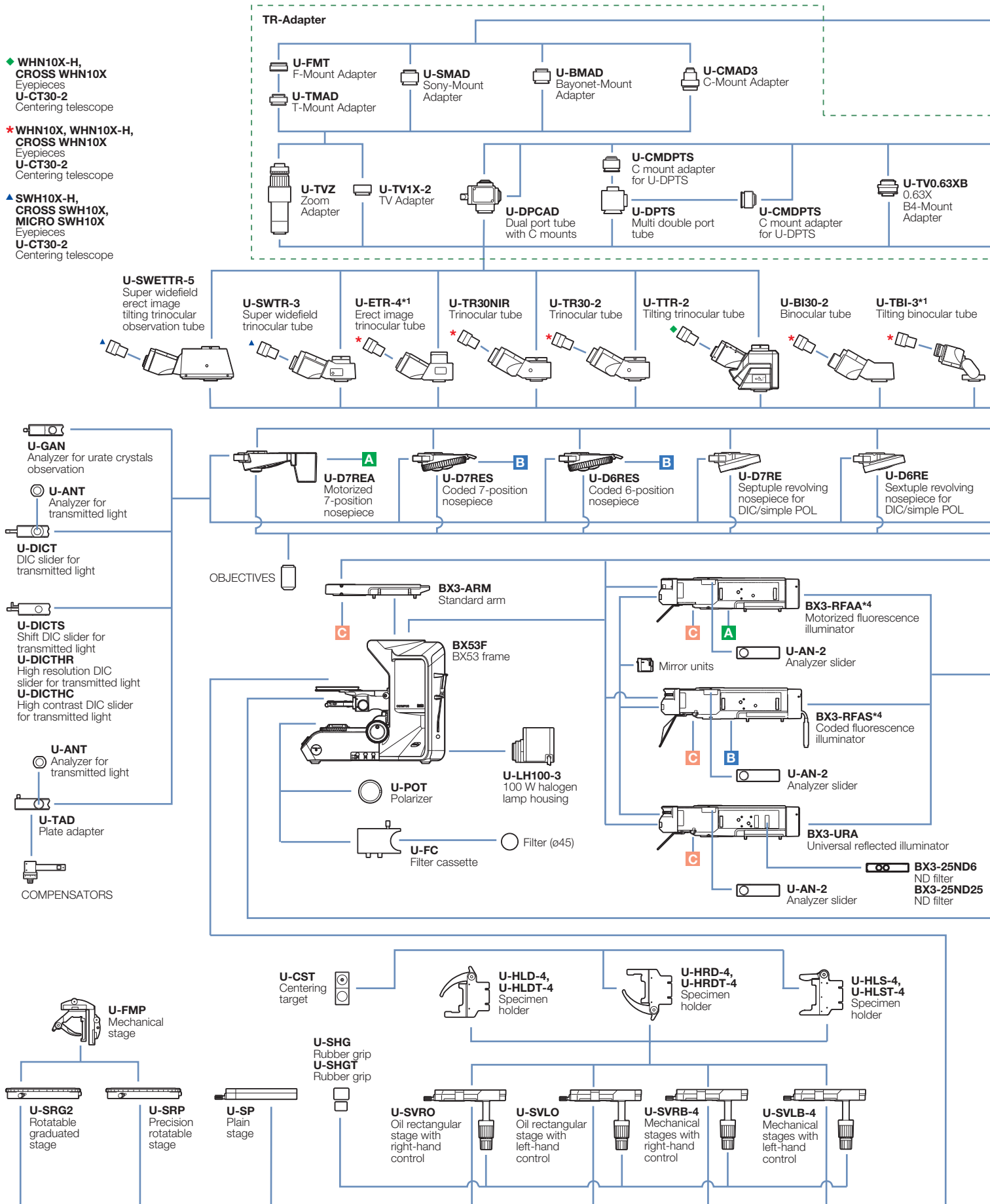

\*1 Slight vignetting may occur in combination with an additional intermediate attachment or observation method. \*2 Require an additional intermediate attachment or fluorescence illuminator.  
\*3 Cannot be used with U-TTLBI. \*4 Compatible with FN 22. \*5 Cannot be used with BX3-URA. \*6 Stand is a standard equipment of the U-MDOVS and U-MDO10R3. \*7 An auxiliary lens is equipped.



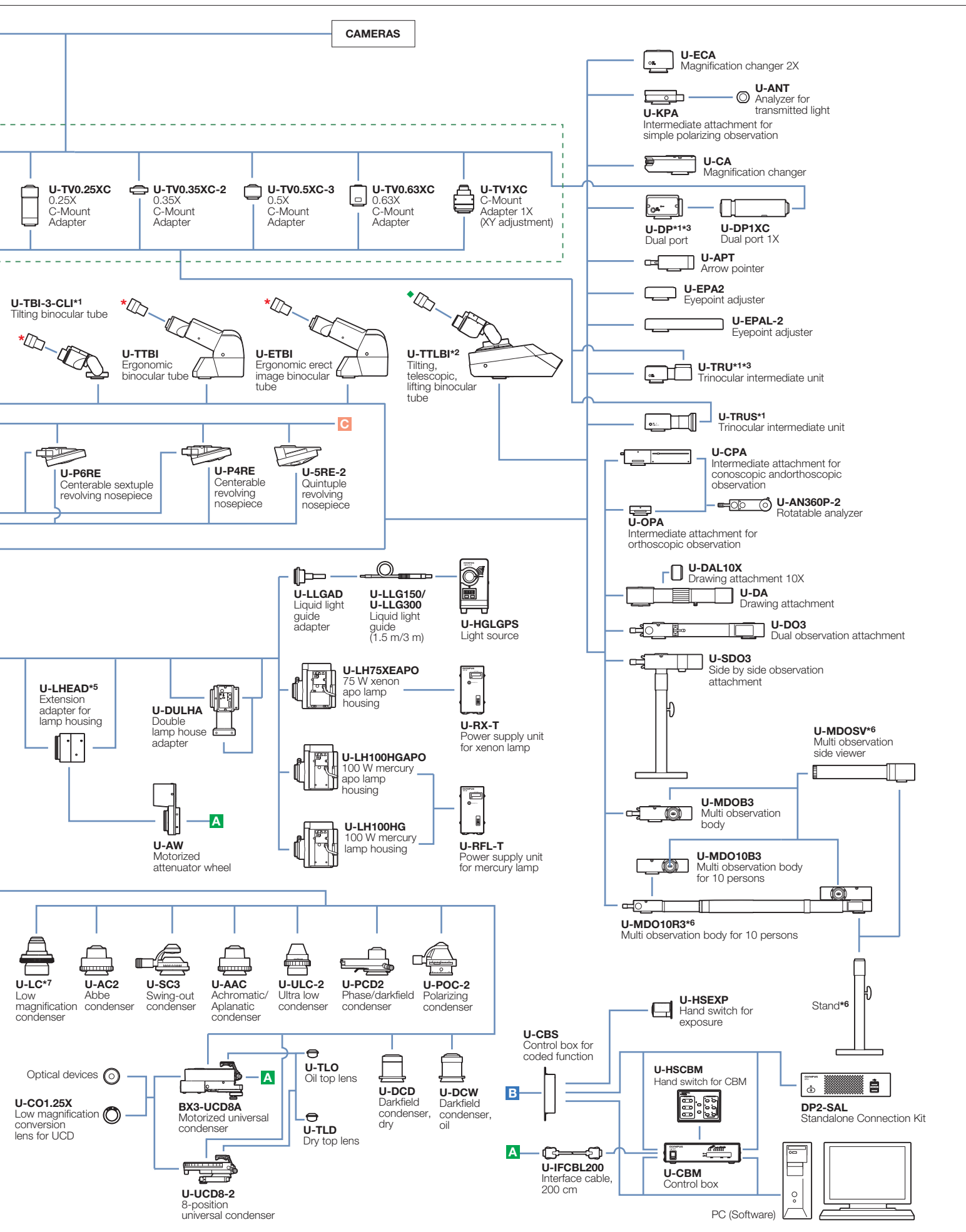

## BX63 specifications

Microscope frame	Optical system	UIS2 optical system
	Focus	Built-in motorized nosepiece focus Stroke: 20mm, minimum increment: 0.01 $\mu$ m, maximum nosepiece movement speed: 5mm/s
	Illuminator	Built-in Koehler illumination for transmitted light, Light intensity LED indicator, Built-in motorized field stop • High color reproductivity LED light source • 12V 100W halogen bulb (pre-centered)
Revolving nosepiece		• Motorized septuple revolving nosepiece • Interchangeable reversed coded sextuple/coded septuple nosepiece
Observation tube	Widefield (FN 22)	• Widefield tilting trinocular • Widefield trinocular • Widefield erect image trinocular • Widefield tilting binocular • Widefield tilting, telescopic, lifting binocular • Widefield ergo binocular • Widefield binocular
Stage		• Ultrasonic stage (Stage stroke: X: 76mm x Y: 52mm, maximum stage movement speed: 30mm/s • Ceramic-coated coaxial stage with left or right hand low drive control: with rotating mechanism and torque adjustment mechanism, optional rubber grips available • Cross stage with short left handle
Condenser		• Motorized universal condenser (NA 0.9, motorized 8-position turret, Aperture stop, polarizing filter in/out mechanism and top lens swing out mechanism), for 1.25x–100x [swing-out 1.25x–4x, with oil top lens: (NA 1.4)] • Swing out Achromatic (NA 0.9), for 1.25x–100x (swing-out: 1.25x–4x) • Achromatic Aplanatic (NA 1.4), for 10x–100x • Universal (NA 0.9), for 1.25x–100x [swing-out: 1.25x–4x, with oil top lens: (NA 1.4)] • Ultra low (NA 0.16), for 1.25x–4x • Darkfield dry (NA 0.8–0.92), for 10x–100x • Darkfield oil (NA 1.20–1.40), for 10x–100x
ND filter wheel		• Motorized 6-position ND filter wheel
Fluorescence illuminator		• Motorized multi-purpose coded type (FN 22, motorized 8-position mirror unit turret, 4-position ND slider) • Multi-purpose coded type (FN 22, 8-position mirror unit turret, 4-position ND slider)
Fluorescence light source		• 130W Hg light guide illumination • 100W Hg apo lamp housing and transformer • 100W Hg lamp housing and transformer • 75W Xe lamp housing and transformer
Controller		• High-performance control box ( I/F: FireWire)

\*This device is designed for use in industrial environments for the EMC performance. Using it in a residential environment may affect other equipment in the environment.

## BX53 specifications

Microscope frame	Optical system	UIS2 optical system
	Focus	Vertical stage movement: 25mm stage stroke with coarse adjustment limit stopper, Torque adjustment for coarse adjustment knobs, Stage mounting position variable, High sensitivity fine focusing knob (minimum adjustment gradations: 1 $\mu$ m)
	Illuminator	Built-in Koehler illumination for transmitted light, Light preset switch, Light intensity LED indicator, Built-in filters (LBD-IF, ND6, ND25), 12V 100W halogen bulb (pre-centered)
Revolving nosepiece		Interchangeable reversed quintuple/coded quintuple/sextuple/septuple/coded sextuple/coded septuple nosepiece
Observation tube	Widefield (FN 22)	• Widefield tilting, telescopic and lifting binocular • Widefield tilting trinocular • Widefield trinocular • Widefield erect image trinocular • Widefield tilting binocular • Widefield tilting, telescopic, lifting binocular tube • Widefield ergo binocular • Widefield binocular
	Super widefield (FN 26.5)	• Super widefield trinocular • Super widefield erect image tilting trinocular
Stage		Ceramic-coated coaxial stage with left or right hand low drive control: with rotating mechanism and torque adjustment mechanism, optional rubber grips available (Non stick grooved coaxial, plain, rotatable stages are also available)
Condenser		• Abbe (NA 1.1), for 4x–100x • Swing out Achromatic (NA 0.9), for 1.25x–100x (swing-out: 1.25x–4x) • Achromatic Aplanatic (NA 1.4), for 10x–100x • Phase contrast, darkfield (NA 1.1), [phase contrast: for 10x–100x, darkfield: for 10x–100x (up to NA 0.80)] • Universal (NA 0.9), for 1.25x–100x [swing-out: 1.25x–4x, with oil top lens: (NA 1.4)] • Low (NA 0.75), for 2x–100x(Dry) • Ultra low (NA 0.16), for 1.25x–4x • Darkfield dry (NA 0.8–0.92), for 10x–100x • Darkfield oil (NA 1.20–1.40), for 10x–100x
Fluorescence illuminator		• Multi-purpose coded type (FN 22, 8-position mirror unit turret, 4-position ND slider) • Economical type (FN 26.5, 8-position mirror unit turret)
Fluorescence light source		• 130W Hg light guide illumination • 100W Hg apo lamp housing and transformer • 100W Hg lamp housing and transformer • 75W Xe lamp housing and transformer

\*The U-CBM is designed for the BX3 use in industrial environments for the EMC performance. Using it in a residential environment may affect other equipment in the environment.

## BX63/BX53 common specifications

Operating environment	<ul style="list-style-type: none"> <li>• Indoor use</li> <li>• Ambient temperature : 5° to 40°C (41° to 104°F)</li> <li>• Maximum relative humidity : 80% for temperatures up to 31°C (88°F), decreasing linearly through 70% at 34°C (93°F), 60% at 37°C (99°F), to 50% relative humidity at 40°C (104°F)</li> <li>• Supply voltage fluctuations : Not to exceed <math>\pm</math>10% of the normal voltage</li> </ul>
-----------------------	--

**BX63 FL dimensions**

(unit: mm)

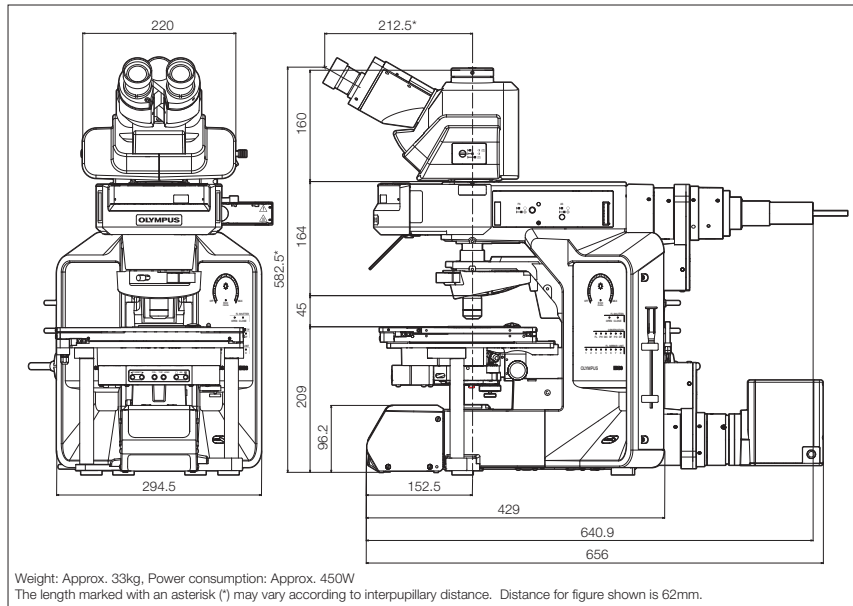

**Touch panel controller dimensions**

(unit: mm)

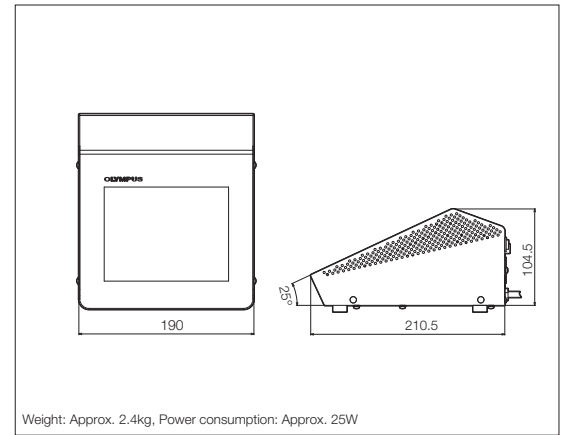

**BX53 FL dimensions**

(unit: mm)

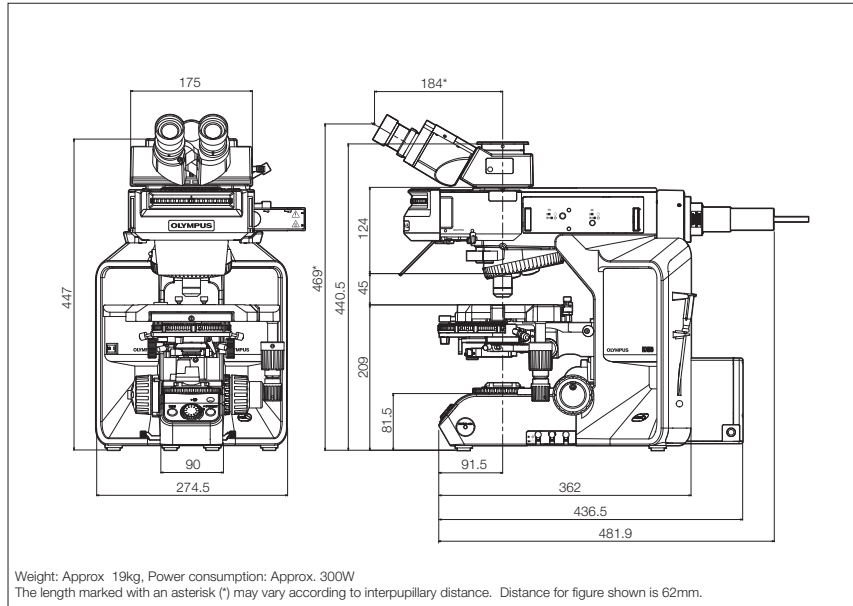

**BX3-CBH dimensions**

(unit: mm)

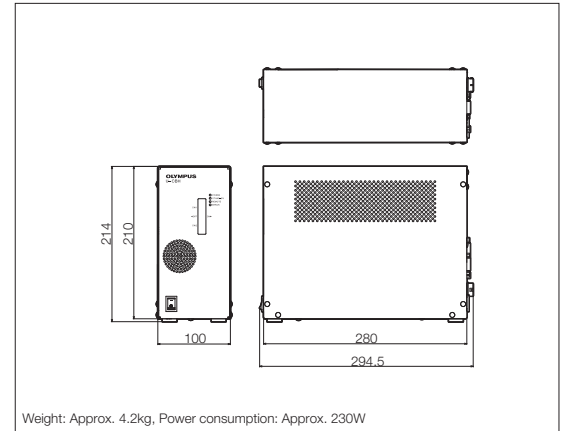

**BX53 BF dimensions**

(unit: mm)

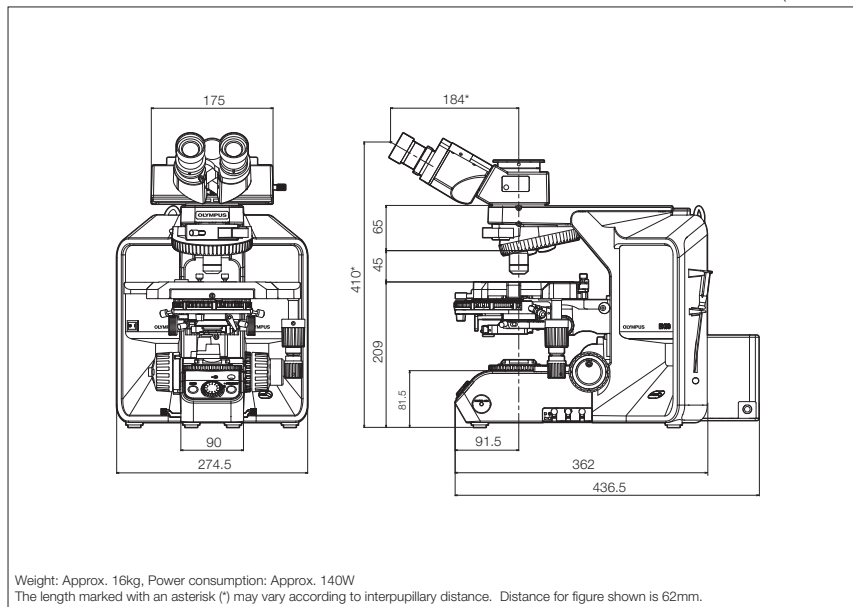

Images are courtesy of:

Hiroo Ueno, Ph.D.  
Department of Stem Cell Pathology, Kansai Medical University  
(P.3, P.15 lower)

Dr. Shigeo Hayashi, Dr. Kagayaki Kato, Dr. Reiko Tajiri and Mr. Hosen Wada  
Laboratory for Morphogenetic Signaling  
RIKEN Center for Developmental Biology  
(P.12, P.16 top left)

Shigenobu Yonemura, Ph.D.  
Electron Microscope Laboratory  
RIKEN Center for Developmental Biology  
(P.15 top right, P.17 Phase contrast, P.19 middle)

Guojun Sheng, Ph.D., Yukiko Nakaya, Ph.D.  
Laboratory for Early Embryogenesis  
RIKEN Center for Developmental Biology  
(P.2, P.16 lower left)

Fumio Matsuzaki, Ph.D., Daijiro Konno, Ph.D.  
Laboratory for Cell Asymmetry  
RIKEN Center for Developmental Biology  
(P.15 top left, P.16 top right)

Junko Kyoizuka, Associate Professor  
Graduate School of Agricultural and Life Sciences  
The Tokyo University  
(P.16 lower right)

- **OLYMPUS CORPORATION is ISO14001 certified.**
- **OLYMPUS CORPORATION is FM553994/ISO9001 certified.**
- **OLYMPUS CORPORATION is MD540624/ISO13485 certified.**
- **Illumination devices for microscope have suggested lifetimes. Periodic inspections are required. Please visit our website for details.**

- All company and product names are registered trademarks and/or trademarks of their respective owners.
- Images on the PC monitors are simulated.
- Specifications and appearances are subject to change without any notice or obligation on the part of the manufacturer.

[www.olympus-lifescience.com](http://www.olympus-lifescience.com)

**OLYMPUS®**

For enquiries - contact

[www.olympus-lifescience.com/contact-us](http://www.olympus-lifescience.com/contact-us)

**OLYMPUS CORPORATION**  
Shinjuku Monolith, 2-3-1, Nishi Shinjuku, Shinjuku-ku, Tokyo, 163-0914, Japan

**OLYMPUS EUROPA SE & CO. KG**  
Wendenstrasse 14-18, 20097 Hamburg, Germany

**OLYMPUS SCIENTIFIC SOLUTIONS AMERICAS CORP.**  
48 Woerd Avenue, Waltham, MA 02453, U.S.A.

**OLYMPUS SINGAPORE PTE LTD.**  
491B River Valley Road, #12-01/04 Valley Point Office Tower, Singapore 248373

**OLYMPUS AUSTRALIA PTY. LTD.**  
3 Acacia Place, Notting Hill VIC 3168, Australia

**OLYMPUS LATIN AMERICA, INC.**  
5301 Blue Lagoon Drive, Suite 290 Miami, FL 33126, U.S.A.

**OLYMPUS (CHINA) CO., LTD.**  
A8F, Ping An International Financial Center, No. 1-3, Xinyuan South Road, Chaoyang District, Beijing, 100027 P.R.C.

**OLYMPUS KOREA CO., LTD.**  
8F Olympus Tower, 446 Bongeunsa-ro, Gangnam-gu, Seoul, 135-509 Korea